

HIGH VOLTAGE REFERENCE MANUAL

1/2024 REV. 10

Copyright © 2024 Spellman High Voltage Electronics Corp.

TABLE OF CONTENTS

SECTION 1

FAQs High Voltage Power Supplies & Safety

ARC/Short Circuit

ARE YOUR SUPPLIES CURRENT PROTECTED?	4
WHY IS THE SHORT CIRCUIT REPETITION RATE OF MY LOAD SET-UP IMPORTANT?	4
WHAT IS THE DIFFERENCE BETWEEN INSTANTANEOUS SHORT CIRCUIT CURRENT AND CONTINUOUS SHORT CIRCUIT CURRENT?	4
WHY IS ARCING AN ISSUE FOR A HIGH VOLTAGE POWER SUPPLY?	4

Interfacing

WHAT KIND OF HIGH VOLTAGE CONNECTOR DO YOU USE ON YOUR SUPPLIES?	5
CAN I PROGRAM YOUR SUPPLIES WITH A COMPUTER?	5
WHAT DO YOU MEAN THAT THE OUTPUT SIDE OF THE HIGH VOLTAGE CABLE ON MOST STANDARD PRODUCTS IS "UNTERMINATED"?	5

Safety

WHAT IS A SAFE LEVEL OF HIGH VOLTAGE?	5
WHERE CAN I OBTAIN INFORMATION ON HIGH VOLTAGE SAFETY PRACTICES?	5
WHAT IS AN "EXTERNAL INTERLOCK"? WHY SHOULD I USE IT?	6
IEEE STD 510-1983 IEEE RECOMMENDED PRACTICES FOR SAFETY IN HIGH VOLTAGE AND HIGH POWER TESTING.	6

Technology/Terminology

WHAT IS THE DIFFERENCE BETWEEN A MODULAR SUPPLY AND A RACK SUPPLY?	8
WHAT IS THE DIFFERENCE BETWEEN VOLTAGE MODE AND CURRENT MODE?	8
VOLTAGE MODE/CURRENT MODE. WHY A POWER SUPPLY CAN ONLY REGULATE ONE OF THESE PARAMETERS AT A TIME?	9
WHAT IS POWER CONTROL? WHEN WOULD IT BE USED?	9
WHAT IS FLOATING GROUND?	9
WHAT IS SOLID ENCAPSULATION?	9
WHY IS OIL INSULATION USED?	9
WHAT IS CORONA?	10
WHAT IS A VOLTAGE MULTIPLIER?	10
WHAT IS A RESONANT INVERTER?	11
WHAT IS A HIGH VOLTAGE POWER SUPPLY?	11
LINEAR VERSUS SWITCH MODE POWER SUPPLIES?	12
WHY ARE CORONA RINGS/TOROIDS/BALLS USED ON HIGH VOLTAGE POWER SUPPLIES?	12
WHAT IS A STACK TYPE HIGH VOLTAGE POWER SUPPLY?	13
WHAT IS BALL SOLDERING?	13

Usage/Application

POSITIVE POLARITY, NEGATIVE POLARITY, REVERSIBLE POLARITY; WHY IS THIS IMPORTANT WHEN I PURCHASE A SUPPLY?	14
CAN I RUN YOUR SUPPLIES AT MAXIMUM VOLTAGE? MAXIMUM CURRENT?	14
CAN I GET TWICE THE CURRENT FROM YOUR SUPPLY IF I RUN IT AT HALF VOLTAGE?	14
WHY IS THE FALL TIME OF YOUR SUPPLIES LOAD DEPENDENT?	14
HOW SHOULD I GROUND YOUR SUPPLY?	14

CAN I FLOAT YOUR SUPPLIES?	15
CAN I OPERATE YOUR 220VAC POWER SUPPLIES AT 230VAC?	15
WHY DO I HAVE TO PROVIDE A CURRENT PROGRAMMING SIGNAL TO THE POWER SUPPLY?	15
WHY DO I HAVE TO FILL OUT A CAPACITOR CHARGING QUESTIONNAIRE IF I'M GOING TO USE YOUR POWER SUPPLY FOR CAPACITOR CHARGING?	15
WHAT ARE THE BANDWIDTH CAPABILITIES OF THE HVD SERIES OF HIGH VOLTAGE DIVIDERS?	16
WHAT IS POWER FACTOR? WHAT IS THE POWER FACTOR OF A SWITCHING POWER SUPPLY?	16
CAN I OPERATE A HIGH VOLTAGE POWER SUPPLY DESIGNED FOR 220VAC, SINGLE PHASE FROM A 208VAC, THREE PHASE ELECTRICAL SERVICE?	16

SECTION 2

Monoblock® Cooling, Seasoning/Warm-up and FAQ's

Monoblock® Cooling Recommendations	17
Monoblock® Warm-up/Seasoning Procedures	17
Monoblock® FAQ's	
Cooling	
DO I NEED TO ENSURE MY MONOBLOCK® STAYS COOL? WHY?	18
Maintenance	
WHAT PERIODIC MAINTENANCE DO I NEED TO PERFORM FOR MY MONOBLOCK®?	18
Minimum Settings	
IS THERE A MINIMUM CURRENT AND VOLTAGE I CAN SET MY MONOBLOCK® TO?	19
Mounting	
ARE THERE ANY SPECIAL CONSIDERATIONS FOR THE MECHANICAL MOUNTING OF THE MONOBLOCK®?	19
Seasoning	
HOW OFTEN DO I NEED TO SEASON MY MONOBLOCK®?	19
Dose Stability	
HOW DOES X-RAY DOSE STABILITY RELATE TO VOLTAGE/CURRENT STABILITY?	19
Long Term Storage	
IS IT OK TO KEEP A MONOBLOCK® IN STORAGE, UNUSED FOR LONG PERIODS OF TIME?	19
Tube Life	
WILL THE X-RAY TUBE LAST FOREVER?	19

SECTION 3

Application Notes HVPS

AN-01	
WHAT DO YOU MEAN; THE OUTPUT IS "GROUND REFERENCED"?	20
AN-02	
"GROUND IS GROUND", RIGHT? WHAT YOU NEED TO KNOW.	20
AN-03	
YOU WOULDN'T USE A PICKAXE FOR DENTAL SURGERY; WHEN OVER SPECIFYING A POWER SUPPLY CAN BE A BAD THING.	20
AN-04	
HOW LOW CAN YOU GO? WHY SIGNAL TO NOISE RATIOS ARE IMPORTANT IN PROGRAMMING HIGH VOLTAGE POWER SUPPLIES.	21
AN-05	
"NO, YOU TOUCH IT". HVPS OUTPUT FALL AND DISCHARGE TIMES EXPLAINED.	21

TABLE OF CONTENTS

SECTION 3
Application Notes HVPS

AN-06	22
“JUST JUMPER THE EXTERNAL INTERLOCK”? WHY YOU REALLY SHOULDN’T.	
AN-07	23
WHAT’S THE VOLTAGE RATING OF RG8-U COAXIAL CABLE?	
AN-08	23
HOW DO I CHANGE THE POLARITY OF THE POWER SUPPLY?	
AN-09	24
WHY DO POWER SUPPLIES TAKE TIME TO WARM UP?	
AN-10	25
FIXED POLARITY, REVERSIBLE POLARITY, FOUR QUADRANT OPERATION...A SIMPLE EXPLANATION.	
AN-11	25
HIGH VOLTAGE POWER SUPPLY DYNAMIC LOAD CHARACTERISTICS.	
AN-12	26
THE BENEFIT OF USING A CURRENT SOURCE TO POWER X-RAY TUBE FILAMENT CIRCUITS.	
AN-13	27
ARC INTERVENTION CIRCUITRY AND EXTERNAL SERIES LIMITING RESISTORS.	
AN-14	27
THE LIMITS OF FRONT PANEL DIGITAL METERS.	
AN-15	28
3.5 AND 4.5 DIGIT METER DISPLAYS EXPLAINED.	
AN-16	29
PARALLEL CAPABILITY OF THE ST SERIES.	
AN-17	29
HIGH VOLTAGE POWER SUPPLY PROGRAMMING RESOLUTION EXPLAINED.	
AN-18	30
CURRENT LOOP/ARC DETECTION CIRCUITRY.	
AN-19	31
KEEP IT SHORT IF YOU CAN. HIGH VOLTAGE CABLE LENGTHS DISCUSSED.	
AN-20	31
GROUNDING FOR HIGH FREQUENCY TRANSIENTS DUE TO ARCING EVENTS.	
AN-21	32
HOW TO CALCULATE MAXIMUM AC INPUT CURRENT.	
AN-22	33
SIMPLE VOLTAGE MODE/CURRENT MODE TESTING OF A HIGH VOLTAGE POWER SUPPLY.	
AN-23	34
SL HV OFF AND HV ON CIRCUITRY EXPLAINED.	
AN-24	34
ENVIRONMENTAL CONSIDERATIONS FOR SPELLMAN HIGH VOLTAGE POWER SUPPLIES, X-RAY GENERATORS AND MONOBLOCK® X-RAY SOURCES.	
AN-25	35
MY HIGH VOLTAGE POWER SUPPLY IS ARCING. HOW CAN I FIGURE OUT WHERE THE PROBLEM IS?	
AN-26	36
CAPACITOR CHARGING AND SPELLMAN HIGH VOLTAGE POWER SUPPLIES.	
AN-27	37
WHAT DOES THE FAULT “REGULATION ERROR” MEAN?	
AN-28	38
PULSING APPLICATIONS AND SPELLMAN HIGH VOLTAGE POWER SUPPLIES.	

SECTION 4
Application Notes X-Ray Generators

AN-01	39
FUNDAMENTALS OF X-RAY GENERATOR—X-RAY TUBE OPTIMIZATION.	
AN-02	41
COMMON X-RAY TUBE FAILURE MODES.	
AN-03	50
FLOATING FILAMENT X-RAY GENERATORS AND THE POSSIBLE PROBLEMS THAT LONG HIGH VOLTAGE CABLES CAN PRODUCE.	

SECTION 5
Technical Articles about HVPS & HV Electronics

Power Supply Use and Application

IEEE STD 510-1983 IEEE RECOMMENDED PRACTICES FOR SAFETY IN HIGH VOLTAGE AND HIGH POWER TESTING.	51
STANDARD TEST PROCEDURES FOR HIGH VOLTAGE POWER SUPPLIES.	53
SPECIFYING HIGH VOLTAGE POWER SUPPLIES.	64
HIGH VOLTAGE POWER SUPPLIES FOR ANALYTICAL INSTRUMENTATION.	68
HIGH VOLTAGE POWER SUPPLIES FOR ELECTROSTATIC APPLICATIONS.	72
A PRODUCT DEVELOPMENT PROCESS FOR HIGH VOLTAGE POWER SUPPLIES.	79
NEXT GENERATION IN POWER FEED EQUIPMENT.	80
HIGH VOLTAGE POWER SUPPLY TECHNOLOGY FOR USE IN POWER FEED APPLICATIONS.	84
FUNCTIONAL ROLE OF X-RAY GENERATORS IN INDUSTRIAL APPLICATIONS.	87

SECTION 6
Technical Articles about HVPS & HV Electronics

Research Papers

DESIGN AND TESTING OF A HIGH-POWER PULSED LOAD.	94
ACCURATE MEASUREMENT OF ON-STATE LOSSES OF POWER SEMICONDUCTORS.	99
HIGHLY EFFICIENT SWITCH-MODE 100KV, 100KW POWER SUPPLY FOR ESP APPLICATIONS.	104
HIGH POWER, HIGH EFFICIENCY, LOW COST CAPACITOR CHARGER CONCEPT AND IMPLEMENTATION.	110
COMPARATIVE TESTING OF SIMPLE TERMINATIONS OF HV CABLES.	122
A HIGH POWER, HIGH VOLTAGE SUPPLY FOR LONG PULSE APPLICATIONS.	130
COMPARISON OF DIELECTRIC STRENGTH OF TRANSFORMER OIL UNDER DC AND REPETITIVE MUTIMILLISECOND PULSES.	137
BEHAVIOR OF HV CABLE OF POWER SUPPLY AT SHORT CIRCUIT AND RELATED PHENOMENA IEEE TRANSACTIONS ON DIELECTRICS AND ELECTRICAL INSULATION.	147
ANALYSING ELECTRIC FIELD DISTRIBUTION IN NON-IDEAL INSULATION AT DIRECT CURRENT.	153

SECTION 7
Applications Glossary 159

SECTION 8
Technical Glossary 166

SECTION 9
GXR Glossary 188

FAQ'S HIGH VOLTAGE POWER SUPPLIES & SAFETY

ARC/SHORT CIRCUIT

Are your supplies current protected?

Virtually all of Spellman's supplies (with the exception of a few modular proportional supplies) are "current protected." Current protection is accomplished through the use of a regulating current loop, otherwise known as current mode.

The current mode is programmed to a regulating level via the front panel pot or the remote current programming signal. A current feedback signal is generated inside the supply that drives the current meter (if there is one) and the remote current monitor signal. By comparing the current feedback signal to the current program signal, the supply can limit or regulated the output current to the desired level. Even if a continuous short circuit is placed on the output of the supply, the current mode will limit the output current to the desired preset level.

Why is the short circuit repetition rate of my load set-up important?

How frequently a power supply is short circuited is an important parameter to specify when selecting a supply for a particular application.

As a rule of thumb, most of Spellman's supplies are designed to be short circuited at a 1 Hertz maximum repetition rate. This rating is dictated by the stored energy of the output section of the supply, and the power handling capability of the internal resistive output limiter that limits the peak discharge current during short circuiting. These resistive limiters (that keep the instantaneous discharge current to a limited level) thermally dissipate the stored energy of the supply during short circuiting. If a supply is arced at a repetition rate higher than it was designed for, the resistive limiters in time, may become damaged due to overheating. Brief bursts of intense arcing usually can be handled, as long as the average short circuit rate is maintained at or below 1 Hertz.

Supplies can be modified to enhance their short circuit repetition rate by reducing their internal capacitance and/or augmenting the power handling capability of the resistive output limiting assembly. Please contact the Sales Department for additional information.

What is the difference between instantaneous short circuit current and continuous short circuit current?

The output section of a typical high voltage power supply is capacitive, which causes it to store energy. When a short circuit is placed on the output of a supply, the energy stored in the capacitance of the multiplier is discharged. The only limit to the magnitude of short circuit current is the resistance in the series with the discharge circuit. All Spellman supplies have built-in output limiting assemblies

that limit the instantaneous discharge current to a limited level. The instantaneous short circuit current is determined by the setting of the output voltage divided by the resistance that is in series with the discharge path. The amount of time this discharge event is present (and its rate of decay) is determined by the amount of capacitance and resistance present in the discharged circuit.

When a short circuit is placed upon the output of a supply, there is an instantaneous short circuit current.

Once the output capacitance has been discharged, additional output current can only come from the power generating circuitry of the power supply itself. To prevent this, the power supply will sense the rise in output current due to this short circuit condition and will automatically cross over into current mode to regulate the output current to the programmed present level.

In summary, the instantaneous short circuit current is a pulse of current that discharges the capacitance of the supply, and the continuous short circuit current is the current limit level set and controlled by the current mode of the power supply.

Why is arcing an issue for a high voltage power supply?

Spellman's high voltage power supplies are designed to tolerate arcing. Individual or intermittent arcing is not problematic; but sustained long term arcing can cause output limiter overheating issues.

Spellman's high voltage output sections are capacitive by nature. To limit the current that flows during arcing an output limiting circuit is placed in series with the output of the supply. The impedance of this circuit limits the arc current to a safe and predictable level.

The capacitive high voltage output section stores energy where Joules = $\frac{1}{2} CV^2$, where C = multiplier capacitance and V = output voltage. This stored energy is dissipated as heat in the output limiter during arcing. Individual or intermittent arcing the heat can be dissipated, but sustained long term arcing can cause overheating of the output limiter.

Some Spellman units have an arc intervention circuit that sense arcing and intervenes on the power supplies behalf to prevent damage due to long sustained long term arcing. Other units do not have arc intervention and sustained long term arcing may cause overheating of the output limiter, permanently damaging the power supply.

If your application has sustained long term arcing, review your requirements with Spellman. We may be able to provide a customized unit with reduced capacitance and/or augmented output limiters to address your high arc rate application.

FAQ'S HIGH VOLTAGE POWER SUPPLIES & SAFETY

INTERFACING

What kind of high voltage connector do you use on your supplies?

While most Spellman supplies typically come with one of two types of Spellman designed high voltage connector or cable arrangements, many other industry standards (Alden, Lemo, Kings, etc.) or custom cable/connectors can be provided.

Many of our lower power modular supplies are provided with a "fly wire" output cable. This output arrangement is a length of appropriately rated high voltage wire that is permanently attached to the unit. This wire may be shielded or non-shielded, depending on model. Catalog items come with fixed lengths and non-standard lengths are available via special order.

Most higher power units, both modular and rack mounted, are provided with a Spellman-designed and fabricated, detachable, high voltage cable/connector assembly, often referred to as a Delrin Connector. Typically a deep well female connector is located on the supply and a modified coaxial polyethylene cable/connector arrangement is provided. The coaxial cable's PVC jacket and braided shield is stripped back exposing the polyethylene insulation. The length of the stripped back portion depends upon the voltage rating of the supply. A banana plug is attached to the center conductor at the end of the cable and a modified UHF or MS connector shell is used to terminate where the stripped back portion of the cable ends. This allows for a simple and reliable high voltage connection to be made to the supply. Cables can be easily connected or detached as required.

Below is a photo of a typical detachable high voltage Cable. Please contact the Sales Department for additional information regarding special high voltage connector/cable and custom lengths.

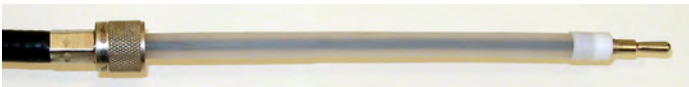

Typical Detachable High Voltage Cable

Can I program your supplies with a computer?

Yes, Spellman supplies can be programmed and controlled with a computer.

Most of Spellman's newer product releases come complete with our integrated SIC Option which provides the ability to program the unit via RS-232, Ethernet or USB protocols.

Many of our standard products that do not show the SIC Option as a possible offering on the data sheet, can in some cases be modified to have the SIC Option added to them. Please consult the Sales Department for details. Supplies that can not be provided with the SIC Option can still be computer controlled. Virtually all of our products can be remote programmed via an externally provided

ground referenced signal. In most cases 0 to 10 volts corresponds to 0 to full-scale rated voltage and 0 to full-scale rated current. Output voltage and current monitor signals are provided in a similar fashion. External inhibit signals and/or HV ON and HV OFF functioning can be controlled via a ground referenced TTL signal or opening and/or closing a set of dry contacts. More detailed information regarding interfacing is provided in the product manual.

What do you mean that the output side of the high voltage cable on most standard products is "unterminated"?

Typically, Spellman uses either a fly wire or detachable high voltage output cable to provide access to the high voltage power supplies output. A fly wire is mechanically captive to the unit, making replacement not possible. Detachable high voltage output cables allows for the simple exchange or replacement of the high voltage cable if/when required.

Yet, be it a fly wire or detachable high voltage cable; the "load end" or "customer side" of the high voltage cable is typically provided unterminated. This unterminated end of the high voltage cable has no "connector". Spellman strips back and removes the jacket and shield (if present), and removes about an inch of the primary insulation exposing the center conductor.

Our power supplies are use in a countless applications with various electrical and mechanical "high voltage connection" requirements. Therefore, Spellman lets the customer make the connection of the output side of the high voltage cable to their hardware as they see fit for their unique application.

Frequently Spellman uses a propriety deep dry well connector on the power supply side when coaxial high voltage output cables are used. Over the years, we have informally referred to this as a delrin connector, due to the fact that as some of the first versions were made out of DuPont's Delrin thermoplastic.

Spellman does not sell or provide this propriety deep dry well connector. The typical delrin connector by itself has no high voltage standoff capabilities whatsoever. Only when this connector is incorporated into an appropriate high voltage design, done so by a skilled high voltage design engineer providing the proper breakdown distances, tracking distances, Faraday shielding and processed with vacuum silicone encapsulation does our delrin connector become a functional high voltage connector with the requisite high voltage isolation capabilities.

SAFETY

What is a safe level of high voltage?

Safety is absolutely paramount in every aspect of Spellman's high voltage endeavors. To provide the maximum margin of safety to Spellman's employees and customers alike, we take the stand that there is no "safe" level of high voltage. Using this guideline, we treat every

FAQ'S HIGH VOLTAGE POWER SUPPLIES & SAFETY

SAFETY (continued)

situation that may have any possible high voltage potential associated with it as a hazardous, life threatening condition. We strongly recommend the use of interlocked high voltage Faraday Cages or enclosures, the interlocking of all high voltage access panels, the use of ground sticks to discharge any source of high voltage, the use of external interlock circuitry, and the prudent avoidance of any point that could have the slightest chance of being energized to a high voltage potential. The rigorous enforcement of comprehensive and consistent safety practices is the best method of ensuring user safety.

Where can I obtain information on high voltage safety practices?

One of the most comprehensive publications regarding high voltage safety practices is an excerpt from IEEE Standard 510-1983 known as "The IEEE Recommended Practices for Safety in High Voltage and High Power Testing." This information is available from Spellman in the form of a printed document included in our "Standard Test Procedures and Safety Practices for High Voltage Power Supplies" handout. Please contact our Sales Department for a copy.

What is an "external interlock"? Why should I use it?

An external interlock is a safety circuit provided for customer use. Most interlock circuits consist of two terminals provided on the customer interface connector. A connection must be made between these two points for the power supply to be enabled into the HV ON mode. It is strongly recommended that these interlock connections be made via fail safe electro-mechanical components (switches, contactors, relays) as opposed to semiconductor transistor devices. If the power supply is already in the HV ON mode and the connection is broken between these points, the unit will revert to the HV OFF mode.

This simple circuit allows the customer to connect their own safety interlock switch to the power supply. This switch could be an interlock connection on a HV access panel. In this way, if the panel was inadvertently opened, the high voltage would be turned off, greatly reducing the risk of bodily harm or physical injury. Spellman strongly recommends the use of interlock circuitry whenever possible.

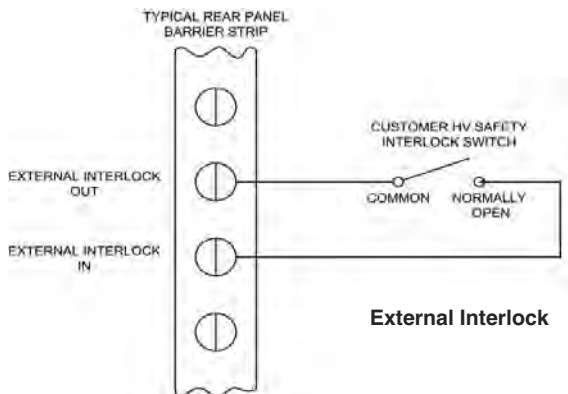

IEEE Std 510-1983 IEEE Recommended Practices for Safety in High Voltage and High Power Testing

by: The Institute of Electrical and Electronics Engineers

SCOPE

Excerpts from IEEE Standard 510-1983 have been listed in this section in order to caution all personnel dealing with high voltage applications and measurements and to provide recommended safety practices with regard to electrical hazards.

Considerations of safety in electrical testing apply not only to personnel but to the test equipment and apparatus or system under test. These recommended practices deal generally with safety in connection with testing in laboratories, in the field, and of systems incorporating high voltage power supplies, etc. For the purposes of these recommended practices, a voltage of approximately 1,000 volts has been assumed as a practical minimum for these types of tests. Individual judgement is necessary to decide if the requirements of these recommended practices are applicable in cases where lower voltages or special risks are involved.

1. All ungrounded terminals of the test equipment or apparatus under test should be considered as energized.
2. Common ground connections should be solidly connected to both the test set and the test specimen. As a minimum, the current capacity of the ground leads should exceed that necessary to carry the maximum possible ground current. The effect of ground potential rise due to the resistance and reactance of the earth connection should be considered.
3. Precautions should be taken to prevent accidental contact of live terminals by personnel, either by shielding the live terminals or by providing barriers around the area.
4. The circuit should include instrumentation for indicating the test voltages.
5. Appropriate switching and, where appropriate, an observer should be provided for the immediate deenergization of test circuits for safety purposes. In the case of dc tests, provisions for discharging and grounding charged terminals and supporting insulation should also be included.
6. High Voltage and high-power tests should be performed and supervised by qualified personnel.

TEST AREA SAFETY PRACTICES

1. Appropriate warning signs, for example, DANGER – HIGH VOLTAGE, should be posted on or near the entrance gates.
2. Insofar as practical, automatic grounding devices should be provided to apply a visible ground on the

FAQ'S HIGH VOLTAGE POWER SUPPLIES & SAFETY

SAFETY (continued)

high-voltage circuits after they are de-energized. In some high-voltage circuits, particularly those in which elements are hanged from one setup to the next, this may not be feasible. In these cases, the operator should attach a ground to the high-voltage terminal using a suitably insulated handle. In the case of several capacitors connected in series, it is not always sufficient to ground only the high voltage terminal. The exposed intermediate terminals should also be grounded. This applies in particular to impulse generators where the capacitors should be short-circuited and grounded before and while working on the generator.

3. Safe grounding of instrumentation should take precedence over proper signal grounding unless other special precautions have been taken to ensure personnel safety.

CONTROL & MEASUREMENT CIRCUITS

Leads should not be run from a test area unless they are contained in a grounded metallic sheath and terminated in a grounded metallic enclosure, or unless other precautions have been taken to ensure personnel safety. Control wiring, meter connections, and cables running to oscilloscopes fall into this category. Meters and other instruments with accessible terminals should normally be placed in a metal compartment with a viewing window.

Temporary Circuits

1. Temporary measuring circuits should be located completely within the test area and viewed through the fence. Alternatively, the meters may be located outside the fence, provided the meters and leads, external to the area, are enclosed in grounded metallic enclosures.
2. Temporary control circuits should be treated the same as measuring circuits and housed in a grounded box with all controls accessible to the operator at ground potential.

SAFETY RULES

A set of safety rules should be established and enforced for the laboratory or testing facilities. A copy of these should be given to, and discussed with, each person assigned to work in a test area. A procedure for periodic review of these rules with the operators should be established and carried out.

SAFETY INSPECTION

A procedure for periodic inspection of the test areas should be established and carried out. The recommendations from these inspections should be followed by corrective actions for unsafe equipment or for practices that are not in keeping with the required regulations.

NOTE: A safety committee composed of several operators appointed on a rotating basis has proven to be effective, not only from the inspection standpoint but also in making all personnel aware of safety.

GROUNDING & SHORTING

1. The routing and connections of temporary wiring should be such that they are secure against accidental interruptions that may create hazard to personnel or equipments.
2. Devices which rely on a solid or solid/liquid dielectric for insulation should preferably be grounded and short-circuited when not in use.
3. Good safety practice requires that capacitive objects be short-circuited in the following situations:
4. Any capacitive object which is not in use but may be in the influence of a dc electric field should have its exposed high-voltage terminal grounded. Failure to observe this precaution may result in a voltage included in the capacitive object by the field.
5. Capacitive objects having a solid dielectric should be short-circuited after dc proof testing. Failure to observe this precaution may result in a buildup of voltage on the object due to dielectric absorption has dissipated or until the object has been reconnected to a circuit.

NOTE: It is good practice for all capacitive devices to remain short-circuited when not in use.

1. Any open circuited capacitive device should be short-circuited and grounded before being contacted by personnel.

SPACING

1. All objects at ground potential must be placed away from all exposed high voltage points at a minimum distance of 1 inch (25.4 mm) for every 7,500 Volts, e.g. 50kV requires a spacing of at least 6.7 inches (171 mm)
2. Allow a creepage distance of 1 inch (25.4 mm) for every 7,500 Volts for insulators placed in contact with high voltage points.

HIGH-POWER TESTING

1. High-power testing involves a special type of high-voltage measurement in that the level of current is very high. Careful consideration should be given to safety precautions for high-power testing due to this fact. The explosive nature of the test specimen also brings about special concern relating to safety in the laboratory.
2. Protective eye and face equipment should be worn by all personnel conducting or observing a highpower test where there is a reasonable probability that eye or face injury can be prevented by such equipment.

FAQ'S HIGH VOLTAGE POWER SUPPLIES & SAFETY

SAFETY (continued)

NOTE: Typical eye and face hazards present in high-power test areas included intense light (including ultraviolet), sparks, and molten metal.

1. Safety glasses containing absorptive lenses should be worn by all personnel observing a high-power test even when electric arcing is not expected. Lenses should be impact-resistant and have shade numbers consistent with the ambient illumination level of the work area but yet capable of providing protection against hazardous radiation due to any inadvertent electric arcing.

GENERAL

1. All high-voltage generating equipment should have a single obvious control to switch the equipment off under emergency conditions.
2. All high-voltage generating equipment should have an indicator which signals that the high-voltage output is enabled.
3. All high-voltage generating equipment should have provisions for external connections (interlock) which, when open, cause the high-voltage source to be switched off. These connections may be used for external safety interlocks in barriers or for a foot or hand operated safety switch.
4. The design of any piece of high-voltage test equipment should include a failure analysis to determine if the failure of any part of the circuit or the specimen to which it is connected will create a hazardous situation for the operator. The major failure shall be construed to include the probability of failure of items that would be overstressed as the result of the major failure. The analysis may be limited to the effect of one major failure at a time, provided that the major failure is obvious to the operator.

TECHNOLOGY/TERMINOLOGY

What is the difference between a modular supply and a rack supply?

Modular supplies and rack supplies are the two generic categories into which Spellman's standard products typically fall. These product categories were created and used to help classify hardware. Additionally, Spellman provides a variety of custom and OEM supplies that would not adequately fit into either category.

Typically, rack mounted supplies are higher in power than their modular counterparts; but this is a generalization, not a rule. Rack mounted units usually operate off-line, requiring AC input. Rack mounted units usually provide full feature front panels, allowing quick and easy operator use. Spellman's rack mounted supplies comply with the EIA RS-310C rack-mounted standards.

Modular supplies tend to be lower power units (tens to hundreds of watts) housed in a simple sheet metal enclosure. Modular units that can operate off AC or DC inputs, can be provided. OEM manufacturers frequently specify modular supplies, knowing the elaborate local controls and monitors are usually not included, thus providing a cost savings. Customer provided signals, done via the remote interface connector, usually accomplishes operation, programming and control of these units.

When ease of use and flexibility is required, like in a laboratory environment, rack mounted supplies are usually preferred. Modular supplies tend to be specified by OEM users, where a single specific usage needs to be addressed in the most compact and cost effective manner possible. These are guidelines, not rules.



Module



Rack

What is the difference between voltage mode and current mode?

Voltage mode and current mode are the two regulating conditions that control the output of the supply. Most applications call for a supply to be used as a voltage source. A voltage source provides a constant output voltage as current is drawn from 0 to full rated current of the supply. In these applications, the power supply runs in voltage mode, maintaining a constant output voltage while providing the required current to the load. A voltage source is generally modeled as providing a low output impedance of the supply.

Current mode works in a similar fashion, except it limits and regulates the output current of the supply to the desired level. When the supply runs in current mode, the supply provides a constant current into a variety of load voltage conditions including a short circuit. A current source is generally modeled as providing a very high output impedance of the supply.

These two regulating modes work together to provide continuous control of the supply, but with only one mode regulating at a time. These are fast acting electronic regulating circuits, so automatic crossover between voltage mode to current mode is inherent in the design. With the programming of the voltage mode and current mode set points available to the customer, the maximum output voltage and current of the supply can be controlled under all operating conditions.

FAQ'S HIGH VOLTAGE POWER SUPPLIES & SAFETY

TECHNOLOGY/TERMINOLOGY (continued)

Voltage Mode/Current Mode. Why a power supply can only regulate only one of these parameters at a time?

Most of Spellman's high voltage power supplies offer Voltage Mode and Current Mode with automatic crossover, dependent upon settings and load conditions. This requires the power supply to have two regulating loops: voltage mode and current mode. Additionally, each loop requires a programming signal provided by the user so the power supply can regulate and limit accordingly.

Voltage Mode

Running the power supply in voltage mode is the way most customers use our power supplies. When the power supply is operated in voltage mode it behaves as a voltage source. Here the power supply will actively regulate the output voltage from 0 to 100% of the rated output voltage, dependent upon the selected setting.

In this situation the output current is determined by the magnitude of the output voltage and the impedance of the load placed upon the power supply. Most users set the Current Mode to maximum. In this situation if a short circuit were placed upon the output of the power supply it would automatically cross over from voltage mode to current mode, regulating the current at 100% of the maximum rated current.

Current Mode

Running the power supply in current mode is the less frequent way customers use our power supplies. When the power supply is operated in Current Mode it behaves as a current source. Here the power supply will actively regulate the output current anywhere from 0 to 100% of the rated output current, dependent upon the selected setting.

In this situation the output voltage is determined by the magnitude of the output current and the impedance of the load placed upon the power supply. Most users set the Voltage Mode to maximum. In this situation if an open circuit were placed upon the power supply it would automatically cross over from current mode to voltage mode, regulating the voltage at 100% of the maximum rated voltage.

Voltage Mode/Current Mode Programmability

In the above situations the voltage and current loops were set to 100% of rated output, but these signals are typically programable from 0 to 100% of rated output, as required by the customers application.

Only One Mode at a Time

As outlined above, the typical high voltage power supply can only regulate one parameter (be it voltage or current) at a time. If you run in Voltage Mode, then you have regulated voltage and current compliance. If you run in Current

Mode, you have regulated current and voltage compliance. The main point here is the power supply cannot regulate both voltage and current at the same time. If operated in Voltage Mode (as most do) the power supply will regulate the output voltage, but the current drawn from the power supply is dependent upon the voltage setting and load impedance placed on the output of the power supply in question.

What is power control? When would it be used?

Power control, (a.k.a. power mode or power loop) is a third control mode that can be added to a variety of Spellman supplies to provide another means to control and regulate the output of the supply. Voltage mode and current mode are the primary controlling modes of most units. Taking the voltage and current monitor signal and inputting them into an analog multiplier circuit, creates a power feedback signal (voltage x current = power). Using this feedback signal with an additional programmable reference signal in conjunction with error amplifier circuitry, a programmable power mode can be created.

Power control is typically used in two types of applications. The less common application is where the power into a load is the needed regulating parameter. A critical heating requirement may have very specific regulated thermal need. Using power mode, voltage and current limit levels can be established, and power mode will provide constant power to the load, immune from any impedance variations from the load itself.

The more popular usage of a power mode is in the area where a power source or load might be rated or capable of more current at reduced voltage levels, but limited to a particular power level. X-ray tubes frequently have this type of capability. If the maximum voltage were multiplied by this "increased current" capability, a power level above the rated power level would result. Power mode can address this problem by limiting the power to the maximum rated (or present) level.

What is floating ground?

The term floating ground (FG) is used to describe an option that allows for very accurate ground referenced load current measurements to be made.

Whatever current flows out of the high voltage output of a supply, must return via the ground referenced return path. This current must return back to its original source, the high voltage output section inside the supply.

The FG option isolates all of the analog grounds inside the supply and brings them to one point: usually provided on the rear of the power supply. If a current meter is connected between this FG point and chassis ground, the actual high voltage return current can be measured in a safe ground referenced fashion.

FAQ'S HIGH VOLTAGE POWER SUPPLIES & SAFETY

TECHNOLOGY/TERMINOLOGY (continued)

Essentially, the analog grounds inside the supply are "floated" up a few volts to allow for this measurement. This option is only intended to allow for a ground referenced current measurement, so the actual maximum voltage the internal analog ground "floats" to, is usually limited to 10 volts maximum.

It is important to note that all control and monitoring circuitry are also floated on top of the FG terminal voltage. Users of this option must provide isolation from the FG terminal to chassis ground. Higher voltages may be available depending on the model selected. Please contact our Sales Department for more information.

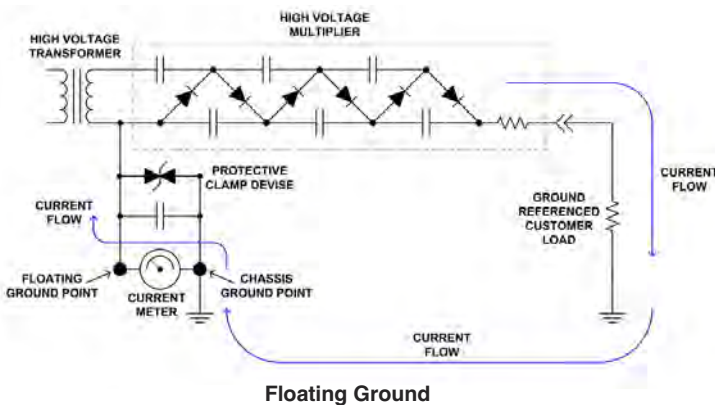

What is solid encapsulation?

Solid encapsulation, also referred to as "potting," is an insulation media used in a variety of Spellman's supplies. The "output section" of a high voltage power supply can operate at extremely high voltages. The design and packaging of the high voltage output section is critical to the functionality and reliability of the product.

Solid encapsulation allows Spellman designers to miniaturize the packaging of supplies in ways that are unobtainable when utilizing air as the primary insulating media alone. Improved power densities result, providing the customer with a smaller, more compact supply.

Additionally, solid encapsulation provides the feature of sealing off a potted output section from environmental factors. Dust, contamination, humidity and vibration typically will not degrade or affect the performance of an encapsulated high voltage output section. This is especially important where a supply will operate in a harsh environment, or where a unit must operate maintenance free.

Why is oil insulation used?

Spellman has invested in and developed the use of oil insulation technology, giving its engineers and designers,

when appropriate, another method of high voltage packaging technology. Oil, as an insulating media has some distinct advantages in particular situations. This capability has been utilized in several of Spellman's MONOBLOCK® designs, where a power supply and an X-ray tube assembly have been integrated into a single unit. The results of this integration include a reduction of the size and weight of a unit, in addition to providing excellent heat transfer characteristics and eliminating costly high voltage cables and connectors.

What is corona?

Corona is a luminous, audible discharge that occurs when there is an excessive localized electric field gradient upon an object that causes the ionization and possible electrical breakdown of the air adjacent to this point. Corona is characterized by a colored glow frequently visible in a darkened environment. The audible discharge, usually a subtle hissing sound, increases in intensity with increasing output voltage. Ozone, an odorous, unstable form of oxygen is frequently generated during this process. Rubber is destroyed by ozone, and nitric acid can be created if sufficient moisture is present. These items have detrimental affects on materials, inclusive of electrical insulators.

A good high voltage design takes corona generation into account and provides design countermeasures to limit the possibility of problems developing. Spellman engineers use sophisticated e-field modeling software and a Biddle Partial Discharge Detector to ensure that each high voltage design does not have excessive field gradients, preventing partial discharge and corona generation.



Corona

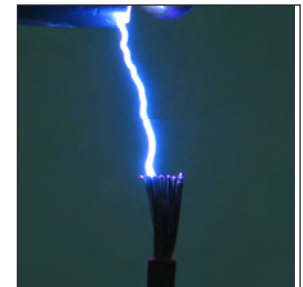

Corona and Breakdown

What is a voltage multiplier?

A voltage multiplier circuit is an arrangement of capacitors and rectifier diodes that is frequently used to generate high DC voltages. This kind of circuit uses the principle of charging capacitors in parallel, from the AC input and adding the voltages across them in series to obtain DC voltages higher than the source voltage. Individual voltage multiplier circuits (frequently called stages) can be connected in series to obtain even higher output voltages.

FAQ'S HIGH VOLTAGE POWER SUPPLIES & SAFETY

TECHNOLOGY/TERMINOLOGY (continued)

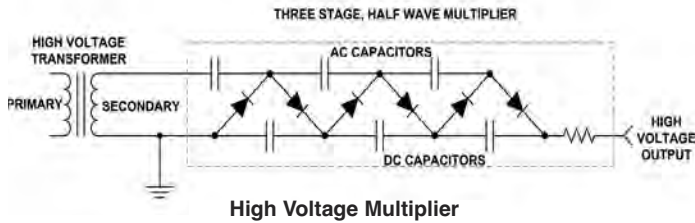

Spellman has pioneered the use of voltage multiplier circuits at extreme voltage and power levels. Spellman's engineers have repeatedly broken limits normally associated with this type of circuit.

What is a resonant inverter?

A resonant inverter is the generic name for a type of high frequency switching topology used in many of Spellman's supplies. Resonant switching topologies are the next generation of power conversion circuits, when compared to traditional pulse width modulation (PWM) topologies.

Resonant-based supplies are more efficient than their PWM counterparts. This is due to the zero current and/or zero voltage transistor switching that is inherent in a resonant supplies design. This feature also provides an additional benefit of eliminating undesirable electromagnetic radiation normally associated with switching supplies.

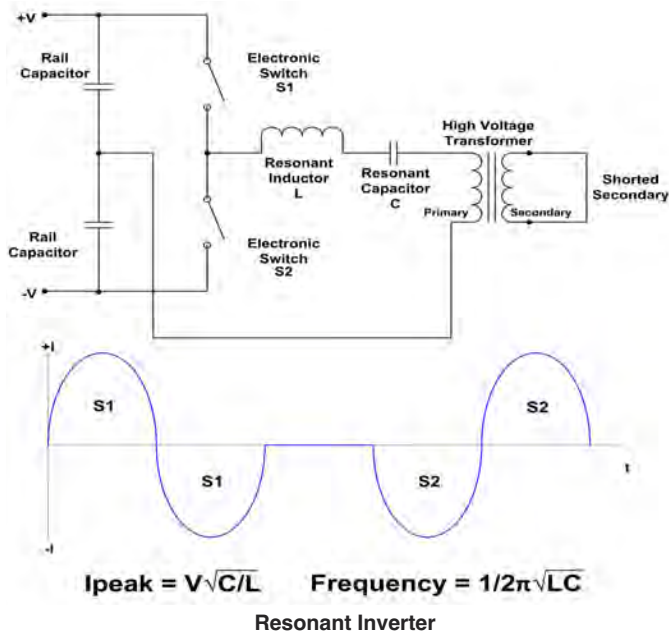

What is a high voltage power supply?

A high voltage power supply is a complex power conversion circuit that converts a lower voltage potential to a higher voltage potential. The term "high voltage" is relative not quantitative, but once voltages are above 62Vdc the possibility for bodily harm are present so appropriate safety measures must be used. Typical output voltages for Spellman's high voltage power supplies are 1kV to 360kV, but ranges of 62V to 500kV are provided.

High voltage power supplies can operate from DC or AC input voltages. DC input voltages are economical to use in low power applications (1 watt to 125 watts). Typical DC input voltage are +12Vdc and +24Vdc. AC input high voltage power supplies can operate off a variety of input voltages ranging from 100Vac to 480Vac, single phase or three phase depending upon design. Power factor corrected/universal input high voltage power supplies can operate off 90 to 264Vac with no user intervention required.

Spellman's range of output power spans from less than a watt to over 200 kilowatts. The high voltage power supplies we offer fall into the following categories:

- Modular High Voltage Power Supply
- Rack Mount High Voltage Power Supply
- X-Ray Generator
- X-Ray Source (Monoblock®)
- Custom High Voltage Power Supply
- Application Specific High Voltage Power Supply
- Portable NDT X-Ray Imaging Products

The polarity of the DC high voltage power supply must be considered. Units with a fixed positive polarity, fixed negative polarity or reversible polarity are available. Some application specific power supplies can electronically reverse their output polarity with the flip of a switch or remote control signal.

The output of the high voltage power supply is provided to the customer via an appropriately rated high voltage cable. Smaller, economical units utilize a permanently attached high voltage fly wire, while larger units use a detachable shielded coaxial high voltage cable.

Spellman's custom and application specific high voltage power supplies are used in a wide range of applications

- Mass Spectrometry
- Electron and Ion Beam Sources
- Power Feed Equipment
- Capillary Zone Electrophoresis
- Electrospinning
- Capacitor Charging
- Electrostatic Chucks
- Image Intensifiers and Magnetrons

FAQ'S HIGH VOLTAGE POWER SUPPLIES & SAFETY

TECHNOLOGY/TERMINOLOGY (continued)

Spellman's offers high voltage power supplies for a wide range of industries

- Security Screening
- Medical Imaging
- Analytical Instruments
- Inspection
- Semiconductor
- Industrial Processes
- Environmental
- Undersea Power
- Custom Products
- Research

Spellman High Voltage Electronics is the world's leading provider of high voltage power supplies, custom and standard DC high voltage power converters and Monoblock® X-Ray sources for medical, industrial, semiconductor, security, analytical, laboratory and under-sea cable power-feed applications. As a global supplier with strategically located design and manufacturing facilities in North America, Europe and Asia, Spellman is committed to providing best-in-class support to OEM customers and end-users throughout the world.

Linear versus Switch Mode Power Supplies

Linear High Voltage Power Supplies

Linear power supplies were the dominant technology up until the late 1970's. A linear power supply makes use a series pass transistor to function as a variable resistor as the main method of regulating the output of the power supply. When full output is required from the power supply, the series pass transistor is turned on such that it had the least resistance and the maximum power flows to the output. If less than full output is required the series pass transistor would be operated as a variable resistor, dissipating the unneeded power as heat to achieve the desired output.

The pass transistor being operated as a dissipative device requires large heatsinks and often fans to maintain acceptable operating temperatures. Essentially a linear power supply just wastes the power not required as heat. Because of this fact linear power supplies tended to be large, heavy, bulky units with very poor efficiencies. Additionally, linear power supplies are limited in overall power output capability due to the problems of heat dissipation caused by their inherent poor efficiencies. Linear power supplies do have a notable benefit, they tend to be very quiet in terms of output noise and ripple since no switching element is used for their regulation. All the standard product Bertan branded high voltage power supplies Spellman sold in the past were linear power supplies. Virtually all these older Bertan units are now obsolete, not being sold or supported by Spellman anymore.

Switch Mode High Voltage Power Supplies

Switch Mode power supplies are called as such because they use transistors as "switching regulators". The linear power supply uses a transistor as a variable resistor (the transistor is partially on, dissipating large amounts of power), while the switching regulator uses transistor switch(s) that are either fully ON or fully OFF. When the transistor is fully ON and current is flowing the voltage drop across it is minimal. When the transistor is OFF, no current flows through it, the power dissipation is essentially zero.

Output regulation of the power supply is achieved by varying the ratio of ON to OFF time done at a high switching frequency (tens to hundreds of kilohertz) as to minimize the size of magnetic and capacitive components used in the power conversion process. Due to these facts switch mode power supplies can be made very small, compact, and highly efficient when compared to their linear counterparts. Extremely high power levels, to hundreds of kilowatts can be very efficiently controlled using switch mode power conversion techniques.

Because of the switching regulator operating frequency there tends to be more ripple and noise on the output when compared to traditional linear regulator. But due to all the other benefits that switch mode power supplies provide they have become the dominate form of power conversion technology in use today.

Why are corona rings/toroids/balls used on high voltage power supplies?

Spellman makes high voltage DC power supplies with output voltage up to and beyond 360kV. At these extreme high voltages the physical geometry of the surfaces at high voltage becomes a critical consideration with respects to suppressing the generation of corona. Corona is a luminous, audible discharge that occurs when there is an excessive localized E-Field gradient upon an object that causes the ionization and possible electrical breakdown of the air adjacent to this point. Effective corona suppression is a crucial factor to take into account when designing high voltage power supplies.

The large diameter, smooth spherical shapes of corona rings/toroids/balls helps to control the local E-Field, thereby suppressing the generation of corona. As the output voltage increases the diameter of the required corona ring/toroid/ball must also increase to obtain effective corona suppression. Spellman has decades of experience in corona suppression techniques, uses sophisticated E-Field modeling software and partial discharge measurement equipment to assure our power supplies designs provide effective corona suppression, regardless of output voltage.

FAQ'S HIGH VOLTAGE POWER SUPPLIES & SAFETY

TECHNOLOGY/TERMINOLOGY (continued)

What is a "stack" type high voltage power supply?

The SLS is a subcategory of Spellman's SL Series, which offer output voltage from 160kV to 360kV (and beyond via special order) via a separate high voltage assembly commonly referred to as a "stack". The necessity of the stack is simple, as output voltages increase economical and reliable cable/connector assemblies become less available and more problematic to incorporate. The simple solution is to remove the cable/connector assembly and to make the output voltage available via separate air insulated high voltage stack assembly. Large corona rings and/or toroids are typically used to suppress corona generation at these extreme output voltages. SLS units have two basic assemblies: the control rack and the air insulated high voltage stack assembly.



What is Ball Soldering?



Ball soldering is a soldering technique frequently used in the high voltage industry. Large spherical balls of solder are used to make solder connections that are typically "at high voltage". The large diameter, smooth spherical shape of the solder connection helps to control the local E-Field, suppressing the generation of corona.

The solder connection must be a solid mechanical joint as well as an effective corona suppression device. If it fails at either of these requirements it is not acceptable ball soldering. Making a good ball solder joint requires experience with the materials, solder time, temperature and technique. Typically trying to touch up a ball solder joint rarely improves a connection so this must be looked upon as a "do it right the first time" type of solder connection.

FAQ'S HIGH VOLTAGE POWER SUPPLIES & SAFETY

USAGE/APPLICATION

Positive polarity, negative polarity, reversible polarity; why is this important when I purchase a supply?

DC sources are polarity specific. Using earth ground as a reference point, the output of a DC supply can be "X" number of volts above ground (positive polarity) or "X" number of volts below ground (negative polarity). Another way of explaining this, is as a positive supply can source (provide) current, while a negative supply can sink (accept) current. Applications that require DC high voltage sources are polarity specific, so the polarity required must be specified at the time of order.

Can I run your supplies at maximum voltage? Maximum current? How much should I de-rate your supplies?

Spellman standard supplies can be run at maximum voltage, maximum current, and maximum power continuously with no adverse affect on performance or reliability. Each supply we sell is burned in at full rated voltage and full rated current for a minimum of 12 hours. All of our supplies are designed to meet a set of Spellman Engineering Design Guidelines that dictate all appropriate internal component deratings. Designing to these guidelines provides a supply with more than adequate margins, so there is no need to derate our supplies below our specifications.

Can I get twice the current from your supply if I run it at half voltage?

Most of our unmodified products (with the exception of several X-ray generators) obtain maximum rated power at maximum rated voltage and maximum rated current. Where more current is needed at lower voltages, we can provide a custom design for your particular application. Please contact our Sales Department to see how we can satisfy your requirement.

Why is the fall time of your supplies load dependent?

A high voltage power supply's output section is capacitive by design. This output capacitance gets charged up to the operating voltage. When the supply is placed in HV OFF or standby (or turned off entirely) this charged output capacitance needs to be discharged for the output voltage to return back to zero.

Most high voltage output sections use diodes in their output rectification or multiplication circuitry. The diodes are orientated to provide the required output polarity. A diode only allows current to flow one way. In a positive supply, current can only flow out of the supply. Because the supply can't sink current, the charged output capacitance needs to be bled off into the customer's load or some other discharge path.

Our positive supplies actually do have a small amount of "current sink" capability provided by the resistance of the voltage feedback divider string, located inside the supply. An extremely high value of resistance is necessary (typically tens or hundreds of meg-ohms, or even gig-ohms) so the output capacitance will bleed off to zero volts, in seconds or tens of seconds in a "no load" condition. For this reason, the fall time of our supplies are load dependent.

How should I ground your supply?

Grounding is critical to proper power supply operation. The ground connection establishes a known reference potential that becomes a baseline for all other measurements. It is important that grounds in a system are low impedance, and are connected in such a way that if currents flow through ground conductors they do not create voltage level changes from one part of the system to another.

The best way to minimize the possibility of creating voltage differences in your system grounding is to use ground planes via chassis and frame connections. Since the source of the high voltage current is the power supply, it is recommended that it be the tie point for system grounds to other external devices.

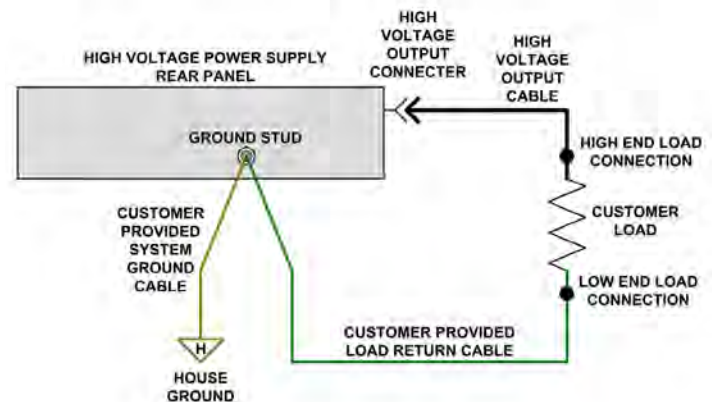

Power Supply Grounding

The rear panel of the power supply should be connected to this system ground in the most direct, stout manner possible, using the heaviest gauge wire available, connected in a secure and durable manner. This ties the chassis of the supply to a known reference potential. It is important to understand most damage to HV power supplies occur during load arcing events. Arcing produces very high transient currents that can damage power supply control circuitry (and other system circuitry) if grounding is not done properly. The product manual provides more detailed information regarding grounding requirements. If you have any additional questions, please contact the Sales Department.

FAQ'S HIGH VOLTAGE POWER SUPPLIES & SAFETY

USAGE/APPLICATION (continued)

Can I float your supplies?

Spellman's standard products are for the most part, designed and intended for use as ground referenced power supplies. That is, only one high voltage output connection is provided, while the current return path is made via the customer-provided ground referenced load return wiring. This load return must be connected to a reliable earth ground connection for proper operation and transient protection.

Many applications do exist, like ion beam implantation, which require supplies to operate at reference voltages other than earth ground. A supply of this nature is said to "float" at some other reference potential. If your application requires a floating power supply, please contact our Sales Department to review your requirement.

Can I operate your 220Vac power supplies at 230Vac?

The simple answer is yes... in most cases you can.

220Vac $\pm 10\%$ ranges from a low of 198Vac, and to a high of 242Vac. 230Vac $\pm 10\%$ ranges from a low of 207Vac to a high of 253Vac.

The "low end" of 230Vac -10% is 207Vac; this is inside the normal range of 220Vac -10% (which is 198Vac), so there's no problem on the low end of the input voltage range.

The "high end" of 230Vac +10% is 253Vac. This is only 11 volts above the 220Vac +10% upper range of 242Vac. Spellman's high voltage power supplies units are designed with ample voltage margins present on the AC input components to accommodate this minor increase in input voltage.

Why do I have to provide a current programming signal to the power supply?

Spellman's power supplies have two regulating loops, voltage mode and current mode. Most people use our power supplies as a voltage source, controlling and regulating the output voltage in voltage mode.

The current loop of the power supply will limit the current drawn during a short circuit condition to whatever level the current loop (current programming) is set to.

To use the power supply as a voltage source most users set the current limit to maximum and control the voltage programming signal to obtain the desired output voltage. Operated in this manner the unit will function as a voltage source being able to provide programmable and regulated voltage (from 0 to 100% of rated output voltage) up to the unit's maximum current compliance capability. If a

short circuit occurs the unit will cross over into current mode and limit the output current at the unit's maximum rated current.

If the current loop is mistakenly programmed to zero by leaving the current programming signal disconnected or left at zero, you are telling the power supply to provide "zero" current. The power supply will be happy to provide zero current, by providing zero output voltage. There is nothing actually wrong here with the power supply, the unit is just doing what it is told.

So if you have a power supply that "doesn't provide any output voltage, even though you have the unit enabled and are dialing up the voltage programming...stop and see where the current programming is set. If the current programming is set to zero, you have found your problem.

Spellman's rack mount units like the SL, SA, SR and ST have a handy "programming preset feature". With the unit turned on and in standby, press in and hold the green front panel HV OFF button. With this done (no high voltage is being generated) the front panel digital voltage and current meters will display the user programmed kV and mA levels that the voltage loop and current loop are being provided in actual kV and mA. This is a simple way to check and confirm the programmed voltage and current levels provided to the power supply.

Why do I have to fill out a capacitor charging questionnaire if I'm going to use your power supply for capacitor charging?

A DC high voltage power supply can address some capacitor charging applications, but not all. When charge repetition rates exceed once per second or so, an application specific cap charger product is often required. If a standard DC power supply is subjected to a high repetition rate, it is possible to thermally overload the output circuitry. In addition, performance characteristics for optimum cap charging may not be obtained. The capacitor charging questionnaire allows the engineers at Spellman to review your application and see if we have a hardware solution for your requirement.

All capacitor charging applications need to be reviewed via the information provided by the capacitor charging questionnaire. We may find that a standard unit will work fine for your application. Or we may recommend that a standard unit be customized (reduce internal capacitance, augment arc limiting circuitry, etc.) to meet a particular application. Or we may conclude that we don't have a hardware solution for this particular requirement. In any event, for capacitor charging applications please fill out the cap charging questionnaire and let Spellman recommend the appropriate solution for your application.

FAQ'S HIGH VOLTAGE POWER SUPPLIES & SAFETY

USAGE/APPLICATION (continued)

What are the bandwidth capabilities of the HVD Series of High Voltage Dividers?

The HVD Series of high voltage dividers are intended for DC high voltage measurements only. These dividers are fabricated with only resistive elements. The parasitic capacitive effects on the divider assembly make the AC capability of the HVD basically unspecified. Only DC conditions can be accurately measured with the HVD Series of high voltage dividers. For this reason the HVD data sheet contains the note:

“The HVD Series of high voltage dividers have no inferred bandwidth measurement capability what so ever. They are intended for DC steady state measurement only.”

What is power factor? What is the power factor of a switching power supply?

Power factor is the ratio of the real power to apparent power utilized. It is typically expressed as a decimal number less than 1. Real power is expressed in watts while apparent power is expressed in VA (volt-amperes). The power factor of a switching power supply depends upon what type of AC input is used: single phase, three phase, or active power factor corrected.

Single phase uncorrected switching power supplies typically have fairly poor power factor, like 0.65. This is because most units utilize a rectifier/capacitor “front end” to make a DC buss voltage. This configuration only draws current at the peak of each line cycle, creating narrow, high pulses of current which results in poor power factor.

Three phase uncorrected switching power supplies have a higher power factor, like 0.85. This is because even though a rectifier/capacitor is used to make a DC buss voltage, there are three phases which additively improves the overall power factor.

Units with active power factor correction circuitry can have very good power factor like 0.98. Essentially a front end converter is used in boost mode to make the line current draw mimic the line voltage, dramatically increasing the power factor.

Why is power factor important? Uncorrected units tend to limit what power you can get out of a particular electrical service. All line cords, circuit breakers, connectors and electrical services must be rated for the maximum current drawn. With uncorrected power supplies this tends to limit the actual power that can be provided from a particular service. When an active power factor corrected power

supply is used the maximum line currents are much lower, allowing more current to be utilized by the supply and higher power supply output power can be provided by the same electrical service.

Additionally harmonic noise imposed by the power supply to the AC line can also be lower. Another benefit is active power factor correction can provide universal input voltage capability, allowing power supplies to operate worldwide on a wide range of input voltages like 88Vac to 264Vac. Power factor corrected units, they certainly have some benefits.

Can I Operate a high voltage power supply designed for 220Vac, single phase from a 208Vac, three phase electrical service?

The simple answer is yes, if you connect any two phases of the 208Vac electrical service to the two AC input wires (solid brown and solid blue) you can operate the power supply. Connect the green/yellow wire to ground and ground the power supply properly along with making the required load return connections. But this simple answer needs some qualification.

220Vac, single phase has a typical tolerance of $\pm 10\%$, so that means the low end could go to 200Vac. 208Vac, three phase also has a typical tolerance of $\pm 10\%$, that means the low end could go to 187Vac. This is 13 volts lower than the “low end” of 220Vac, which is 200Vac. So it is possible that if using 208Vac to power a unit designed for 220Vac the input line could fall lower than the specified input voltage.

Is this a problem? It could be, but it's possible it will not be an issue. The only time this situation could be problematic would be if the unit is being used at maximum voltage or maximum current...providing maximum power. Then if the input voltage falls below the 200Vac level the unit could possibly “drop out of regulation” creating a Regulation Error fault. The power supply will stop generating high voltage, it will not be damaged but this shut down could present process interruptions. If you are not using the power supply at maximum voltage/maximum current and maximum power than most likely the power supply will not create this fault condition.

MONOBLOCK® COOLING, SEASONING/WARM-UP and FAQ's

MONOBLOCK COOLING RECOMMENDATIONS

For convection/forced air cooled Monoblock® units:
 The Monoblock® is designed to operate in an ambient temperature of 0-40 degrees C. For maximum performance and reliability, it is important that sufficient cooling is provided in order to maintain the oil temperature of the Monoblock® at or below 55 degrees C. Convection cooling may be sufficient. However in some applications an external cooling fan (to be provided by the user) may be necessary in order to maintain the oil temperature of the Monoblock® at or below 55 degrees C. Please reference Figure 1 below for suggested fan placement.

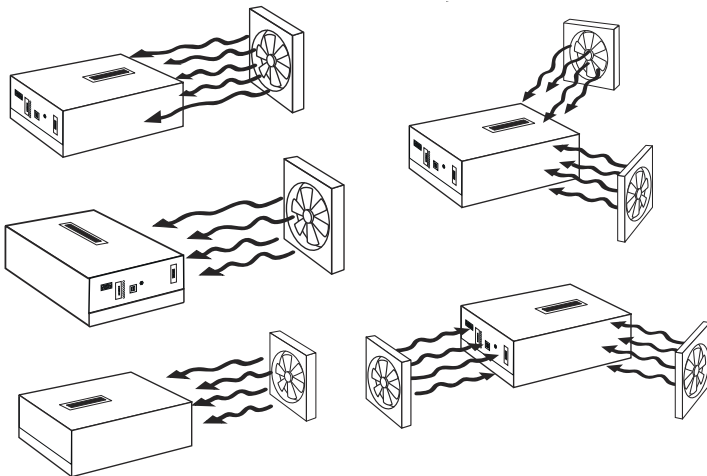

Figure 1

For Monoblock® units with integrated cooling system:
 The Monoblock® is equipped with an integrated cooling system and is designed to operate in an ambient temperature of 0-40 degrees C. For maximum performance and reliability it is important that the ambient operating temperature of the Monoblock® is maintained at or below 40 degrees C. Preventative maintenance is recommended in order to keep the fan(s) and heat exchanger free from dust and debris.

WARM-UP/SEASONING PROCEDURE

After initial installation and/or after periods of idle time (Idle time is defined as X-ray output being disabled), Spellman High Voltage recommends the following warm-up schedules are followed. This ensures proper operation for the X-ray Tube. Disregarding this may cause irreversible damage to the X-ray tube and/or decrease life expectancy.

For units with a maximum output current of less than 2.5mA, a minimum warmup current of .3mA should be used. See 160kV, 1.25mA example on next page.

- | | |
|----------------------|--|
| Idle time >12hrs | Daily warm-up (approx. 120 seconds) |
| Idle time 2-30 days | Short warm-up (approx. 360 seconds) |
| Idle time 1-3 months | Long warm-up (approx. 720 seconds) |
| Idle time >3 months | Extended warm-up (approx. 60 minutes) |

NOTES:

- Below are general warm-up charts. Always use the chart supplied for your specific Monoblock. When in doubt, contact Spellman for assistance
- If there is arcing during seasoning, WITHOUT a fault/shutdown, continue on through the whole profile
- If there is arcing during seasoning, WITH a fault/shutdown, reset the Monoblock and start the profile over from Step 1.

Daily Warm-up

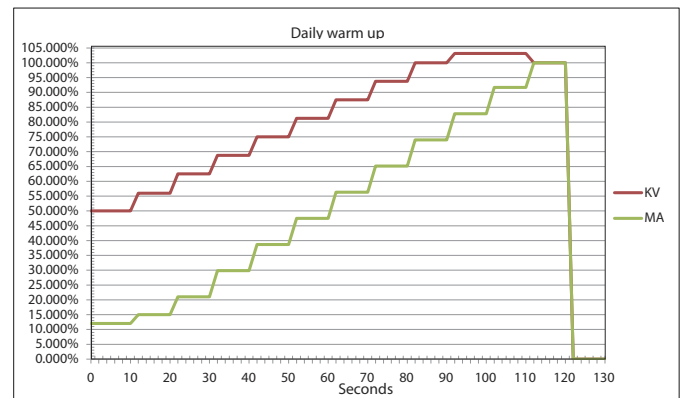

Daily warm-up												
	Step 1	Step 2	Step 3	Step 4	Step 5	Step 6	Step 7	Step 8	Step 9	Step 10	Step 11	Step 12
Voltage (kV)	50.00%	56.00%	62.50%	68.75%	75.00%	81.25%	87.50%	93.75%	100.00%	103.12%	103.12%	100.00%
Current (mA)	12.00%	15.00%	21.00%	29.83%	38.66%	47.50%	56.30%	65.16%	74.00%	82.83%	91.66%	100.00%
Time (Seconds)	10	10	10	10	10	10	10	10	10	10	10	10

MONOBLOCK® COOLING, SEASONING/WARM-UP and FAQ's

WARM-UP/SEASONING PROCEDURE (continued)

Short Warm-up

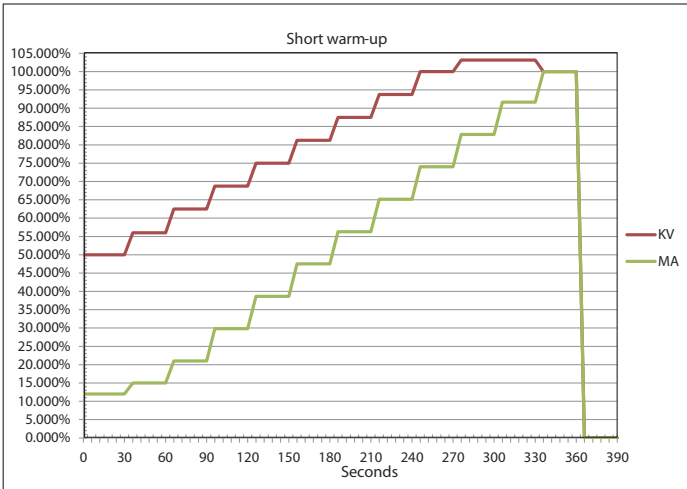

Short warm-up												
	Step 1	Step 2	Step 3	Step 4	Step 5	Step 6	Step 7	Step 8	Step 9	Step 10	Step 11	Step 12
Voltage (kV)	50.00%	56.00%	62.50%	68.75%	75.00%	81.25%	87.50%	93.75%	100.00%	103.12%	103.12%	100.00%
Current (mA)	12.00%	15.00%	21.00%	29.83%	38.66%	47.50%	56.30%	65.16%	74.00%	82.83%	91.66%	100.00%
Time (Seconds)	30	30	30	30	30	30	30	30	30	30	30	30

Long Warm-up

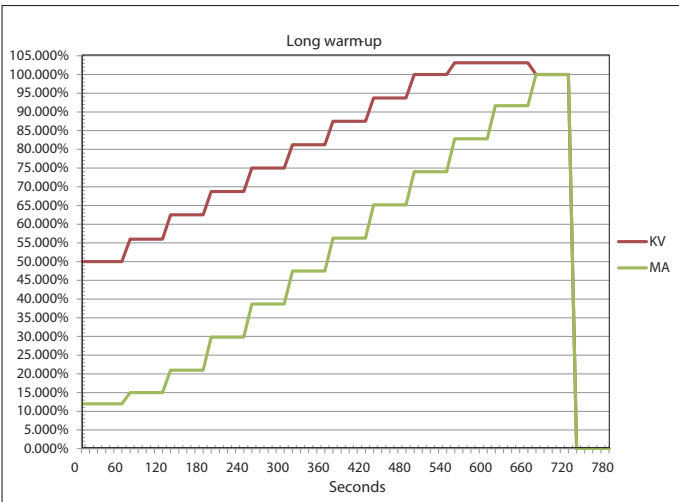

Long warm-up												
	Step 1	Step 2	Step 3	Step 4	Step 5	Step 6	Step 7	Step 8	Step 9	Step 10	Step 11	Step 12
Voltage (kV)	50.00%	56.00%	62.50%	68.75%	75.00%	81.25%	87.50%	93.75%	100.00%	103.12%	103.12%	100.00%
Current (mA)	12.00%	15.00%	21.00%	29.83%	38.66%	47.50%	56.30%	65.16%	74.00%	82.83%	91.66%	100.00%
Time (Seconds)	60	60	60	60	60	60	60	60	60	60	60	60

Extended Warm-up

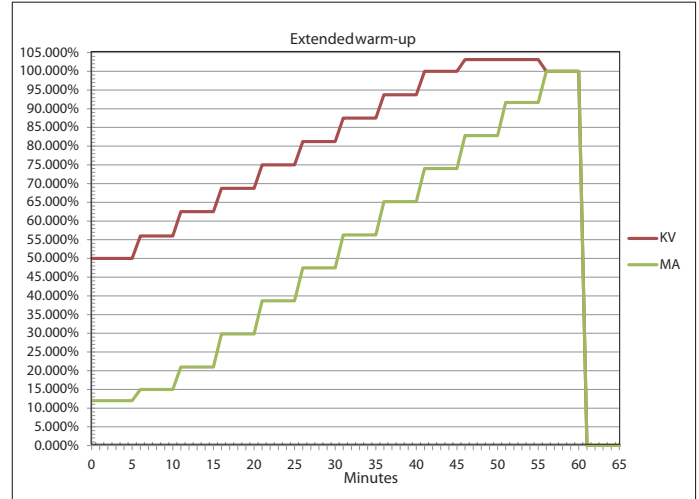

Extended warm-up												
	Step 1	Step 2	Step 3	Step 4	Step 5	Step 6	Step 7	Step 8	Step 9	Step 10	Step 11	Step 12
Voltage (kV)	50.00%	56.00%	62.50%	68.75%	75.00%	81.25%	87.50%	93.75%	100.00%	103.12%	103.12%	100.00%
Current (mA)	12.00%	15.00%	21.00%	29.83%	38.66%	47.50%	56.30%	65.16%	74.00%	82.83%	91.66%	100.00%
Time (Minutes)	5	5	5	5	5	5	5	5	5	5	5	5

An example of an Extended Warm-up for a 160kV, 1.25mA unit:

Extended warm-up												
	Step 1	Step 2	Step 3	Step 4	Step 5	Step 6	Step 7	Step 8	Step 9	Step 10	Step 11	Step 12
Voltage (kV)	80.0	89.6	100.0	110.0	120.0	130.0	140.0	150.0	160.0	165.0	165.0	160.0
Current (mA)	0.300	0.300	0.300	0.373	0.483	0.594	0.704	0.815	0.925	1.035	1.146	1.250
Time (Minutes)	5	5	5	5	5	5	5	5	5	5	5	5

*Minimum warmup current of .300ma

An example of an Extended Warm-up for a 160kV, 3mA unit:

Extended warm-up												
	Step 1	Step 2	Step 3	Step 4	Step 5	Step 6	Step 7	Step 8	Step 9	Step 10	Step 11	Step 12
Voltage (kV)	80.000	89.600	100.000	110.000	120.000	130.000	140.000	150.000	160.000	164.992	164.992	160.000
Current (mA)	0.360	0.450	0.630	0.895	1.160	1.425	1.689	1.955	2.220	2.485	2.750	3.000
Time (Minutes)	5	5	5	5	5	5	5	5	5	5	5	5

MONOBLOCK® FAQ'S

Do I need to ensure my Monoblock® stays cool?

In order to obtain maximum performance and reliability from your Monoblock®, it is important that the operating temperature of the Monoblock® is kept within the recommended operating parameters. Please follow the link below for cooling recommendations.

[Monoblock® Cooling Recommendations](#)

What periodic maintenance do I need to perform for my Monoblock®?

Periodic/preventative maintenance will start with a visual inspection of the Monoblock®. The time between inspections will depend on the environmental conditions in which the Monoblock® is operating. At minimum, the Monoblock® should be inspected on a monthly basis.

MONOBLOCK[®] COOLING, SEASONING/WARM-UP and FAQ's

MONOBLOCK[®] FAQ'S (continued)

The inspection should consist of visually inspecting the control cover vents. The vents should be kept clean and clear of any debris or obstructions. For Monoblocks[®] with an integrated cooling system, the cooling fan and heat exchanger should be inspected and kept free and clear of any debris or obstructions and the hoses should be inspected for damage. The external surface of the Monoblock[®] and the X-ray exit port should be inspected for any evidence of oil. If oil is noticed the Monoblock[®] may need to be returned for service. There are no field serviceable parts in the Monoblock[®].

The Spellman High Voltage Service Department can recommend preventative maintenance for Monoblocks[®] that have been in the field for an extended period of time. For questions regarding periodic and preventative maintenance, please contact the Spellman High Voltage Service Department: service@spellmanhv.com

Is there a minimum current and voltage I can set my Monoblock[®] to? Why?

The current and voltage programming for the Monoblock[®] should not be set lower than the specified operation range stated in the unit specification. Setting the current and voltage programming below these levels may cause erroneous faults to occur. Spellman High Voltage Monoblocks[®] have a protection feature that disables the filament output (not including standby preheat current) if the voltage output is below the operating range. This is to protect the filament in the X-ray tube. Because of this feature, there will be zero tube current resulting in an under-current fault. Spellman High Voltage Monoblocks[®] have output voltage regulation fault monitoring and because of the signal-to-noise ratio in the monitoring circuits, operating below a few percent of the maximum rated output may cause a voltage regulation fault. The same situation exists for the current programming setting, which can cause the current regulation fault to trip when operating below a few percent of the rated output. Additionally, on some Monoblocks[®] the standby preheat current will cause a standby emission current that will prevent normal current regulation to occur below the specified operation range. Attempting to operate below the preheat standby emission current level will result in an overcurrent fault.

Are there any special considerations for the mechanical mounting of the Monoblock[®]?

The Monoblock[®] is designed to be used in any orientation. However, when mounting the Monoblock[®] in the system, special consideration may be required depending on how the Monoblock[®] will be supported in the system. Improper mounting of the Monoblock[®] or improper mounting of system components to the Monoblock[®] such as X-ray beam collimators may cause damage. It is recommended that you contact your sales representative or the Spellman High Voltage Service Department before installing your Monoblock[®].

How often do I need to season my Monoblock[®]? Why?

X-ray tube seasoning should be done per the recommended seasoning schedule provided with your Monoblock[®]. A general seasoning guide can be found on the Spellman High Voltage website. Typically seasoning is done after initial installation and after periods of idle time (idle time is defined as X-ray output being disabled). This would include a profile for daily seasoning and longer profiles for increased idle time. The seasoning procedure carefully raises the tube current and voltage to reduce any residual gas in the X-ray tube before the tube is operated at full output. Seasoning also minimizes un-even distribution of potential/ electric field on the tube glass. Following the recommended seasoning schedule will help prolong the life of the X-ray tube and prevent tube arcing that can potentially cause irreversible damage to the X-ray tube.

How does X-ray dose stability relate to voltage/current stability?

When trying to understand the relationship between voltage/current stability and X-ray dose stability, there are a couple of factors to consider. X-ray dose is not directly proportional to the high voltage across the X-ray tube, it is an exponential function (X^2). If the High voltage across the X-ray tube is doubled, the X-ray dose increases by a factor of four. With regards to X-ray tube current, it is directly proportional to X-ray dose.

Is it ok to keep a Monoblock[®] in storage, unused for long periods of time?

The concern with Monoblock[®] storage is with the idle time of the X-ray tube. X-ray tubes require seasoning after extended periods of off-time. It's recommended to season Monoblocks[®] in storage every 3 months. If that's not possible, longer seasoning profiles may be required and Spellman should be contacted for guidance. Generally speaking, an idle time of longer than about 6 months can be problematic and should be avoided to the extent possible. If enough idle time passes (>6 months), even the longest seasoning profiles may be inadequate for some X-ray tubes.

Will the X-ray tube last forever?

No, X-ray tubes are a consumable device and will not last forever. The amount of time it will last is due to several factors including, but not limited to: proper seasoning, cooling, X-ray hours, and X-ray tube quality. If you have an application that requires many hours of X-ray operation (X-ray ON) over the course of a year (>3000 hours), it's beneficial to let Spellman know so that your Monoblock[®] design can take this into consideration and expectations are understood.

AN-01***What do you mean; the output is "ground referenced"?***

Most of Spellman's standard catalog products are termed to be "ground referenced power supplies". A ground referenced power supply typically only has only one (1) rated high voltage output connector. Internally the high voltage multiplier return is referenced to the grounded chassis of the unit. This chassis is referenced to "house ground" in the customer's system via the safety ground wire in the power cable and a separate customer provided system ground connection. With the output of the supply ground referenced it is easy to sample the output voltage and current to obtain the feedback signals needed to regulate the supply. A high impedance, ground referenced, high voltage feedback divider monitors the output voltage, while a ground referenced current feedback resistor placed in series with the multiplier return monitors the output current.

With the customer's load being referenced to ground the circuit is complete. All measurements made with regards to the power supply utilize earth ground as the reference potential. Ground referencing a power supply simplifies its design, and fabrication. All programming and monitoring signals are also ground referenced, simplifying operation of the power supply.

Ground referenced power supplies can not in their native form be "stacked one on top of another" to obtain higher output voltages. All output circuitry is referenced to ground, preventing it from being connected to any other voltage source or reference potential.

AN-02***"Ground is ground", right? Well, not always. What you need to know.***

Ground is one of those "ideal" things like the "ideal switch" that's spoken about in engineering school. An ideal switch has all the good characteristics (no losses, zero switch time, etc) and no bad ones. The truth is, ground is only as good as you make it, and only keeps its integrity if you do the right thing.

It's much easier to start from scratch and create a good ground system than to try to fix a bad one. Grounding problems can be difficult to isolate, analyze and solve. Here are a few tips on creating a good ground system that will benefit both your high voltage power supply and the rest of your system.

A ground system starts with whatever you use as your ground reference point. There are several that can be used: cold water pipe, electrical service conduit pipe, electrical service ground wire, a building's steel girder framework, or the old fashioned ground rod. Whichever you use; connect this point to the ground stud on the HVPS with a short, heavy gauge wire and appropriate lug. Earth is the universal reference point and by tying the HVPS to it in this manner you will create a good reference point. The next important ground connection that's needed is the load return. Whatever current comes out of the HVPS (be it continuous rated current or transient arc current) must have a return path back to the power supply. This path should be an actual physical wire; again of a short, heavy type. With this connection the large transient arc currents will travel in a known path, without influencing other ground referenced equipment.

Just a point of clarification: the "3rd green ground wire" in the AC power line cord is NOT an adequate system ground. This wire is a safety ground not intended to be used as part of a grounding system. A washing machine typically has a metal chassis. If an AC power wire popped off inside and touched against the chassis you wouldn't want to open the lid and get shocked. Here, the "3rd wire" grounds the chassis, preventing a shock by bypassing the current to earth. That is its function; to be only a redundant safety ground. Don't rely on this connection as part of your system ground scheme.

Connect all additional system ground references to the main grounding point of the high voltage power supply. Be it a "star" ground system or a ground frame/plane system, attached the ground connection to the power supply main grounding point. Following these recommendations will help create a proper functioning grounding system.

AN-03***You wouldn't use a pickaxe for dental surgery: When over specifying a power supply can be a bad thing.***

Selecting the right power supply for the task at hand will reward you in several ways like: reduced size, weight, cost and superior performance. Over specifying and purchasing "more supply than you need" can actually result in degraded system performance in some circumstances.

All Spellman power supplies are designed, built and tested at their full rated output voltage and current. We have applied the appropriate component deratings for reliable long term operation at full rated voltage and current. No additional deratings of our power supplies are required.

APPLICATION NOTES—HVPS

AN-03 (continued)

If you need 30kV, buy a 30kV unit and run it at 30kV; it's what it was designed to do. The same goes for current and power. You will get the most bang for the buck buying a supply that closely fits your requirements. If you can afford a larger, heavier and more expensive supply there is nothing wrong with having a bit more capacity, but, over specifying is NOT required to get reliable operation. Minor over specifying can result in additional weight, size and cost. Gross over specifying can actually degrade system performance.

You wouldn't use a 4 inch wide exterior house paint brush to touch up delicate interior wooden trim molding. A large brush is great for quickly applying a lot of paint to a big area, but a smaller brush allows better application and control when painting smaller items. Size the tool for the intended job to get the best results.

Power supplies are similar. A 30kV supply can operate down at 250 volts, but when running at less than 1% of its rated output, it can be somewhat hard to control with great resolution. A 500 volt or even 1kV rated maximum output supply would more adequately address this requirement.

None of our supplies have any "minimum load requirements". But keep in mind if excellent low voltage or low power operation is required select a supply with maximum ratings that are close to your needs. It's easier to obtain precision operation when the power supply is properly scaled and selected for its intended usage. If not, issues like miniscule program and feedback signals, signal to noise ratios, feedback divider currents can make operating a supply at very small percentages of its maximum rated output very difficult.

AN-04

*How low can you go?
Why signal to noise ratios are important in programming high voltage power supplies.*

Virtually all Spellman power supplies are programmable; usually a 0 to 10 volt ground referenced analog programming signal is proportional to 0 to 100% of full scale rate voltage and/or current. Modular supplies typically only accept a remotely provided signal, while rack units also have front panel mounted multi-turn potentiometers to provide local programming capability.

Let's look at two example units, where 0 to 10 volts of voltage programming equates to 0 to 100% of output voltage. The first unit is an SL100P300 (100kV maximum) and the second unit is an SL1P300 (1kV maximum).

If a rather low output voltage of 100 volts was desired, let's look at the level of programming voltage each unit requires.

SL100P300	SL1P300
(100/100,000) (10) = 10mV	(100/1000) (10) = 1 volt

The SL100P300 needs a programming signal of 10mV, while the SL1P300 needs a programming signal of 1 volt to achieve the same 100 volt output.

Noise is present in most electrical systems; it's the low level background signal that is due to switching regulators, clock circuits and the like. Ideally zero noise would be desired, but some amount is present and must be dealt with. In a power supply like the SL Series 25mV of background noise on the analog control lines is not uncommon. Ideally we would like to have the programming signal as large as possible, so the noise signal has the least amount of influence. Let's see how that noise affects the signals of our two example power supplies.

SL100P300	SL1P300
Signal = 10mV	Signal = 1000mV (1 volt)
Noise = 25mV	Noise = 25mV
s/n ratio: signal is smaller than noise	s/n ratio: signal is 40X larger than noise

It's easy to see that getting a stable, repeatable 100 volt output from the SL100P300 will be quite difficult, while this is easy to do with the SL1P300.

When low output voltages are needed think about the programming signals required and how they compare to the system noise levels. Doing so will provide a stable, repeatable output where noise has minimal effect.

AN-05

"No, you touch it". HVPS output fall and discharge times explained.

When working with high voltage power supplies knowing about output fall and discharge times can be helpful. Consider this information as only providing additional details on power supply functionality. This application note by itself is not adequate "safety training" for the proper setup and use of a HVPS. Please refer to the complete safety information provided with our products.

APPLICATION NOTES—HVPS

AN-05 (continued)

Typically, high voltage is created by controlling an inverter that feeds a step up transformer which is connected to a voltage multiplier circuit. This multiplier circuit (an arrangement of capacitors and diodes) uses the principle of charging and discharging capacitors on alternate half cycles of the AC voltage, where the output is the sum of these capacitor voltages in series. By definition, the voltage multiplier circuit is capacitive in nature and has the ability to store and hold charge.

For the sake of efficiency, any internal current paths to ground are minimized. Typically the only resistive path connecting the output of the supply to ground is the high impedance voltage feedback divider string. This feedback divider generates the low level, ground referenced, voltage feedback signal used to control and regulate the supply.

Due to the orientation of the diodes in the multiplier assembly, a positive polarity supply can only source current; it has no ability to sink current. So the feedback divider string becomes the only discharge path for the output during a "no-load" condition. Let's look at a typical unit's value of multiplier capacitance and feedback divider resistance to see what kind of no load RC discharge time constants we're talking about.

SL60P3000

60kV, 0- 5mA, 300 watts

C multiplier = 2285pF R feedback = 1400MΩ

RC = (2285pF) (1400MΩ) = 3.199 seconds

5 RC time constants required to approach zero (≈1.2%)

(5) (3.199 seconds) = 15.995 seconds

The above example illustrates how under a no load condition it can take considerable time for the output to discharge. If an external load is left connected to the supply's output, the discharge time constant can be shortened considerably. For this reason HVPS fall times are termed to be "load dependent". Keep this in mind when working with your next HVPS.

AN-06

***"Just jumper the external interlock"?
Why you really shouldn't.***

Many Spellman high voltage power supplies come with an external interlock feature. Typically the external interlock is provided by means of two signal connections on the rear panel terminal block or interface connector. This feature provides the user the ability to shut off and prevent the generation of high voltage in a fail safe manner. This external interlock circuitry can easily be incorporated into the user's setup to provide an additional level of operator safety.

In most cases the current of the relay coil that is used to latch the power supply into the HV ON mode is routed out to, and back from, the rear panel external interlock points. This is usually a low voltage relay coil; 12Vdc or 24Vdc with current in the range of tens of milliamps. The two external interlock points must be connected together with a low impedance connection to allow the power supply to be placed into, (and to continue to operate in) the HV ON mode.

Opening this connection will prevent the supply from being placed in the HV ON mode. Additionally, if the unit was actively running in the HV ON mode, open this connection would cause the power supply to revert to the HV OFF mode. The external interlock is the best method of controlling the power supply output with regards to safety, other than disconnecting the power supply from its input power source.

Typically our power supplies are shipped with the two external interlock connections jumpered together to allow quick and easy operation of the supply. Leaving the unit configured in this manner does indeed work, but it bypasses the external interlock function.

Spellman recommends that any exposed high voltage potential be isolated from contact through the use of appropriate physical barriers. High voltage cages or enclosures should be used to protect operators from inadvertent contact with potentially lethal voltages. Doors and/or access panels of these cages or enclosures should have a normally open interlock switch installed on them such that the switch is in the closed state only when the door or panel is in the secured position. Opening the door or panel will revert the power supply to the HV OFF mode, and prevent the supply from being placed in the HV ON mode until the door or panel is properly secured.

APPLICATION NOTES—HVPS

AN-07

What's the voltage rating of RG8-U coaxial cable?

Output cable and connectors are not trivial items for power supplies where output voltages can be 100,000 volts or higher. The cables and connectors used must function together as a system to safely and reliably access and provide the power supplies output for customer usage.

In many high voltage power supply applications, a shielded polyethylene coaxial cable is used. Polyethylene cables provide excellent high voltage dielectric isolation characteristics in a small but robust form factor. The shield conductor provided in a coaxial cable functions as a "Faraday Shield" for the center conductor of the cable that is referenced to the high voltage potential. If any breakdown in the main insulator occurs, the high voltage current will be bypassed to the grounded shield conductor that surrounds the main insulator. This inherent safety feature is one benefit of using a coaxial high voltage output cable.

RG8-U has long been used as a high voltage output cable in the high voltage industry. There is a variation of RG8-U that utilizes a solid polyethylene core. Specifications for this cable do not specify actual "high voltage" ratings, since this cable was not designed and fabricated with high voltage usage in mind. So the reality is, there are no high voltage ratings for RG8-U. Over the years others in the HV industry have used this cable at 20kV, 30kV and even higher voltages. Spellman does use RG8-U cable, but limits its usage to applications where the maximum voltage that will be applied to the cable is 15kV or less.

For voltages above 15kV where a coaxial polyethylene cable is desired, Spellman uses cables specifically designed and manufactured for high voltage usage.

These cables are of the same general design; as described above but the insulating core material diameter has been increased appropriately to obtain the desired dielectric insulating capability required. Frequently higher voltage versions of these cables utilize a thin semiconductor "corona shield". This corona shield is located between the metallic center conductor and the main polyethylene insulating core. This corona shield helps equalize the geometric voltage gradients of the conductor and by doing so reduces the generation of corona.

A high voltage cable and connector system can only be as good as the materials used to make it. Using cables that are designed, specified and tested specifically for high voltage usage assures that these materials are used within their design guidelines.

AN-08

How do I change the polarity of the power supply?

How do I change the polarity of the power supply? Most high voltage power supplies use a circuit called a voltage multiplier to create the desired high voltage output. This basic multiplier circuit is shown below in the simplified power supply block diagram:

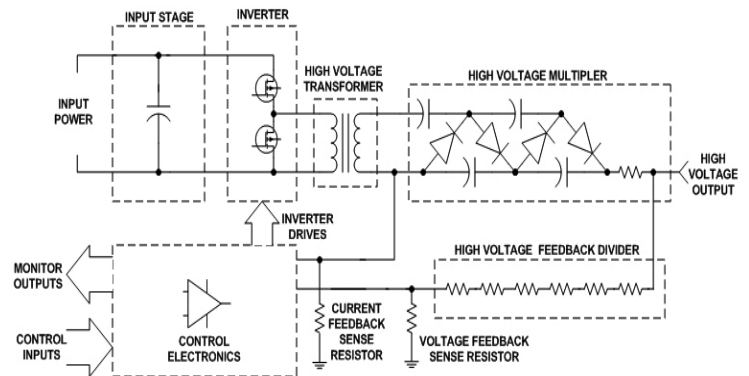

Simplified Schematic Diagram of a High Voltage Power Supply

The multiplier circuit is comprised of an arrangement of capacitors and diodes. The orientation of the diodes will determine the output polarity of the unit. In the example above, the diodes shown would create a positive output polarity with respect to ground. If each diode was reversed in orientation, the multiplier would generate a negative output voltage with respect to ground.

The example above only shows a two stage, half-wave multiplier; using a total of four diodes. Full-wave multiplier stages are more efficient and use additional capacitors and twice as many diodes. To generate the high voltages typical of a Spellman supply, many multiplier stages are connected in series. If a twelve stage, full wave multiplier was made, a total of 48 diodes would be required.

Typically the capacitors and diodes used to fabricate a multiplier assembly are soldered directly to a single or sometimes several printed circuit boards. Frequently this assembly is encapsulated for high voltage isolation purposes.

To simplify the process of reversing the polarity (like in the instance of the SL Series) a second "opposite polarity" multiplier is provided above 8kV when reversibility is required. Exchanging the multiplier is a simple task needing only a screwdriver and few minutes of time. Modular style units due to their simplified design, are typically not capable of having their polarity changed in the field.

AN-09

Why do power supplies take time to warm up?

Power supplies typically have a warm up period, after which stability specifications are then applicable. From a functionality standpoint, a unit will work the moment after it's turned on. But if your application requires a very stable output, allowing the power supply to warm up and reach "thermal equilibrium" will eliminate the warm up drift, which is detailed as follows:

Control and regulation of the power supply is accomplished by sampling the actual high voltage output through the use of a high voltage feedback divider. This divider network is comprised of a number of series connected high impedance, high voltage resistors. One end of the divider is connected to the power supply's high voltage output; while the other end is terminated to ground through a scaling resistor creating a low voltage signal that is proportional to the high voltage output being measured. Typically a 0-10Vdc feedback signal is created, which corresponds to 0-100% of the power supply's output voltage.

The feedback divider string is sensitive to temperature variations. This is called the "temperature coefficient" (TC) and it is usually specified in parts per million per degree C. A typical temperature coefficient spec might be 150ppm/°C. For this case the resistor impedance value will change by the ratio of $(150/1,000,000) = 0.00015$, or 0.015% for each degree C of temperature change the feedback divider sees.

Let's look at a real life power supply example:

$$\text{SL50P300 TC} = 100\text{ppm}/^\circ\text{C} \ (100/1,000,000) = 0.0001 \ \text{or} \ 0.01\% \ (0.01\%) \ (50\text{kV}) = 5 \ \text{volts}$$

So for each degree C change the feedback divider sees, the proportional change in the power supplies output voltage shall be ≤ 5 volts.

If a power supply has been sitting unused for a long period of time we can assume the components inside the supply are at the ambient room temperature. For the purpose of illustration let's say the room temperature is 22°C (about 71.5°F) and we will assume the room temperature remains constant for the duration of our test.

The power supply is turned on and set to operate at maximum voltage and current. There are two basic effects that occur:

- 1.) The feedback divider begins to create its own self heating effect due the I²R losses of the feedback current flowing through the feedback resistors.
- 2.) There are other components in power supply that also generate heat, and this begins to raise the temperature inside the power supply itself, which in turn raises the temperature of the feedback divider string.

After an amply long period of time, the power supply reaches a new thermal equilibrium. For the sake of this example let's say the temperature of the feedback divider string is now 28°C (about 82.5°F), a change of 6°C.

We know that the feedback divider is specified to change $\leq 0.01\%$ (or ≤ 5 volts) for each degree C change in our example. So the overall change we would expect would be: $(5 \ \text{volts}/^\circ\text{C}) \ (6^\circ\text{C}) = \leq 30 \ \text{volts}$

Overall this is a small percentage compared to the magnitude of the maximum output voltage, but in some critical applications it could be significant.

What about the time period it takes for this change to occur?

Well that's mostly influenced by the actual physical design of the power supply itself. The thermal mass content of the unit, the internal heat transfer characteristics, air flow in and out of the enclosure, and the design of multiplier in particular will greatly influence the thermal time constants involved.

APPLICATION NOTES—HVPS

AN-10

Fixed polarity, reversible polarity, four quadrant operation...a simple explanation.

Most of the products Spellman manufactures and sells are DC high voltage power supplies. DC power supplies have some fundamental limitations as to their operational capability. To understand what a typical DC high voltage power supply can do with respect to output voltage, current and power convention it is helpful to use a Cartesian coordinate system as shown in the figure below.

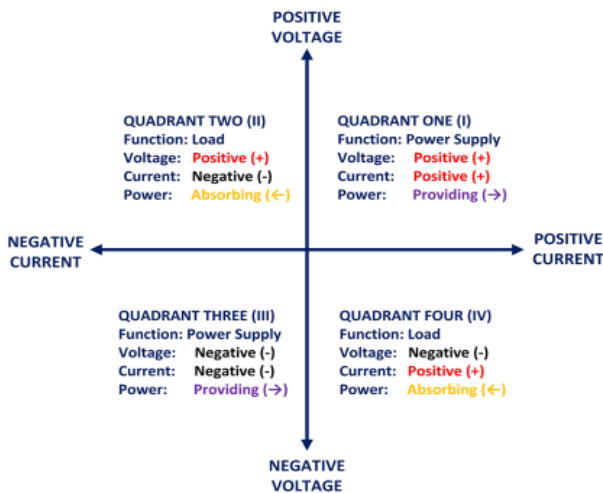

Output current and voltage are shown on the respective horizontal and vertical axis and four operational quadrants are created.

Quadrants One and Three are the characteristic operating parameters of a power supply where power is being provided to the output. Quadrant One identifies a positive output polarity power supply whereas quadrant Three identifies a negative polarity output power supply.

Quadrants Two and Four are the characteristic operating parameters of a load where power is being absorbed from the output. This realm is typically not a functional capability of Spellman’s standard DC high voltage power supplies.

Many of Spellman’s power supplies do have the ability to reverse their output polarity; typically either a wiring change or a complete exchange of the high voltage output section is required. Due to this fact our units cannot smoothly and seamlessly control through zero and cross back and forth easily between quadrants One and Three. Even units like our CZE Series that have complete and distinct positive and negative output sections that use a high voltage relay to change output polarity still require the output voltage to fully decay to zero before a polarity change can be implemented.

AN-11

High voltage power supply dynamic load characteristics

Spellman’s high frequency switching power supplies have minimal output capacitance, inherent by design. Dynamic load changes can quickly discharge output capacitance, causing the output voltage to drop out of static regulation specification. Even if the load step draws current that is within the rated current of the power supply, there may be some “droop” in the output voltage. This droop is sensed by the voltage feedback divider, which in turn causes the voltage loop to command the power supply to increase the output voltage to bring the unit back within static voltage regulation specification. None of this happens instantly, it all take time to accomplish. Typically recovery times for Spellman’s power supplies (when specified and measured) are in the order of individual to tens of milliseconds.

The amount of droop is mostly influenced by the following parameters:

- 1.) Capacitance of the power supply’s output section and any external, stray or load capacitance
- 2.) Magnitude of load current being drawn from the supply
- 3.) Duration of load step event

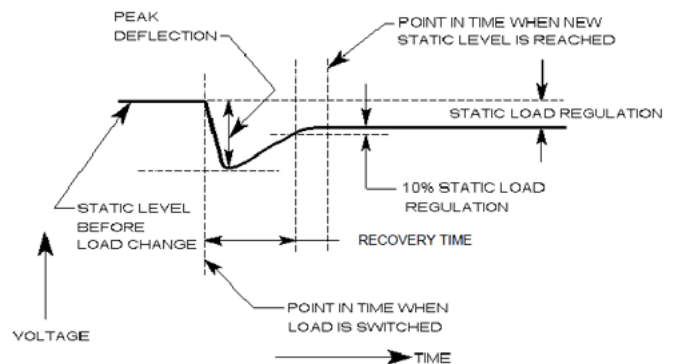

The voltage recovery waveform time period and overall shape (under damped, over damped or critically damped) are dependent upon the parameters outlined above in addition to the compensation characteristics of both the voltage and current loops of the power supply.

Power Supply Response

Loop compensation values are selected for a variety of performance related specifications like: dynamic recovery, ripple rejection, and overall power supply stability margins. These are all interrelated characteristics and changing loop compensation values to improve one category of performance can adversely affect another. Spellman

AN-11 (continued)

generally stresses overall power supply stability and ripple performance when selecting loop compensation values for our standard power supplies, as typically there are no dynamic performance specifications listed. If specific dynamic load recovery characteristics are required, then that unique unit must be built with testing performed in Engineering to establish baseline specifications as a starting point as what may be able to be accomplished on a custom basis.

When customers do inquire about dynamic load recovery specifications it is important we understand the exact nature of the application. Additionally we need to understand just how the dynamic load response is being measured and specified. Typically a 10% to 90% voltage recovery time is specified, along with a percentage of maximum rated voltage overshoot allowable. Other methods are acceptable as long as both Spellman and the customer are consistent in how things are measured and specified.

Making these types of dynamic load response measurements can require specialized test equipment; like dynamic load fixtures that can electronically pulse the load on and off so the voltage recovery response waveforms can be obtained. Depending upon what the power supply's output voltage, current and power capability is, fabricating this type of dynamic load test fixture can range from inexpensive and reasonable in difficulty; to prohibitively expensive and a very complex Engineering task.

If you have specific power supply dynamic load response requirements please provide these needs in your initial inquiry, understanding our standard catalog products have no advertised dynamic performance specifications. Spellman's Engineering team will evaluate your requirements and advise what kind of hardware solution we may be able to provide.

AN-12***The benefit of using a current source to power X-Ray tube filament circuits***

Virtually all the filament power supplies Spellman uses in their X-Ray generators and Monoblock[®] X-Ray sources are current sources...not voltage sources. That is, the filament power supply controls and regulates the current through the filament of the X-Ray tube. This is done to protect the filament and obtain the longest usage and lifetime of the X-Ray tube possible.

If a voltage source is used to power a filament then the current through the filament is dependent upon the impedance of the circuit. Cold filaments have a low impedance, as they heat up the impedance rises. So if you drive a filament with a voltage source you typically get a large spike of current at turn on...this is why most household incandescent light bulbs usually fail (blow out) at initial turn on.

With a current source filament power supply the current through the filament is always regulated, regardless of the impedance of the load. In fact, even if a short circuit was placed on the output, the current would still be regulated and limited to a safe level.

In this current regulated scenario "voltage" is not a critical factor. The voltage is nothing more than the compliance of the circuit. Whatever the impedance of the circuit is (filament resistance, cable and connector resistance, etc.), this times the current flowing through the circuit will yield a voltage. As long as the current source filament power supply has more compliance voltage capability than the total circuit needs, all is fine.

The only time the "voltage limit circuit" could ever come into effect is if there is an open filament fault. In this case it's basically a moot point, the filament is open... you can't make X-Rays and the X-Ray tube requires replacement. Does it really matter if the open filament cable has 6 volts across it or 12 volts across it? No it doesn't, the filament is open, and the X-Ray tube can't function because you have an open filament circuit.

For this reason we don't fuss much with voltage limit settings on filament power supplies. As long as there is enough compliance voltage to drive the effective filament load...all is fine. If the filament fails, the maximum open circuit sourcing voltage will be limited to a safe and predictable level. With a current source filament power supply playing with the setting of the voltage limit circuit provides no real additional protection or benefit for the X-Ray tube.

APPLICATION NOTES—HVPS

AN-13

Arc intervention circuitry and external series limiting resistors

Spellman's power supplies that have arc intervention features sense arc currents via a fast acting current sense transformer in the low end return of the multiplier circuitry. This circuitry converts the actual measured short circuit discharge current to a proportional voltage signal and then level sensing is done to determine when an arc has occurred.

Discrimination must be performed to prevent typical multiplier charging currents from setting off the arc detection circuitry which could prevent normal operation. The purpose of the arc intervention circuitry is to prevent damage to the power supplies output limiting resistors due to continuous, long term arcing. Our arc detection circuitry is not a sophisticated, precision circuit; nor is it designed or intended to sense every possible arcing event.

Series limiting resistors in the multiplier assembly limit short circuit discharge currents to safe and predictable levels. Knowing what these levels are the trip point for the arc detection circuitry can be set by Spellman that will protect the power supply from excessive arcing, while allowing normal power supply functionality.

If a customer provides a large external limiting resistor placed in series with the power supply output it may effectively render the arc intervention circuitry unable to detect an arc. This is due to the fact that short circuit discharge currents may be dramatically reduced below the detection threshold due to the external limiting resistor.

From the power supplies standpoint this is typically a beneficial situation as it reduces the stress on our internal short circuit limiting resistors, the very thing we are trying to protect with the arc intervention circuitry. Short circuit discharge currents are lowered, power dissipation in the internal output limiters are reduced... customer provided external short circuit limiting is typically a good thing from the power supplies perspective.

There are some unique conditions where the continuous arc discharge rate required for a particular application far exceeds the capability of the high voltage power supplies design. In these situations a customer provided external limiting resistor may be a viable solution to this problem. Spellman can even configure a custom supply to regulate on the "far side" or output node of the customer provided external limiting resistor, effectively canceling out any voltage drop.

If your application requires unique arc intervention capability beyond the ability of a standard unit, please discuss your requirements with Spellman to see what hardware solutions we can provide.

AN-14

The limits of front panel digital meters

Most of Spellman's rack mounted high voltage power supplies and X-Ray generators have full feature front panels complete with digital meters to display output voltage and current. These meters are intended to be used as a non-precision reference of the functional state of the power supply. Because of inherent limitations as described below, it is not recommended to use the front panel meters as a means of obtaining precision process control, especially for small signal readings.

Digital Meter Voltage Maximum Input Requirements

The series of digital meters employed utilize a 0-2Vdc input voltage signal. 2Vdc is the absolute maximum input signal the meter can accept. Spellman uses a 0-10Vdc programming signal for programming and monitoring of the high voltage power supply. This means the 0-10Vdc voltage and current monitor signals generated power supply feedback circuitry must be divided down to 2Vdc or less in order to be displayed on the front panel meters. Dividing down a signal brings it closer to background noise, reducing the signal to noise ratio.

Signal Attenuation

A 30kV power supply would have a 10Vdc full scale voltage monitor signal provided on the rear panel interface connector. But to get the front panel digital meter to read properly, this 10Vdc signal must be attenuated to 300mV. Yes 300mV, because 10Vdc would not display the proper numbers on the digital meter, and dividing the 10Vdc signal to 3Vdc is still too large for the meters 2Vdc maximum input.

AN-14 (continued)**Signal to Noise Ratios**

Noise is present in most electrical systems. It's the low level background signal that is due to switching regulators, clock circuits and the like. Ideally zero noise would be desired, but some amount is present and must be dealt with. In switching power supplies, 25mV's of background noise on the analog control lines is not uncommon. Typically it is desirable to have the signal as large as possible when compared to the noise providing the highest signal to noise ratio.

Example

With the 10Vdc full scale rear panel voltage monitor:
 $10V/25mV = 400$, the signal is 400 times the noise

With the 300mV full scale front panel digital meter:
 $300mV/25mV = 12$, the signal is 12 times the noise

Once the power supply is operated at less than maximum output voltage, the signal to noise ratio condition only worsens. Trying to obtain accurate, repeatable results at very small percentages of maximum rated output can be difficult to downright impossible in some instances.

Meter Accuracy

The series of front panel meters used have a typical accuracy of 2%, ± 1 least significant bit. They refresh the display at the rate of about 2 times per second. These specifications are fine for use for informal reference metering, but they should not be considered precision measurement equipment.

Summary

Because of the mentioned issues with small signal levels, signal to noise ratios and the non-precision nature of the front panel meters themselves, relying on these meters to make critical process control measurements is not recommended. The use of the power supply's full scale 0-10Vdc rear panel monitor signals coupled with an external, high precision, 5.5 or 6.5 digit meter will provide the best option in the measurement of the power supplies performance.

AN-15**3.5 and 4.5 digit meter displays explained****Full Digit**

Digital meters are typically described as having "half digit" capability. A full digit is a display segment that can render all the numbers from 0-9, that is 0, 1, 2, 3, 4, 5, 6, 7, 8, and 9.

Half Digit

A half digit can display only the number 1. The half digit is always the first digit shown. Because the half digit is basically only a "1" it has limited possible use.

Decimal Point

The decimal point is just a "dot" segment that is manually displayed after the appropriate number segment to show the proper complete number desired. A dot can be displayed after any desired number, typically via a jumper setting. If the jumper is not installed, no dots at all will be displayed.

3.5 Digit Display Example

A 3.5 digit display is actually four segments, one half digit and 3 full digits. Displaying maximum capability it would read 1999. If we wanted to display 30kV on a 3.5 digit meter we would have to "throw out" the leading half digit as we can't make use of it because it's only a "1". We are limited to using the three full digits, so the display would be 300. The decimal point is manually placed via a jumper, so the final display would be 30.0 and the "kV" term would be screened on the front panel overlay. If we wanted to display 10kV on a 3.5 digit meter we can make use of the leading half digit. In this case we would have four digits of resolution with the meter displaying 1000. Placing the decimal point properly, the final meter reading would be 10.00 with the "kV" term screened on the front panel overlay.

4.5 Digit Display Example

If the DPM4 option is ordered, the standard 3.5 digit meters are upgraded with 4.5 digit meters. A 4.5 digit display is actually five segments, one half digit and 4 full digits. Displaying maximum capability it would read 19999.

Using the examples above, if we wanted to display 30kV on a 4.5 digit meter we would have to "throw out" the leading half digit as we can't make use of it because it's only a "1". We are limited to using the four full digits so the display would be 3000. The decimal point is manually placed via a jumper, so the final display would be 30.00 and the "kV" term would be screened on the front panel overlay.

APPLICATION NOTES—HVPS

AN-15 (continued)

If we wanted to display 10kV on a 4.5 digit meter we can make use of the leading half digit. In this case we would have five digits of resolution with the meter displaying 10000. Placing the decimal point properly the final meter reading would be 10.000 with the “kV” term screened on the front panel overlay.

2, 20, 200, 2000 – A Unique Situation

Due to the 2Vdc maximum input requirement of the digital meter used, there's a unique situation that occurs for, let's say, a 20kV unit. You could take the 10Vdc full scale signal and divide it down to 200mV and you would get...

20.0kV a maximum of 3 digits of resolution. But there's a way to "sneak" another digit of resolution out of a 20kV unit.

If you divide the 10Vdc full scale voltage monitor signal down to 2Vdc then for the vast majority of the display range you will get four digits of resolution or 19.99kV as a maximum display. The only drawback is when the unit is programmed to over 19.99kV the meter will “overscale” and display the leading "1" digit but all the following digits will be blank. There is nothing wrong with this condition; it is just what happens when more than a 2Vdc signal is inputted into the front panel digital meter.

AN-16**Parallel capability of the ST Series**

The Standard ST unit is a single, 6U tall, 12kW rated high voltage power supply. When higher power levels are required, the ST Series is designed to offer additional power capability by adding chassis in parallel to create a Primary/Secondary configuration providing up to and beyond 100kW's of high voltage output power.

The Primary chassis is the point of connection for customer interfacing; this multi chassis system effectively functions as a single power supply. The Primary unit retains the full featured front panel, while Secondary unit(s) have a Blank Front Panel.

This factory configured Primary/Secondary arrangement is required because multiple independent voltage sources cannot be connected in parallel. As such there are three fundamental types of ST units due to their specific functionality:

Standard

The standard ST unit is the single, 6U tall, 12kW rated chassis as detailed in the ST data sheet. This single chassis unit has a full feature front panel, has no ability to function in a parallel capability and is limited to 12kW's of output power.

Primary

A Primary unit outwardly appears to be very similar to a Standard unit, but is quite different as it is configured (hardware and firmware) to function as the controlling entity of a Primary/Secondary arrangement. The Primary chassis must be factory setup and tested to control a particular known arrangement of Secondary units. A Primary unit is designed to operate with the full complement of Secondary units as per the original factory configuration. It is possible to operate the Primary unit with less than the full number of Secondary units or even by itself but power capability, programming and feedback scale factors will be affected.

Secondary

A Secondary unit can usually be recognized due to its blank front design. A Secondary unit cannot function by itself as it is factory hardware and firmware setup to operate as part of a preconfigured Primary/Secondary system.

AN-17**High voltage power supply programming resolution explained**

Most high voltage power supplies manufactured by Spellman are programmable, that is the user can set the output typically anywhere from zero to 100% of rated output voltage (or current). This is usually accomplished via one of the following means:

- *Local Front Panel Control*
- *Remote Control – Analog Signal*
- *Remote Control – Digital Signal*

Local Front Panel Control

Local control refers to the use of an onboard potentiometer(s) to program the output voltage/current. Some modules have customer accessible potentiometers (MPS, PCM, SLM, etc.) that allow the user to program the voltage/current. Most of Spellman's rack mount units have a full feature front panel where locking counting dials are provided to set desired the voltage/current.

So if the power supply control circuitry is analog in nature and the front panel potentiometer(s) are used to program the power supply, the potentiometer(s) determines the programming resolution obtained.

Cermet (ceramic/metal) or plastic film potentiometers the wiper can be set closer to the desired value since the resistive element presents a continuous contact surface, as opposed to discrete turns of a wire as in a wire wound potentiometer which yields a fundamental resolution limitation. Most modular power supplies that have local programming capabilities employ cermet or plastic film potentiometers, so these units could technically have

APPLICATION NOTES—HVPS

AN-17 (continued)

“near infinite resolution” as specified by the manufacturer. The potentiometer used on most rack units is a wire wound Bourns 3590 5kΩ, 10 turn potentiometer which has a resolution specification of 0.025%.

If the module or rack power supply has a standard digital interface (RS-232, Ethernet or USB) the power supply control circuitry is digital in nature. Even if a front panel generated analog signal is used to control the power supply, this signal will be digitized at the bit resolution employed by the digital interface and control circuitry.

Remote Control – Analog Signal

If the power supply control circuitry is analog in nature and a remotely generated analog signal is used to program the power supply, this customer generated analog signal will determine the programming resolution obtained.

If the module or rack power supply has a standard digital interface (RS-232, Ethernet or USB) the power supply control circuitry is digital in nature. Even if an analog signal is provided to the power supply, this signal will be digitized at the bit resolution employed by the digital interface and control circuitry. So the resolution limitation could be either the customer generated analog signal or the bit resolution of the power supply, whichever is greater.

Remote Control – Digital Signal

If the module or rack power supply has a standard digital interface (RS-232, Ethernet or USB) the power supply control circuitry is digital in nature. Programming the power supply via one of the digital interfaces will result in a resolution limited by the bit resolution employed in the digital circuitry and control circuitry of the power supply.

AN-18**Current loop/arc detection circuitry****Current Feedback/Current Loop**

The current feedback and current control loop have absolutely nothing to do with the way Spellman’s power supplies detect an arc. Overcurrent is a long term, low impedance fault condition that may persist for an extended period of time. The power supply sense this via its current feedback and crosses over from constant voltage mode to constant current mode to regulate the continuous DC current to the level as per the current programming input signal. The time constants associated with the current feedback circuit and current error amplifier usually take milliseconds or tens of milliseconds to occur so we do not use the current feedback to determine if an arc has occurred. Current feedback is only used to regulate long term DC current as per the current loop.

Arc Characteristics

Arcs are characterized by a very low impedance that can happen very, very quickly and may exist for only microseconds, tens or hundreds of microseconds. When this situation occurs this is basically a capacitive discharge event as far as the power supply is concerned. We have a charged capacitor (the power supplies internal multiplier capacitance) and a very low impedance connection placed upon the output of the supply. The only thing that will limit the current that flows is our internal series limiting assembly (typically resistors and/or inductors). Without some kind of limiting employed technically infinite current would flow during the arc. But our internal limiting resistors limit the current to a safe discharge level. A high voltage power supply that is rated to put out milliamperes continuously may have amps or even tens of amps flowing during that short arc discharge event. This is NOT the normal rated power supply current, it is capacitive arc discharge current...they are two very different things.

Current Sense Transformer

Due to the fast time frames and the huge currents that flow during an arc Spellman uses a different means of sensing arc events... a current sense transformer. A current sense transformer is connected to the bottom end of the multiplier circuitry. The normal low level DC current the power supply is rated for is not seen by the current sense transformer. When an arc occurs in microsecond time frames with huge current levels...that is seen by the current sense transformer. We use this to determine an arc has occurred.

Arc Intervention Process

We need to go through an arc intervention process because whatever energy is stored in our multiplier capacitance is dissipated as heat in our output limiting assembly. Individual arcing will not damage the power supply, but repetitive long term arcing can overheat the output limiting circuitry. The power supply has a finite amount of arcing it can tolerate in a given amount of time before overheating damage occurs. Our arc intervention process prevents any damage from occurring. There is no ability to change or modify WHAT we call an arc; Spellman determines what is sensitive enough to protect the power supply, while not being too sensitive that would prevent normal operation.

What Our Arc Circuitry Is Not

Spellman’s arc sense and arc intervention process is there to protect the power supply from excessive long term arcing; it is not a precision, infinitely adjustable, circuit for customers to play with. If precision, adjustable arc detection is required by the customer, Spellman recommends that this be done via an external current sense transformer implemented by the customer. This way the required arc protection the power supply needs remains intact, and the customer can configure their external arc sense transformer to behave in any way they see fit.

AN-19

Keep it short if you can. High voltage cable lengths discussed.

Most of Spellman's high voltage power supplies use some type of cable to connect the output of the high voltage power supply to the customers "load". Many of these cables are coaxial in nature. The coaxial cable has inherent safety protection due to its grounded shield, in addition to noise suppression and a good ground path from source to load.

But coaxial cable adds capacitance to the output. Depending upon the specific type of coaxial cable used the capacitance could be 30pF or more of capacitance per foot of high voltage cable length. At the extreme high voltages Spellman's power supplies operate at, even a nominal amount of capacitance can have a significant amount of stored energy. Energy stored in a capacitor is calculated as:

Stored Energy (Joules) = $\frac{1}{2} CV^2$, where C is the capacitance and V is the applied voltage.

It is easy to see how even a small amount of capacitance can have a large amount of stored energy at high voltage, as the voltage term is squared. There are instances where the high voltage cable can have more stored energy than the output capacitance of the power supply.

This cable capacitance is seen as external capacitance to the power supply. The power supply must charge and drive this capacitance, and under certain cases this can present problems. But the real issue is what happens when arcing occurs. Due to the location of this cable capacitance there is no resistor in series with this energy source dissipating the stored energy. The power supply has arc limiting resistors built into its output to limit the power supplies arc current discharge magnitude to safe and predictable levels. Cable capacitance has no such limiting so during arcing the discharge currents can be huge and the energy can cause voltage cycling; "ringing" which can be very damaging to the cable and the power supply. Eventually the energy will be dissipated by the arc impedance and other dissipative elements, but only after very high voltage ringing has occurred. This can also be detrimental to delicate customer loads and wreak havoc with improperly grounded equipment.

For these reasons it's considered good engineering practice to try to keep the length of the high voltage cables as short as possible. Does this mean you can't have a power supply with a long cable? No. But with all things being equal a setup with a short high voltage cable is likely to be less problematic than the same setup with a very long high voltage cable.

AN-20

Grounding for high frequency transients due to arcing events

Single point grounding schemes are often touted as the best means of grounding an electrical system. Drawn out on a piece of paper, maybe somewhat simplified to represent your complex setup, single point ground systems seem like the logical choice. The real world fact is frequently single point grounding is not feasible to implement due to various real world constraints.

Additionally the truth is single point grounding doesn't work at higher frequencies (i.e., high frequency transients at occur during arcing), where path inductance and standing waves can cause voltage drops. Additionally stray capacitance that the system designer may have no control over, can create alternate paths that can be difficult to account for.

So a functional single point grounding system may be impossible to implement but you still need to execute a grounding scheme, what do you do? Well providing low impedance ground paths is the desirable method to address issues due to high frequency high voltage arc discharges.

How do you do this in the real world? Ground everything as often as possible. Yes, multiple ground connections. But what about ground loops, you ask? In a nutshell, don't worry about ground loops. Once there is more than one ground it's a multiple ground point system and the only practical solution is to make the impedance of the system as low as possible.

This can be done by using wide structural metal members, sheet metal when possible and bolting them together at frequent intervals. If a metal chassis can't be used then the only route left is using cables. This method has its drawbacks as grounding wires, cables and straps can be too inductive above audio frequencies.

So don't get stuck trying to execute and troubleshoot a questionable "ideal" grounding topology, implement what is possible and proven to work in the real world.

APPLICATION NOTES—HVPS

AN-21

How to calculate maximum AC input current

Knowing a power supplies maximum input current can be helpful in selecting electrical service requirements, circuit breaker selection, AC input cable and connector selection and even picking an isolation transformer in floating applications. Calculating the maximum input current is fairly easy knowing a few basic parameters and some simple math.

High Voltage Power Supply Power Rating

All of Spellman's power supplies have an advertised maximum power rating, in watts. This is the first parameter we'll need and it can be obtained from the product data sheet. Most of Spellman's power supplies have the maximum power rating right in the model number. Like for this example an SL30P300/115 is a 30kV, positive polarity unit that can provide 300 watts, maximum; operated from 115Vac input line.

Power Supply Efficiency

The power supplies efficiency is the ratio of input power to output power. Efficiency is typically stated as a percentage or a decimal less than 1, like 80% or 0.8. To figure out the input power we take the stated maximum output power and divide by the efficiency:

$$300 \text{ watts} / 0.8 = 375 \text{ watts}$$

Power Factor

Power factor is the ratio of the real power to apparent power utilized. It is typically expressed as a decimal number less than 1. Real power is expressed in watts while apparent power is expressed in VA (volt-amperes). Single phase uncorrected switching power supplies typically have fairly poor power factor, like 0.65. Three phase uncorrected switching power supplies have a higher power factor, like 0.85. Units with active power factor correction circuitry can have very good power factor like 0.98. In our example above the supply is an uncorrected unit, powered by a single phase line so:

$$375 \text{ watts} / 0.65 = 577 \text{ VA}$$

Input Line Voltage

We need to know the AC input voltage the unit is designed to be powered from. In the example above the AC input voltage is 115Vac. This is the nominal voltage, in reality the input voltage is specified at $\pm 10\%$. We need to subtract 10% to account for the worst case, low line condition:

$$115\text{Vac} - 10\% = 103.5\text{Vac}$$

Maximum AC Input Current

If we take the 577 VA and divide it by 103.5Vac we get:

$$577 \text{ VA} / 103.5\text{Vac} = 5.57 \text{ amps}$$

If our AC input voltage is single phase, then we have our answer, 5.57 amps.

Three Phase Input Voltage

All Units with three phase input voltage are powered by three phases, hence they have a better power factor number than single phase units. Also due to the presence of three phases powering the unit, phase currents will be less. To obtain the input current per phase we divide our input current calculation by $\sqrt{3}$ (1.73).

Let's calculate this example: STR10N6/208. From the STR data sheet we find out the maximum power is 6000 watts, the efficiency is 90% and the power factor is 0.85. Although the STR will operate down to 180Vac by design, in this example it will be powered via 208Vac, 3 phase. We obtain the maximum input current per phase as follows:

Power Supply Efficiency

$$6000 \text{ watts} / .9 = 6666 \text{ watts}$$

Power Factor

$$6666 \text{ watts} / .85 = 7843 \text{ VA}$$

Input Line Voltage

$$208\text{Vac} - 10\% = 187\text{Vac}$$

Maximum AC Input Current

$$7843 \text{ VA} / 187\text{Vac} = 41.94 \text{ amps}$$

(if it was single phase)

Correction for Three Phase Input

$$41.94 \text{ amps} / \sqrt{3} (1.73) = 24.21 \text{ amps per phase}$$

So we have two equations, one for single phase inputs and one for three phase inputs:

Single Phase Maximum Input Current Equation

$$\text{Input Current} = \text{Maximum Power} / (\text{Efficiency})(\text{Power Factor})(\text{Minimum Input Voltage})$$

Three Phase Maximum Input Current Equation

$$\text{Input Current} = \text{Maximum Power} / (\text{Efficiency})(\text{Power Factor})(\text{Minimum Input Voltage})(\sqrt{3})$$

These input current calculations are for the worst case: assuming the unit is running at maximum power, operating at a low line condition and taking efficiency and power factor into account.

AN-22***Simple voltage mode/current mode testing of a high voltage power supply*****Issue**

The proper and complete testing of a high voltage power supply requires specialized skills and equipment, with safety being the primary focus. Customers with a “questionable” high voltage power supply frequently ask if there is something they can do to simply test the operational capability of a unit in question. The following procedure can provide a quick but limited “kick the tires” to see if the power supply has basic functionality. No special equipment is needed but appropriate high voltage safety skills are required.

Safety Warning:

High voltage power supplies are dangerous and can have lethal consequences. Please utilize all safety information provided in the power supplies manual and on the website. If you do not have the skills and high voltage safety qualifications to perform these tests, please do not attempt these tests. If in doubt, contact Spellman High Voltage and return the power supply to the factory for evaluation. Your safety is your responsibility, if there is any doubt in your ability to safely perform these tests... **DO NOT TRY TO DO THESE TESTS.** Return the power supply to Spellman for assessment.

Concept

Virtually all of Spellman’s high voltage power supply have voltage and current programming capability, allowing the unit to function as either a voltage source or a current source. Most people use our power supplies as a voltage source... set the current programming to maximum and adjust and control the output voltage of the power supply. But it is also possible to use the unit as a current source... set the voltage to maximum and adjust and control the output current of the power supply. We can check the functionality of Voltage Mode and Current Mode fairly simply without any specialized skills and equipment. This is just a rudimentary test but it could be helpful in determining basic functionality of a questionable power supply.

Voltage Mode

To test the power supplies ability to function in Voltage Mode we are going to run it into an “open circuit”, otherwise known as no load testing. A properly functioning high voltage power supply should be able to make full rated output voltage into an open load condition. For the purpose of these instruction the assumption is the power supply is a full feature rack mount unit. These instructions will work for modular units too, but the programming and feedback signal will need to be measured and interpreted. Make certain the power supply is properly connected to the input power and grounded as outlined in the operator’s manual. Confirm the power supply is powered off, wait 5 minutes for any residual charge to dissipate and remove the high voltage output cable from the power supply.

Apply input power to the power supply. Turn the power supply into standby (HV OFF). Adjust the current programming to maximum, adjust the voltage programming to minimum. Enable the power supply into HV ON. Slowly turn the voltage programming up. The corresponding output voltage should be displayed on the front panel voltage meter. The word VOLTAGE should be displayed in the fault diagnostic panel, indicating the unit is operating in Voltage Mode. Dial the output voltage up to maximum, the power supply should have no problem making full output voltage into an open load.

Put the power supply into standby (HV OFF). Remove the input power from the supply and wait 5 minutes for any residual charge to decay.

Current Mode

To test the power supplies ability to function in Current Mode we are going to run it into a “short circuit”. A properly functioning high voltage power supply should be able to make full rated output current into a short circuited load condition.

We are going to need to use the high voltage output cable that was disconnected in the previous test. This is important for safety, the “load end” (unterminated) of the high voltage cable needs to be connected to the ground stud on the rear panel of the power supply. Only after this is done can you insert the terminated end of the high voltage cable into the rear panel of high voltage power supply. The output of the power supply is now safely connected to ground.

Apply input power to the power supply. Turn the power supply into standby (HV OFF). Adjust the voltage programming to maximum, adjust the current programming to minimum. Enable the power supply into HV ON. Slowly turn the current programming up. The corresponding output current should be displayed on the front panel current meter. The word CURRENT should be displayed in the fault diagnostic panel, indicating the unit is operating in Current Mode. Dial the output current up to maximum, the power supply should have no problem making full output current into a short circuited load condition.

Put the power supply into HV OFF. Remove the input power from the supply and wait 5 minutes for any residual charge to decay. Remove the terminated side of the high voltage cable from the power supply. Next disconnect the unterminated (load end) of the high voltage cable from the rear panel ground stud.

Summary

These two test have shown that the voltage loop (programming and feedback circuitry) is functioning and the current loop (programming and feedback circuitry) is functioning. Because we operated the unit into an open circuit and short circuit we really didn’t test the power supplies ability to make power. But these two simple tests can confirm that the power supply has some basic functionality and check proper voltage and current programming and feedback capability.

AN-23

SL HV OFF and HV ON circuitry explained

The diagram below shows a simplified SL HV ON/OFF schematic, functionally it is correct but it does not show all the actual circuitry. In reality, there are additional interlocks and circuitry that can turn off the high voltage if a fault is detected. The switches shown are the front panel HV OFF and HV ON switches. The three points on the simplified schematic are brought to the rear panel and are identified as pin 14, pin 15 and pin 16:

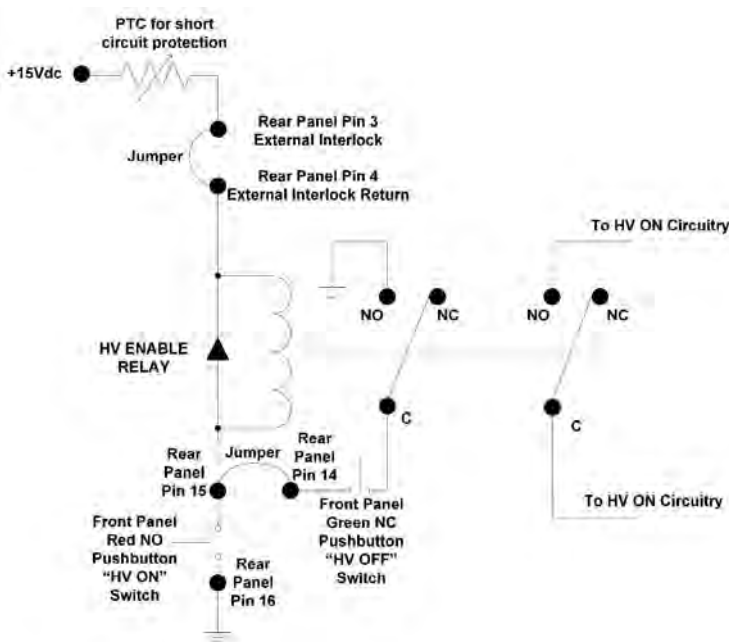

SL HV OFF and HV ON Circuitry

Pin 14: One side of the normally closed front panel HV OFF push button switch

Pin 15: The common point between the front panel HV OFF and HV ON push button switch

Pin 16: One side of the normally closed front panel HV OFF push button switch

HV OFF

Pins 14 and 15 are normally closed. They must be connected together to use the green front panel HV OFF switch, we ship the unit with a jumper in place. If you want to use a remote HV OFF switch, remove the jumper and connect a normally closed switch between these two points. If you open the remote switch (or press the front panel HV OFF switch), the unit will turn the high voltage off. Any remote HV OFF switch is placed in series with the front panel HV OFF switch.

HV ON

Pins 15 and 16 are normally open. When you momentarily press the red front panel HV ON switch you toggle and latch the high voltage on (assuming the interlock is closed and there are no faults present). If you want to use a remote HV ON switch, connect a normally open switch across pins 15 and 16. A momentary contact closure will turn the high voltage on. Any remote HV ON switch is placed in parallel with the front panel HV ON switch.

Spellman has used this high voltage ON/OFF circuitry on many of our rack mounted high voltage power supplies for decades, with outstanding results.

AN-24

Environmental considerations for Spellman high voltage power supplies, X-Ray generators and Monoblock® X-Ray sources

Spellman’s product data sheets have a specification listing titled “Environmental”. This is where the products operating temperature, storage temperature and humidity are listed. These specifications if followed should prevent environment matters from becoming a concern. However, we’d like to expand upon a couple of related environment topics that may benefit the users of our equipment.

Keeping It Cool with Adequate Air Intake and Air Exhaust

Many of Spellman’s high voltage power supplies, X-Ray generators and Monoblock® X-Ray sources utilize forced air cooling by self-contained fans. These internal fans provide the required air exchange needed to keep the unit cool during operation. It is important that the air intake perforations in the units’ sheet metal enclosure and the air exhaust perforations and/or fan assembly exhaust vent guard are not blocked or obstructed. Free and unobstructed air flow in and out of the unit is required for proper operation.

Racks: Cool Air Intake Through Side Panels, Hot Exhaust Out the Rear Panel

Many of Spellman’s “rack” style high voltage power supplies and X-Ray generators have a standardized air flow pattern to facilitate mounting in cabinet enclosures. Most units draw cool air in via air intake perforations on the forward half of the side panels of the rack assembly. Most units exhaust hot air out (by an internal fan) via rear panel perforations in the sheet metal, or by a rear panel mounted exhaust fan.

Prevent Recirculation of Air When Mounting Rack Units in Cabinets

When mounting one or multiple Spellman “rack” type high voltage power supplies and/or X-Ray generators in a cabi-

AN-24 (continued)

net it is important to prevent recirculation of air inside the cabinet enclosure. Recirculation would be defined as hot exhaust air from the rear panel of the unit finding its way back into the cool air intake perforations on the side panels of the unit. To prevent recirculation of air a baffle may be required to physically isolate cool air intake and hot air exhaust. In some situations, a cabinet mount exhaust fan might be required to provide the need air flow. Occasionally both a baffle and exhaust fan may be required to obtain the necessary airflow when multiple units are mounted in a cabinet enclosure.

Operating Power Supplies in Dusty and/or Contaminated, Unregulated Environments

Virtually all products Spellman manufactures and sells are intended for use in what we would informally call a “regulated office like” environment. We’re assuming the operational temperature and humidity specifications will be followed as per the data sheet. In addition, we’re expecting the units to be operated in a regulated office like environment, free from excessive dust/contamination by dry particles or chemical vapors found in various industrial processes. Over the years Spellman has worked with customers with these kinds of unfavorable local environmental situations and have recommended two solutions. The first is relocating the unit to a more “regulated environment”, that is taking the unit out of the unfavorable environment. This might require the use of a longer high voltage cable that could potentially be problematic:

The second solution is locally isolating the unit from the problematic environment via the use of a sealed air-conditioned cabinet. Although this might seem a bit dramatic and costly, we’ve seen this fix “save the day” in several nasty industrial situations.

Summary

Provide your high voltage power supplies, X-Ray generators and Monoblock® X-Ray sources favorable ambient environments and you will be rewarded with years of trouble-free operation.

AN-25

My high voltage power supply is arcing. How can I figure out where the problem is?

Issue

If you have a Spellman High Voltage power supply with a detachable high voltage cable and if arcing during operation is observed, you may be able to find out where the problem is located. This procedure is only applicable for Spellman High Voltage power supplies with a single conductor deep dry well type detachable high voltage cable. This test procedure will not work on X-Ray generators utilizing multiple conductor commercially available X-Ray connectors (like the Federal Standard 75kV X-Ray connector, or the R series connectors) because these connectors are not designed to operate to maximum rated voltage without the mating cable installed.

Safety Warning

High voltage power supplies are dangerous and can have lethal consequences. Please utilize all safety information provided in the power supplies manual and on the website. If you do not have the skills and high voltage safety qualifications to perform these tests, please do not attempt these tests. If in doubt, contact Spellman High Voltage and return the power supply to the factory for evaluation. Your safety is your responsibility, if there is any doubt in your ability to safely perform these tests...**DO NOT TRY TO DO THESE TESTS.** Return the power supply to Spellman for assessment.

Concept

A high voltage cable connects the output of the high voltage power supply to the user’s load. If arcing is observed during operation of the power supply there are three places this arcing could occur from: the power supply itself, the high voltage cable, or the “customer load”. By simply isolating these items we may be able to locate where the problem resides.

Test the High Voltage Power Supply

Spellman’s high voltage power supplies that have a single conductor deep well style detachable cable is designed to operate at maximum output voltage without the cable being inserted. With the AC power removed from the unit and after waiting 10 minutes remove the high voltage cable from the power supply. This will configure the unit to be in a true “no load” condition. A properly functioning power supply should be able to be turned on and dialed up to maximum output voltage. If this can be achieved with no arcing issues observed, then the problem is not with the high voltage power supply. If you do observe popping, snapping, clicking noises inside the power supply, or

AN-25 (continued)

if the ARC light flashes then the problem is with the power supply and it needs to be returned for repair. Please return the high voltage cable along with the power supply.

Test the High Voltage Cable

If the power supply passed the above test, the next step would be to test the high voltage cable. With the AC power removed from the unit and after waiting 10 minutes carefully install the high voltage cable into the high voltage power supply. The “load” end of the high voltage cable should be placed within an appropriately sized grounded Faraday enclosure for user protection. Additionally, the load side of the high voltage cable may need to terminate to a corona relief surface to suppress any corona from being generated. Spellman’s HVD series of high voltage dividers (HVD100, HVD200 or HVD400) can provide this function. Make certain adequate air breakdown distances are used for the voltages for the maximum voltages expected during the test.

If everything is connected properly and it is safe to do so, turn on the high voltage power supply and dial it up to maximum output voltage. If you can achieve maximum rated output voltage with no arcing observed, the high voltage cable is fine. If arcing is observed, then the high voltage cable needs to be replaced. Turn off the high voltage power supply, remove the AC power to the unit and wait 10 minutes for any residual charge to dissipate. Use a short circuit ground discharge stick and touch the center conductor of the high voltage cable to be sure any residual charge is dissipated before proceeding.

Test the Customer Load

Use a short circuit ground discharge stick and touch the center conductor of the high voltage cable to be sure any residual charge is dissipated before proceeding. Connect the center conductor of the high voltage cable to your load as you see fit for your application.

Make certain that anything associated with, or referenced to, the high voltage output is located inside a grounded Faraday enclosure for user safety. Be certain adequate air breakdown distances are used for the anticipated high voltage settings. Make certain all high voltage interlocked panels are connected and closed, and it is safe to power up the high voltage power supply with the load attached to it.

Turn on the high voltage power supply and slowly dial up the voltage. If you observe popping, snapping, clicking noises external to the high voltage power supply or if the ARC light flashes then the problem is with your customer connected load and it needs to be reviewed to determine why the arcing is occurring and what remedies are required.

AN-26

Capacitor charging and Spellman high voltage power supplies

Issue

Spellman High Voltage power supplies are used in a wide variety of applications including capacitor charging. Not all capacitor charging applications can be addressed with our units, so we typically have the customer fill out a capacitor charging questionnaire. We review the application and see if a standard unit will work, if a modified standard unit will work, or if we do not have a hardware solution and need to decline the opportunity. What is the fundamental issues with Spellman High Voltage power supplies and capacitor charging? Let us explore this in a bit more detail.

How Spellman Makes High Voltage

Virtually all the products Spellman designs, manufactures and sells make use of a circuit called a Cockcroft-Walton multiplier circuit. This circuit is a cascaded network of diodes and capacitors used to generate high voltages. This circuit has been around for a long time, originally used for early particle accelerator experimentation in the 1930’s. By placing multiple stages of this circuit in series extremely high voltages can be generated, but this method of generating high voltage has its benefits and drawbacks.

Cockcroft-Walton Multiplier Circuit

Unlike the early uses of this circuit, today’s high frequency switch mode inverter techniques operate in the tens or hundreds of kilohertz, reducing the value of overall capacitance needed to operate. Still the capacitance can be significant and once charged to the desired output voltage, the stored energy in the multiplier’s capacitance can be substantial. Spellman inserts a series limiting resistor assembly between the output of the Cockcroft-Walton multiplier and the output connector of the high voltage power supply to limit the short circuit discharge current to a reasonable level.

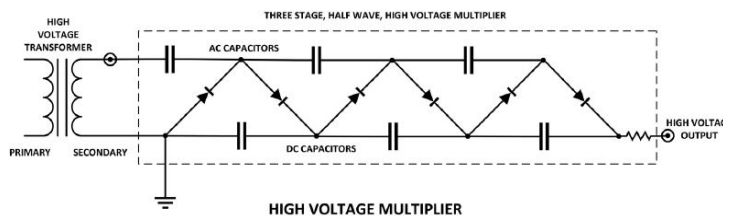

Series Limiting Resistor

This series limiting resistor assembly must dissipate the I²R losses of the rated output current of the power supply along with dissipating the energy stored in the multiplier during a short circuit. During a short circuit, the voltage on the output connector falls to zero but the capacitance of

AN-26 (continued)

the multiplier is still charged. The full output voltage is impressed across the resistive output limiting assembly. Whatever energy is stored in the multiplier capacitance is dissipated as heat in the resistive output limiting assembly. This resistive output limiting assembly is of limited physical size and power handling capability. Frequently the resistive output limiting assembly is encapsulated with the rest of the multiplier assembly, further impeding its ability to dissipate thermal energy.

Overheating the Series Output Limiting Resistor Assembly

Individual or intermittent arcing will not damage the power supply, the series output limiting assembly has ample capability to dissipate this kind of power dissipation. The “problem” arises when repetitive, continuous arcing occurs. Under this scenario the power being dissipated in the series output limiting resistor can exceed its power handling capability. The series limiting resistor can thermally overheat and fail, permanently damaging the power supply. This type of damage is considered abuse of the power supply and repairs will not be covered under warranty.

Arc Intervention Circuitry

Many of Spellman’s high voltage power supplies have arc intervention circuitry that monitors arcing and can intervene on the power supplies behalf to prevent continuous arcing from damaging the power supply. Some of Spellman’s less expensive modular power supplies have no arc intervention circuitry so care must be taken to protect the power supply from continuous arcing.

Capacitor Charging Applications

The kind of capacitor charging applications that Spellman’s power supplies are suited to address are the low frequency or “single shot” application where heat build up in the series output limiting resistor assembly will not be an issue. If your application requires multiple Hertz, tens or hundreds of Hertz of short circuit discharges continuously, a true “capacitor charging power supply” would better serve your application. These dedicated cap chargers are designed to minimize output capacitance and have very capable output limiting circuitry making continuous short circuit discharging of the output a non-issue.

Spellman has just a few real “cap charging” power supplies, the CCM, CCM500 and the CCM1KW. These are true capacitor charging power supplies, but they are somewhat limited in output voltage capability.

Capacitor Charging Questionnaire

If your application is capacitor charging, please speak to a sales individual and fill out our capacitor charging questionnaire so we can evaluate your requirement and see if we have a hardware solution we can recommend.

AN-27**What does the fault “regulation error” mean?****Situation**

Many of Spellman’s rack mount power supplies have a dead front style fault diagnostic display on the front panel. This display will provide information on the normal operation of the power supply like Voltage Mode, Current Mode, External Interlock Open, External Interlock Closed and various other normal operating parameters of the power supply. This display will also show when faults or problems occur with the power supply, with Regulation Error being one of them.

Regulation Error

If one of the two controlling loops (be it voltage mode or current mode, dependent on voltage /current programming parameters and load impedance) is in active control of the power supply, the unit is behaving normally. If neither the voltage loop nor the current is in active control, then both loops are saturated in a vain attempt to make the voltage/current/power being requested, causing the power supply to shutdown displaying a “Regulation Error” fault.

How Spellman Tests the Regulation Error Circuit

Spellman puts a full rated resistive voltage/current load on the output of the unit under test, demanding full output voltage/current and power. We then lower the AC input voltage using a variac so the AC input voltage falls below the low line parameters (typically -10% or more of the nominal rated AC input voltage). Here we are ‘starving’ the power supply with less than adequate AC input power to make full rated output power. Both the voltage loop and current loop saturate trying to maintain output power, creating a temporary “Regulation Error” fault.

The fault can be cleared by pressing the green front panel HV OFF button, (or cycling the AC input power) and bringing the AC input voltage back up to nominal levels.

Regulation Error Faults in the Field

The first thing to check if you experience a Regulation Error fault in the field is confirm the AC input voltage is in the nominal range. If you still experience a Regulation Error fault there is a good chance something has broken damaged inside the power supply preventing it from making full voltage/current/power. Typically, in this case you will need to contact the Spellman Customer Service group and arrange for the power supply to be returned to the factory for repair.

AN-28

Pulsing applications and Spellman high voltage power supplies

Spellman designs, manufactures and sells DC high voltage power supplies. Typically, our power supplies are used in continuous load applications. There are some unique applications where users try to draw large bursts of current for short periods of time. These applications can be problematic as our power supplies are not designed for this type of usage. Depending upon the situation there may be ways of coming up with a workable solution, so let us see what that might look like.

Low Output Capacitance and Series Limiting Resistor

Our “high frequency” switching power supplies have considerably less output capacitance than older, traditional line frequency power conversion topologies. Additionally, to limit the short circuit discharge currents to reasonable levels we put an output limiting resistor in series with the output. This low capacitance and series limiting resistor work against the case of trying to pull large pulse currents from our high voltage power supplies. There is not much internal storage capacitance to “hold up” the output voltage during these pulsed demands. Additionally, the series limiting assembly will cause large voltage drops.

Customer Supplied Buffering Capacitor

One possible way to address this issue is for the customer to place a pulse rated buffering capacitor on the output of the high voltage power supply. Assuming the user knows the magnitude and duration of the current pulses drawn, they can size the external buffering capacitor for the voltage droop they can tolerate. If this pulsed current demand is happening in a repetitive fashion, please realize it may take the tens of milliseconds for the voltage loop of the power supply to respond and correct for it. This provides reason to size the buffering capacitor erring on the larger size of more capacitance.

Isolation Resistor

Placing an isolation resistor between the high voltage power supply output and the buffering capacitor can help prevent large pulse currents from being drawn from the power supply. Once a continuous train of pulses is established this will look like an average load to the power supply. The power supply will readjust to find a new point of equilibrium. Any change to the pulse train will look like a load change to the power supply, requiring it to take time to find the new point of equilibrium.

AN-01

Fundamentals of X-Ray generator – X-Ray tube optimization

X-Ray generators and X-Ray tubes work together to provide performance and reliability demanded in today's applications. Spellman X-Ray generators offer customers sophistication and flexibility to customize how the generator operates tubes provided by all manufacturers in order to meet the specific goals of your project. To harness the full potential of Spellman X-Ray generators it's important to understand a few fundamental rules when setting up your generator in order to optimize performance and reliability. If you have a specific question just ask the experts at: asktheexperts@spellmanhv.com

Understanding how to match the settings of the X-Ray generator to the X-Ray tube**Confirm Specifications**

Before ordering your high voltage generator/ X-Ray tube/high voltage cable confirm the filament current and voltage, output kV and mA specifications of the generator meet the requirements of the X-Ray tube. Additionally check the high voltage cable pinout and length are per the Spellman High Voltage product specifications.

Set Max Filament Limit

One of the most critical settings is the Filament Limit adjustment. The Filament Limit set point limits that maximum output current of the filament power supply to protect the filament of the X-Ray tube. This setting will make it impossible for the generator to exceed this value in any circumstance. It should be set at or below the X-Ray tube manufacturer's specification. When set below the maximum X-Ray tube specification, the Filament Limit should be 10-15% higher than the filament current required to achieve the maximum programmed emission current (mA) at the lowest kV. Remember, filament maximum values are different than the REQUIRED values for emission. Setting 10-15% over the needed emission current values provides head room as well as better transient response. But always keep the limit level at or below the manufacturers recommended maximum filament current specification.

Set Filament Standby (Preheat)

The Filament Standby current (referred to as Filament Preheat on some product lines) is the idle current supplied to the X-Ray tube filament during X-Ray Standby (HV OFF/X-Ray disabled) conditions. The Filament Preheat set point is typically around 1A - 2A, but the X-Ray tube manufacturer should be consulted. It is perfectly fine to set standby current to zero, if fast emission ramping is not required.

Program Ramp Times

If programmable kV, mA and filament ramp times are available for the product you are using, these should be set to the slowest time tolerable for your applications. Refer to specific product manuals for these features or consult with Spellman High Voltage.

Effects of cable length on filaments**AC filaments**

AC filaments operate at high frequency so there is a potential difficulty driving power down the long cable due to its impedance. Standard units are calibrated with a defined cable length (for example the DXM is 3 meters) during factory testing. Changing the high voltage cable length may have an effect on the filament current calibration. If you have a concern about the cable length in your system, contact Spellman High Voltage.

DC filaments

For DC filaments the DC copper losses of the cable need to be considered. The wire gauge used should be sized for the current requirement. Standard units are calibrated with a defined cable length and wire gauge (for example the DXM is a 3 meter, 18 gauge wire).

Filament voltage requirements

Spellman uses current regulation for filament control. The voltage needed by the X-Ray tube filament is simply a result of Ohms law: $V=I \cdot R$. If you are not sure what the current and voltage requirements of your X-Ray tube are, consult the X-Ray tube manufacturer or Spellman High Voltage.

mA loop response and how we design X-Ray generators to operate with a majority of X-Ray tubes

Not all X-Ray tubes have the same filament characteristics. Different filament characteristics require a different control response to provide stable emission current output. Our standard units have an emission control response designed to work with many X-Ray tubes. Some X-Ray tubes fall outside of this category and require custom emission loop compensation to insure stable emission output. Consult Spellman High Voltage about your specific X-Ray tube being used.

An explanation of our KV, mA and filament ramp speeds and why?

Spellman standard products are designed to be used with a wide variety of X-Ray tubes and applications. Because some applications require faster rise times (less than 2 seconds) and other applications prefer slower rise times, the standard product ramps are defaulted to speeds that will meet most requirements and applications. For example, the DXM has a default 5 second kV ramp and a 2.5 second filament ramp, but

AN-01 (continued)

can be adjusted. Please consult with the X-Ray tube manufacturer about ramp time specification requirements for the specific X-Ray tube to be used.

Of course we can customize and slow down the ramps, but why not make the standard product ramps as slow as possible?

Some applications require faster rise times (less than 2 seconds) and other applications prefer slower rise times. The standard product ramps are defaulted to speeds that will meet most requirements and applications. Please consult with Spellman High Voltage about customizing ramps speeds to meet your application. Slower kV ramp times can be better for the X-Ray tubes, allowing a controlled voltage distribution along the tube. Slower Filament and mA ramps can minimize stress on the X-Ray tube filament. Consult with the X-Ray tube manufacturer for recommended ramping for your tube.

Remember an X-Ray tube is a limited lifetime device. It degrades over time as the filament evaporates. The higher the current the faster the evaporation and the shorter the life of the tube. The slower voltage and current changes are applied to the filament the less stress and longer the life.

Example of faster ramp times

- Filament Limit Set Point 3.6A
- Preheat Set Point 0.0A
- CH1 (YELLOW) mA Tube Current Monitor
- CH2 (GREEN) kV Monitor (1 second ramp time)
- CH3 (PURPLE) Filament Current Monitor (750ms ramp time to 3.6A filament limit)
- CH4 (BLUE) mA Program Ramp (1 second ramp time after a 1 second hold period at 5% of mA program value)

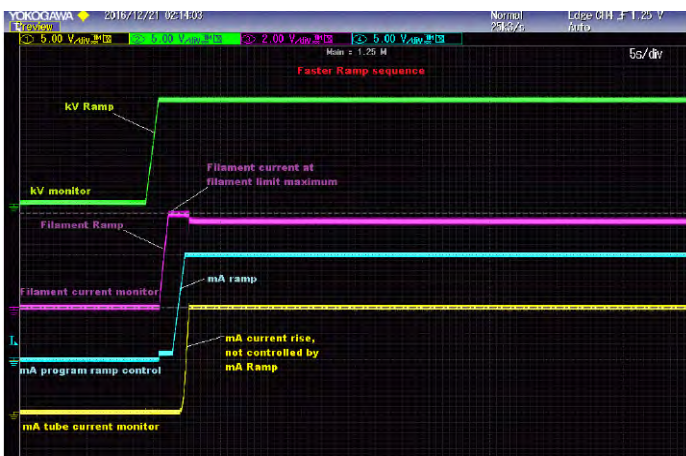

As you can see in the waveform graph the faster ramp sequence does not allow enough time for the X-Ray tube filament to achieve the required temperature for emission current before the mA ramp starts. This causes the filament current to ramp to the maximum filament limit and stay at that level for several seconds while the filament reaches required temperature for the requested emission current. The mA current rise is not controlled by the mA ramp and hence may have a slight over shoot.

Example of slower ramp times

- Filament Limit Set Point 3.6A
- Preheat Set Point 0.0A
- CH1 (YELLOW) mA Tube Current Monitor
- CH2 (GREEN) kV Monitor (10 second ramp time)
- CH3 (PURPLE) Filament Current Monitor (22 second ramp time to 3.6A filament limit)
- CH4 (BLUE) mA Program Ramp (5 second ramp time after a 30 second hold period at 5% of mA program value)

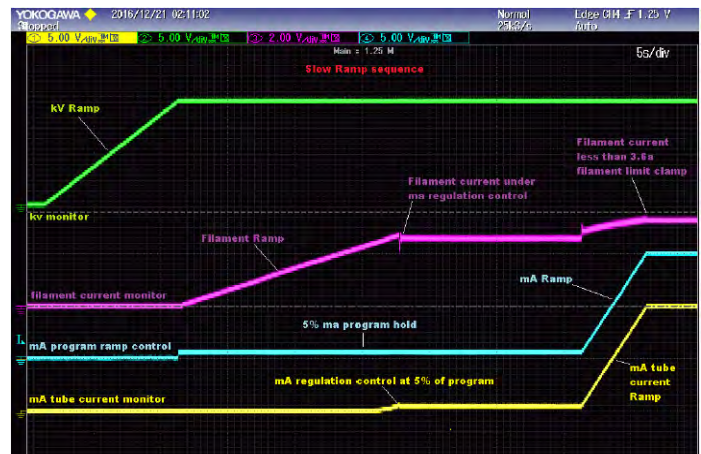

As you can see above in the waveform above, at the completion of the kV ramp the mA program steps to 5% of the programmed mA value. At the same time the filament slowly ramps up allowing mA regulation to take control. After mA regulation is in control and stabilizes, the mA ramps to the final program value with no over shoot. Note the filament current never goes to the maximum filament limit set point of 3.6A.

AN-02

Common X-Ray tube failure modes

Introduction

X-ray tubes are a proven, cost effective way to produce X-radiation useful in the medical, inspection and scientific fields. For over 100 years X-ray tubes have made advances owing to new applications, materials, processing equipment and design. Today two types of tubes dominate: rotating anode tubes used primarily for medical purposes from 25 kilovolts (kV) to 150 kV, and stationary anode tubes used in the inspection industry from 25 kV to over 400 kV with some in the million volt range. Stationary anode tubes typically operate at 1-20 milliamperes in nearly continuous duty and can be on for many hours at a time. Rotating anode tubes operate in excess of 1000 milliamperes but are used primarily in a pulsed mode of about 1 millisecond to 10 seconds.

In the production of X-rays less than 1% of the energy produces useful X-rays while the remaining 99% is transformed into heat. This factor limits the useful life of the X-ray tube. Many scientific disciplines are required and must be controlled to produce a quality product. These include: thermodynamics, heat transfer, materials science, vacuum technology, high voltage, electronics, atomic/radiation disciplines, manufacturing processes, and many lesser but important technologies. The integration and control of the X-ray tube and generator is critical to producing anticipated technical results and long tube life.

Normal Aging

X-ray tubes age and have a limited life because the characteristics and materials used begin a gradual degradation and are consumed so that performance gradually decreases until they no longer perform satisfactory.

Normal Filament Burn Out

The electron beam in an X-ray tube is supplied by a tungsten filament which has been used since the inception of electron tubes and also in incandescent light bulbs. Despite experimentation with other emitters: dispenser cathodes, Lanthanum and Cerium hexaboride, thorium and rhenium doped tungsten, pure tungsten has remained the best filament material. The filament is made from wire which is wound into a helix and inserted into a cup which acts as a focusing element to form the necessary rectangular electron beam. The helix serves to strengthen the filament and provides increased surface area to maximize electron emission.

Tungsten wire is readily available and processed into useable forms. The wire is relatively strong, rugged and keeps its shape when stresses such as vibration and shock are controlled. X-ray tube manufacturers stabilize and strengthen the filaments with a process called recrystallization. This changes the raw fibrous wire microstructure into one which the crystal structure has a length to diameter ratio in the range of 3 to 6. Recrystallization is accomplished by heating the wire very rapidly to about 2600 Celsius in a few seconds and holding it there for a very short time. A common parameter for filaments is the filament life. When hot tungsten slowly evaporates from its surface, the higher the temperature the greater the evaporation rate. Ideally tungsten evaporates uniformly but in practice it begins to form hot spots at crystal grain boundaries which are visible as “notches”. Hot spots evaporate tungsten more readily and the wire thins more at these locations, ultimately burning open. The higher the filament temperature the more the tungsten grains grow with time and the quicker the notching progresses. Additionally if high inrush currents are allowed with a cold filament this accelerates burn out by over heating the thinned spots.

For filament life, a reduction of about 10% of the wire mass is considered to be the end of life. This represents a reduction of 5.13% in the wire diameter and the filament has attained about 98% of its life. (Tungsten Filament Life Under Constant-Current Heating, A. Wilson, Journal of Applied Physics, vol. 40 No. 4 Pg. 1956, 15 March 1969) (This reference also has a good picture of a notched filament run under direct current conditions and an unnotched wire run under alternating current conditions.) A 5 or 6% decrease in diameter is considered end of life by many manufacturers.

Accelerated Filament Burn Out

X-ray tube characteristics are affected by several factors including: tube current, tube voltage, anode to cathode spacing, target angle and the focal spot size (electron beam size). The focal spot size is affected by: surface area of the wire, helix pitch (the number of turns per inch), helix diameter/length, proudness of the filament in its focus cup, and the shape of the cup itself. Only the anode to cathode high voltage and the filament current (temperature) determines the tube emission. The emission is governed by the Richardson-Dushman equation which is very dependent on filament temperature; the higher the temperature, the more emission.

AN-02 (continued)

The filament in a tube runs hotter when more tube current is demanded from the tube at a fixed voltage or when more tube current is demanded but the tube runs at a lower voltage. For example two cases are compared for a stationary anode tube. First: a tube operating at 160 kV @ 1 milliamper (mA), compared to 5 mA. In this tube the filament is calculated to run about 2086 degrees Kelvin, compared to 2260 degrees Kelvin at 5 mA. The 174 degree increase produces an evaporation rate 21 times as much for the 5 milliamper operation compared to 1 mA. (“The Rates of Evaporation and the Vapor Pressure of Tungsten...”, Jones and Mackay, Physical Review, Vol. XX No. 2, August 1927.) Second, for the same tube operated at 40 kV @ 5 mA compared to 160 kV and 1 mA the temperatures are 2300 K and 2086 K respectively which reduces life by a factor of about 43 times. Interestingly, a relatively small decrease in life is experienced with a low tube current when the tube voltage is reduced; for example 160 kV vs. 40 kV, both for 1 mA, only reduces the life by a factor of 1.3 and 160kV vs 40kV both at 5mA reduces by 2.1 times.

In summary:

- 160 kV@5 mA vs. 160 kV@1 mA 21 times less filament life
- 40 kV@5 mA vs. 160 kV@1 mA 43 times less filament life
- 40 kV@1 mA vs. 160 kV@1 mA 1.3 times less filament life
- 40 kV@5 mA vs. 160 kV@5 mA 2.1 times less filament life

This shows that tube current increases (produced by filament temperature increases) are much more important than tube voltage changes. Individual tube types as well as individual tubes of a single type will vary from these examples.

Filament failures due to burn-out are caused by high operating temperatures; the higher the temperature, the sooner the filament burns open. Tungsten evaporates from the filament surface but in a non-uniform way, so hot spots are formed which evaporate more rapidly. Hot spots occur at tungsten crystal faces which evaporate preferentially at different crystal surfaces. The higher the temperature of the filament and the longer it operates there, the larger the crystals grow. Long life is achieved by having the crystals long and narrow along the axis of the wire and keeping the temperature as low as possible.

Slow Leaks

X-ray tubes require a high vacuum to function. Glass-to-metal seals and metallic brazed joints which are suitable to begin with, start to fatigue and some times begin to allow minute amounts of gas to enter, gradually increasing the gas pressure. Tube performance begins to suffer due to materials evaporation and high voltage arc-over which can be caused by higher gas pressure.

Inactivity

Lack of operation allows gases within the tube vacuum to build and migrate along surfaces. When the filament is energized and high voltage is applied arc-over can occur especially at higher operating voltages. Most manufacturers recommend a warm-up procedure depending on the inactive time period. Necessarily this is a one-size-fits-most procedure but a single procedure may not fit all. For some cases, additional extended operation including higher power or voltage operation called seasoning, is necessary and helps the tube operation. This may not work satisfactorily or not at all and the tube must be replaced.

Glass Crazing



Most tubes are manufactured with glass as the vacuum wall vessel but the glass also performs the task of insulating the tube electrodes (cathode, anode and ground) from leakage currents and arc-over. With time and depending on use factors, metal (tungsten) from the anode and filament begins to evaporate onto the glass surfaces causing eventual arc-over and tube failure. The arcing disturbs the evaporated material and can cause glass insulators to become etched. This condition is often referred to as “crazing” or “etching”.

Various methods are used to mitigate the effects of the evaporation including: sand blasting the glass (which increases the insulating path), using a hooded anode on stationary anode tubes (a hood or shroud reduces target evaporations onto the glass), metal center vacuum walls (which reduce filament evaporation onto the glass in rotating anode tubes and some stationary anode tubes), and the use of ceramics. These techniques do not eliminate metal evaporation but greatly reduce its deposition onto the glass and ceramic insu-

AN-02 (continued)

lating surfaces thus postponing the arc-over tendency. The techniques can produce other undesirable effects, for example sandblasting glass can lead to glass particle release which causes arc over.

Arcing

Arcing is a common problem in all high voltage systems. Some causes have been mentioned above: high gas levels in the vacuum, evaporation of conducting metal on insulator surfaces, and crazing or etching of insulators which in turn produce higher gas pressure or degrade the insulators ability to hold off the high voltage. Other causes such as small insulator or metal particles which are freed by operation or can be generated within the tube produce gas and conductive films on insulators. These particles can cause small but focused electron beams which trigger arcs.

Target Micro-cracking

When power is supplied to the tube, an electron beam strikes the target and the temperature under this beam rises rapidly. For stationary anode tubes the power and temperature is relatively low and equilibrium temperature is reached within fractions of a minute. The tungsten target surface can easily reach melting temperature of tungsten (3400 degrees Celsius) but is limited to about 400 degrees Celsius (750 Fahrenheit) so the tungsten disc will not detach from its copper base. The temperature rise at the target surface causes stresses which can result in minute cracking at the target surface. Over time and with on/off cycling these cracks grow and some of the electrons in the beam fall into these cracks so the resulting X-radiation is altered.

Tungsten absorbs some of the radiation from the cracks and the radiation intensity is reduced and the energy of the X-rays becomes harder (having higher energy rays). Running tubes at lower power and lesser target angle) also reduces this tendency.

For rotating anode tubes whose power capability can be up to 1000 times greater than a stationary anode, target micro-cracking is much more severe and its effects are therefore greater. Temperatures of the target focal spot in a rotating anode tube can reach 2800 degrees Celsius (over 5000 Fahrenheit). The reduced radiation vs the number of exposures is often referred to as "radiation fall-off". Micro-cracking is reduced by using the lowest necessary power, the largest possible focal spot and longer exposures at reduced power rather than shorter exposures at higher power. Such criteria are also applicable to stationary anode tubes. Micro-cracking reduces heat transfer which increases the temperature of the focal spot which increases tungsten target evaporation onto the glass.

Accidental Damage

While not a high failure cause, accidental damage can be caused by not following recommended protocols during installation and operation. Misunderstanding, unfamiliarity, and assumptions can cause accidental damage. The carpenter adage applies: measure once, cut twice; measure twice, cut once. For X-ray tubes, check and double check.

Bearings

Rotating anode tubes bearing failure can be problematic. All mechanical systems wear out and stop working so the trick is to achieve longevity. High temperature and high speed will reduce bearing life the most. With operation, the lubricant (which is usually silver or lead metal) wears off of the ball and race surfaces leaving steel-to-steel contact which leads to binding or jamming. With conservative use bearings usually outlast other failure mechanisms. Radiation requirements and operation should be carefully reviewed in detail when choosing a rotating anode over a stationary tube.

Deficiencies in manufacturing
Immediate Failures

No matter how hard a manufacturer tries, not all tubes are made exactly alike. Small differences exist, but the manufacturer needs to make sure such differences do not impact the tube operation.

Weed Out by Test

After a tube is produced and processed it is subjected to a battery of tests to complete final processing but more importantly to make sure that it meets the performance standards established for that model. The tube is subjected to quality testing. The primary testing

AN-02 (continued)

is the high voltage stability. Each tube is subjected to high voltages typically in excess of 15% or more over its maximum operating voltage while operating at maximum power capability. Such processing removes gasses and particles and seasons virgin surfaces to operate at high voltages. The tube is then subjected to a performance test to check its high voltage stability such that no or limited arcs occur over a specified time frame when operating at maximum rated voltage. Cathode emission, filament volt ampere characteristics, focal spot size, thermal loading and other pertinent characteristics are tested and measured. For rotating anode tubes additional tests such as noise, vibration, coast time and others are performed to assess the rotor and bearing performance. Tubes not meeting specifications are rejected/scrapped but analyzed to find offending causes so corrections can be made to the manufacturing process.

Hold Period

Sometimes despite satisfactory testing if tubes are held for 2-4 weeks they do not perform satisfactorily especially under high voltage conditions. The change in performance is usually caused by tiny vacuum leaks which cannot be detected by normal means but produce gases which do not allow good (high voltage) performance. Normal thermal cycling can induce leaks or voids open up and introduce deleterious gasses. Such degradation of performance is rare but occurs and in some instances longer idle or normal inventory rotation times reveal additional failures.

Improper Materials

Modern materials like: oxygen free copper, controlled expansion cobalt alloys, rhenium infused tungsten, high hot strength alloys, vacuum grade graphite, high temperature brazes, as well as ceramics and technical glasses have vastly improved tube performance. Because of such improvements a high level of quality assurance is necessary to guarantee these and other material quality. Testing and certificates of compliance are often used to insure supplier quality. Despite these efforts materials not up to standard can creep into the manufacturing process. A good example is oxygen free copper bar which if extruded can contain stringers which cause vacuum leaks. The more costly forged plate and bar must be used. Usually these deficiencies are caught in-house and are not seen by the customer.

Process Failures

New processes such as: vacuum remelted metals, turbo-molecular vacuum pumps, high temperature vacuum processing, high temperature hydrogen gas firing, vacuum brazing and electro polishing also provide improved X-ray tube performance. Automation has

helped insure more consistent product. However if these processes/equipment utilized become faulty or the control is lost, a well-tuned process can easily fail and marginal or reject tubes can result.

Latent Failures

Latent or unpredictable failures which occur in time are often unforeseen and sometimes may not be attributable to a known cause.

Process Optimization

Many processes used on tubes and their parts have evolved over many years and through practical experiences. Unless there is very clear contrary evidence manufacturers are reluctant to change a process for fear of unknown consequences. For example an anode with a graphite disc brazed to its back for a rotating anode tube must be outgassed prior to assembly. If the temperature is too high, damage in the braze and its interface could occur, but if too low and adequate outgassing might be compromised. In a stationary anode, high temperature on the anode helps outgassing, but how high and for how long can the temperature be before (hidden) damage occurs? Many processes fall into this category, such as: outgassing, vacuum pumping, and seasoning. Being too conservative risks unsatisfactory performance, being too aggressive risks damage. It's difficult to find a suitable compromise and once a process works it is often best to leave it alone.

Marginal or Poorly Understood Processes

Some failures are caused by effects that are not well known or for which side effects of various processes are not known. Why does dielectric oil sometimes become dark and have foreign material, yet the tube operates OK? Other systems exhibit arcing yet the tube and cooling oil and surroundings look and test OK. The lubrication on the ball bearings in a rotating anode is a good example of not thoroughly understanding a process. The lubricant, usually lead or silver, is plated by chemical or physical evaporation methods and is blotchy in nature and not so uniform. Some run-in of the tubes is required to distribute the lubricant more uniformly. The average thickness is important also; too thin and bearing life is compromised, too thick and the tubes run rough and often jamb. Historical results and trial and error guides the process, but physical reasons are not well understood.

Failure Analysis/Untraceable Causes

Failure analysis can reveal the cause of a failure and is an important process used by manufacturers to find latent and immediate failures. Sometimes the problem is obvious, other times a lot of analysis and testing is involved to uncover a root cause. Any person involved with failure analysis knows that despite a strong effort,

AN-02 (continued)

many times it is not possible to find a root cause. Either the failure destroys definitive evidence, or the disassembly during analysis removes the evidence. Some times not enough evidence is found to make a definite conclusion. The best that can often be done is to extrapolate to a cause.



A common failure for relatively long lived tubes is arcing. The most common proven causes of arcing are: high residual gas pressure, degradation of insulators and spurious electron emission (commonly called “field emission”). The first two subjects were touched on earlier. For field emission microscopic particles (both metallic conductors and non-metallic insulators) can cause small electrical currents typically in the nanoampere range which are emitted simply due to very high electrical fields. These minute currents which emanate in a beam form can under certain conditions charge insulators which then discharge thereby inducing an arc. The charging can also cause failure of the insulator in the form of a puncture which is a minute hole in the insulator causing loss of vacuum. Alternately particles can detach, accelerate thus pick up high energy in the electric field, and burst upon impact inducing an arc. The impact often causes secondary damage in the form of impact debris which in turn causes more field emission.

Manufacturers stress cleanliness in an effort to reduce particulates, usually assembling tubes in clean rooms and utilizing various processes such as ultrasonic cleaning or electropolishing to remove particles. Despite such efforts minute particulates still enter the tube. To mitigate particulates, every new tube is “seasoned” or exposed to high voltage operation up to about 25% of its maximum operating voltage in order to burn off or remove particulates to inactive parts of the tube. Seasoning a tube under cold conditions does little good so the tube must be operated through a particular thermal protocol of which many that are possible. The schedules for such seasoning comprise considerable experimentation and evaluation but are yet not always perfect. It is extremely difficult to get a tube which never arcs.

Application mismatch

Early mammography is a good example of initial tube mismatch when a standard diagnostic tube was used to produce mammograms. The resulting diagnosis was rather poor and radiation burns often resulted. Over several years, it was learned that molybdenum radiation, at voltages of about 30 kV with very small focal spots designed into tubes which especially fitted the anatomy was very effective in providing early diagnosis of breast cancer. New tubes were designed to meet these requirements and today they are the gold standard for essential early detection.

Low kV/High mA Emission

A common mismatch can occur when a tube designed for high voltage use is used at lower voltages (typically one half or less of maximum), the filament has to be run at higher current to overcome the limited emission. In a particular rotating anode tube operated at 125 kV and 300 mA when decreasing to 50 kV and 300 mA the filament must be operated at 16 % more power to overcome the lower tube voltage. Since the filament cools by radiation with temperature proportional to the 4th power (T^4), a 16% increase means only a 3.8% increase in filament temperature. While this seems small the tungsten is evaporating at about three times the rate at the higher power resulting in three times less filament life in this case. If the tube is operated at higher tube current (>300 mA in this case) at 50 kV, the filament current must be increased and even lower filament life results. Often such a mismatch must be accepted because a manufacturer is reductant to produce a special design especially if sales will be limited.

Temperature/Life

A basic rule for X-ray tubes is that temperature is the enemy. The more power applied, the shorter the tube life. However without adequate power there may not be enough X-radiation intensity to get the job done. Filament evaporation causing unwanted metallic deposits will eventually lead to insulator arc over. Operating the target at higher temperature will not only eventually cause target evaporation, but the radiation quality in-terms of energy distribution and intensity will begin to change and be reduced due to micro-cracking.

Thermomechanical stresses are present during tube operation. The glass to metal seals are stressed when heated and the more heat the higher the temperature leading to increased stress. Ultimately minute particles can break off or the glass forms fine cracks which are increased by radiation passage. Mechanical fatigue is always present due to thermally cycling and the more the cycling the quicker fatigue develops. Higher power causes higher temperature which accelerates fatigue. Operating the X-ray tube at the lowest useable power extends life.

AN-02 (continued)

Improper drive by the power supply

In an X-ray source, the power supply provides all the necessary power to operate the tube including the filament and often the rotor supply for a rotating anode tube. Additionally the supply contains the logic and interlocks used by the system. Thus the supply is an integral part of the X-ray source and both act in concert.

Supply Impedance

One of the most critical characteristics of the supply is its impedance. For stationary anode tubes, which operate at a few hundred watts, the impedance can be high meaning it contains a lot of resistance so in case of an arc damage to the tube and sensitive electronics is minimized. Arcing is usually extinguished when the voltage supporting the arc is reduced. When the current in an arc passes through the high voltage resistance, the voltage across the resistance increases thereby reducing the voltage on the tube and other parts of the high voltage circuitry. If the gas pressure in the tube gets so high as to sustain an arc the impedance also protects the supply and associated electronics. Nothing can be done to a tube to improve its performance when its gas level becomes too high.

Unfortunately high impedance also means that if arcing starts due to a particle or field emission or light evaporation, there is often not enough energy stored to clear-up or evaporate the cause and arcing may continue. A rotating anode tube operates under much higher power conditions sometimes over 100 kilowatts or almost 1000 times a stationary anode. Here the supply cannot have high impedance otherwise it would not support the required power. In these cases, it is often necessary to limit the stored energy to typically less than 10 joules. High voltage cables and voltage multiplier capacitors will store such energy and damage to the tube in an arc can result. Ten joules is not a fixed value, only a guide as some tubes operate satisfactorily with more energy stored and others won't operate with less energy. The capacitance becomes more troublesome at higher voltages as the energy is proportional to the voltage squared.

DC/AC Filament

Typically filaments are operated under alternating voltage/current conditions. There are three basic reasons. First it was historically easier to control and supply alternating currents (AC) and secondly there tends to be grain growth when direct currents (DC) are used causing brittle fragile filaments to form over time and burn open sooner. Lastly but less important is that under DC conditions at one end of the filament a small fixed potential will exist equal to the filament operating potential which can distort the focal spot by biasing it slightly with respect to the focusing cup. The effect is more pronounced with smaller focal spots and high emission conditions. With AC such bias alternates between both ends of the filament and so washes out.

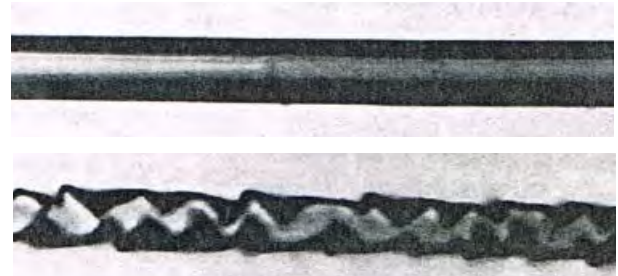

For filaments heated by direct current, a phenomena of notching occurs especially for thin filaments. In this case some tungsten ions form from the evaporated tungsten atoms and are attracted toward the negative end of the filament and deposit themselves forming a series of "notches". These notches are thinner than other sections of the filament and lead to hotspots with accompanying greater evaporation and ultimately burn-out. Filament life reduction of two to ten times is reported by operating with DC rather than AC. Modern power supplies that use DC filaments derive this from high frequency converter. Under these conditions, a low amplitude high frequency ripple in the order of 10s of kHz is present on the filament signal that minimizes the notching effects.

AN-02 (continued)**High Frequency**

The glass-to-metal seals in a tube are made from Kovar or similar alloy consisting of iron, nickel and cobalt all of which are highly magnetic. The seals include the feedthroughs which carry the filament current. Under high frequency the magnetic materials are subject to magnetic hysteresis, eddy currents and the skin effect which sap the energy from the current flow. This phenomena requires that the supply deliver more power than compared to non-magnetic materials in order to overcome the loss. The higher the frequency the more the losses. The loss of power would heat the feedthroughs and the mechanical stressing effect in the seals is not well understood. Currently frequencies of up to 40 kHz are employed. For the cathode and anode, high frequency, high voltage supplies are employed, but these are rectified to DC.

Rotation Speed/Brake

For rotating tubes, bearing life as well as filament evaporation is a major consideration for tube life. When an exposure is called for, stator power is applied so the tube anode comes up to a rotation speed (revolutions per minute). Such minimal speed is specified by the manufacturer and the synchronized speed has historically four values based on the frequency of the commercial power; for 60 Hertz, the maximum speed is 3600 rpm or at triple speed 10800, for 50 Hertz power, 3000 rpm and 9000 for triple speed. These speeds are usually called "low" or "high" speed for normal singular frequency or triple frequency respectively. In practice the rotor can never quite reach this speed because friction in the bearings and less than complete magnetic coupling between the stator and rotor reduce the speed. In fact, the stator/rotor system is only about 10% efficient compared to commercial motors which are usually over 90%. For these reasons manufacturers generally specify a minimum speed typically 3000, 9500, 2800 and 8500 or values similar to allow for slip from the synchronous speed.

When an exposure is initiated, the stator power is applied for a specified amount of time to reach the minimum speed and depends on: the moment of inertia of the anode, (very roughly proportional to the heat storage capacity), the voltage applied to the stator, and the frequency of the applied voltage (high or low speed). Typically this rotor "boost" time is 1.5 to 6 or more seconds. After the boost is applied, the stator goes into the "run" mode where a reduced voltage (typically 80 to 100 volts) is continuously applied to maintain the minimum speed. Often it is left to the installer to adjust the boost time to meet the minimum speed and that can

become a practical problem to implement. Reed tachometers and synchronous strobe lights can measure the rotational speed. The thermal state of the anode must be considered; a hot anode will come to a lesser speed than a cold anode due to increased friction and decreased magnetic coupling. Once the exposure is made the rotor speed is reduced or braked by applying voltage to only one winding of the stator. Braking is done to quickly reduce bearing rotation but equally important to pass through the rotor resonance quickly. All rotors have a natural resonance frequency and at this point the rotor/anode can vibrate noticeably. To get through this resonance speed quickly and minimize any damaging effect, the brake voltage is applied. Typical resonance frequencies are about 4000 to 5000 rpm (65-80 Hz.), it is especially important to brake after high speed operation. Considering the usual shorter filament boost and longer rotor speed time it can be seen that the X-ray system sequence of events is: call for exposure, apply stator boost, apply filament boost, apply exposure high voltage pulse, reduce filament to idle, break anode speed. Modern power supplies have adjustment to all of these time sequences.

Filament Boost

When an X-ray tube is not producing X-rays (i.e. there is no high voltage applied to the cathode and anode) its filament is in the so called idle (or preheat) mode. It has current running through it but it is below the emission point where tube current would be drawn. When ever an exposure is required the filament current is "boosted" to a predetermined current which allows a particular tube current to flow when high voltage is applied to the tube. When X-rays are no longer needed, the high voltage is switched off and the filament is returned to its idle current.

Typical filament boost times range from about one half to one second. This technique is especially important for a rotating anode tube where the tube currents are high and filament life is saved by operating it only when X-rays are needed. The filament idle current is chosen so that evaporation from the filament is a very small fraction of the filament current necessary for high emission thus minimizing evaporation at idle. If the tube current is sufficiently low, some stationary anode tubes are not boosted at all and the filament might be brought from a no power condition. Continuously pulsed systems can present a problem with evaporation because if the pulse repetition rate is high, there is not enough time between pulses to boost the filament before another pulse comes. Normally in these cases the filament is then run in the boost mode until all the pulsing is finished. Modern power supplies all adjustment to all of these time sequences.

AN-02 (continued)

Logic Circuits

As can be seen from the forgoing description, the logic sequencing and their performance is critically important. Add other systems such as interlocks, imaging sequencing, radiographic object requirements, and other system requirements it can be seen that functioning and reliability of the logic systems is imperative if nothing is to go wrong. Sometimes tube arcing can cause transients initiated by current surges or high voltage interruption to produce circuit failures to the logic. Modern power supplies have isolated logic circuits that protect the sensitive electronics from transients under normal operation and arcing.

Filament Limit/Filament Preheat Settings

One of the most critical settings is the Filament Limit adjustment. The Filament Limit set point limits that maximum output current of the filament power supply to protect the filament of the X-Ray tube. This setting will make it impossible for the X-Ray generator to exceed this value under any circumstance. It should be set at or below the X-Ray tube manufacturer's specification.

When setting the Filament Limit below the maximum X-Ray tube specification, the Filament Limit should be 10-15% higher than the filament current required to achieve the maximum programmed emission current (mA) at the lowest kV setting to be used. Remember, filament maximum values are different than the REQUIRED values for emission. Setting 10-15% over the needed emission current values provides head room as well as better trainset response characteristics. Always keep the Filament Limit level at or below the manufacturers recommended maximum filament current specification. The Filament Standby current (referred to as Filament Preheat on some product lines) is the idle current supplied to the X-Ray tube filament during X-Ray Standby (HV OFF/X-Ray disabled) conditions.

The Filament Preheat set point is typically around 1 amp to 2 amps, but the X-Ray tube manufacturer should be consulted. A good guideline to consider is the maximum Filament Preheat level should be limited to 50% of the Filament Limit specification. It is perfectly fine to set standby current to zero if fast emission current ramping is not required.

Tube enclosure (housing) considerations

The X-ray tube must be enclosed in a suitable container in order to: prevent X-rays from emanating in all directions, provide suitable high voltage insulation and allow cooling of the tube/system. For a stand-alone X-ray tube the container is referred to as the housing, tube assembly or radiation source, and for a system in which the power supply is combined with the tube it is usually called a Monoblock® (Spellman registered trademark).

Dielectric (Oil) Leak

The dielectric, usually oxidation inhibited transformer oil, must provide high voltage insulation to prevent arcing from all high voltage surfaces. If oil leaks develop that usually means air also leaks in to the housing and if the air enters the high voltage field area it will cause an arc-over. If arcing continues, carbon from disintegration of the oil will begin to coat surfaces and they cannot be restored. Oil seals are often made by "O" rings and buna N rubber is suitable for the inhibited oil. Some materials such as neoprene are not suitable as they swell in this oil.

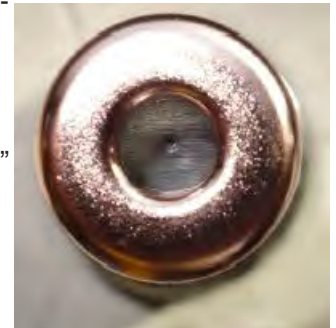

Normal recommendations from the O ring manufacturers for compression percentages are about 5-10% and do not apply. About 25% compression is actually used as the O rings under typical high housing temperatures take a set and loose resilience and may begin to seep.

The oil used contains absorbed gasses which must be removed by vacuum treating to prevent their release in the housing. Such treating increases the dielectric strength as measured in units of volts per distance. Typical values are in excess of 30 kilovolts per inch. An important consideration is the materials used inside the housing, usually plastic insulators. These can leach plasticizers or other chemicals which can dissolve in the oil and degrade the dielectric strength. Temperature enhances the leaching. Care must be exercised to test materials used in the housing, even for new manufacturing lots of these parts.

AN-02 (continued)**Overheating**

Overheating can cause aging not only in the tube but in the housing. Many systems have a heat exchanger which utilizes a fan and sometimes a pump to circulate the oil. It is imperative that these exchangers be kept clean. Dust is the major culprit and will inhibit both natural air convection and forced (fan) air convection. The result is that the housing becomes overheated, a maintenance schedule should be established.

Ambient Temperatures

Ambient temperatures need to be adhered to as specified by the manufacturer. A typical ambient is 25 or 30 Celsius, and under high load conditions, the housing can rise to 75 or 80 Celsius, a typical limit. Thus the temperature increase can be about 50 degrees and if the ambient is higher than specified, this temperature rise will be added to the ambient so that over temperature results. Enclosures, often used in test and to stop radiation leakage can cause ambient temperatures to rise above recommendations. Also it is not uncommon to find plastic or cloth covers used to “protect” the equipment, but these only frustrate the convection air flow and can easily lead to overheating.

Housing Attitude

A tube housing, with or without a heat exchanger can become hot on the top part and not on the bottom. This is because the dielectric cooling oil forms strong convection currents which rise like the smoke from a cigarette and carry heat to the top of the housing. Care must be exercised to insure the best housing attitude for operation. Often thermocouples can guide and reveal hot areas, but good thermal contact is necessary for accurate measurements.

Cable/Ground Connections

Although it seems obvious, good electrical connections are a necessity. Grounding especially as well as other connections such as stator, over temperature switches and high voltage cables are all equally important. Tight screw connections without frayed contacts and wires are a must. High voltage cable connections are particularly critical because if air is included it will ionize in the high field areas and arc through the insulation. Usually a high voltage grease is used to seal out air and allow intimate contact between surfaces. Once arc trails start they are not repairable. Manufacturer's recommendations for cable insulator installation should be closely followed.

Dielectric Expansion

When heated the oil will expand its volume as all materials do. The X-ray system must have a sufficient volume to allow for this expansion. On the cold side when the system is shipped, volume for shrinkage must be allowed. This expansion and contraction is usually achieved by means of a flexible diaphragm to allow the whole volume change. Good design will allow a safety factor; the greater the better. Safety factors of at least 25% are good. Equally important is the setting of the neutral point in the expansion excursions; the diaphragm must be set to allow the expansion and contraction which will be encountered. These factors are design and manufacturing requirements.

Rating Discipline

One of the most important considerations for tube operation is to operate within the published ratings. Familiarity and planning are the key issues. High voltage and filament power must be reviewed so that long term overheating is not exceeded, short term over power on the anode can cause a focal spot melt. Caution and care are the guidelines. Operation of an unencumbered heat exchanger is equally important. For rotating anode tubes the same applies but additionally the proper rotation must be insured. The individual exposure ratings are important to be sure the proper focal-spot is energized, the correct speed chart is used, the high voltage is observed and proper pulse time is chosen. The charts must be coordinated with the filament emission and volt ampere characteristics so overload is prevented. It is very easy to mix up the charts and misread them. Always double check.

AN-03

Floating filament X-Ray generators and the possible problems that long high voltage cables can produce**Background**

Spellman has been making X-Ray generators for over 3 decades. Most fall into three basic categories:

- Ground Referenced Filamentary Control
- Floating Filamentary Control
- Bipolar Output Filamentary Control

Ground Referenced Filament X-Ray Generators Type

Ground Referenced Filamentary Control X-Ray generators include: XMPG, XLG, FF, DXM, MNX, uX, uXHP, VMX and the PMX. These X-Ray generators typically have a positive output voltage with respect to ground. The filament is DC and is ground referenced. The temperature (amps) of the filament, the voltage potential (kV) and exposure time will determine the output X-Ray imaging characteristics. Since the filament is at ground and DC, implementation of filamentary control for this X-Ray generator is fairly straight forward and simple.

Floating Filament X-Ray Generator Type

Floating Filamentary X-Ray Generators include XMPF, DF, XRF, DXM, DXM100, XLF, DXB, and MFX. These “floating filament” X-Ray generators are different...their filament power supplies are referenced to the negative cathode output voltage. That means that the filament power supply must be controllable (using ground referenced programming and feedback signals) while being connected to the main high voltage output, in some cases at -160kV or greater. Implementing floating filament X-Ray generators are more complicated.

Bipolar Output X-Ray Generator Type

Bipolar Output X-Ray generators utilize a floating filament circuit (think Floating Filament X-Ray Generator) but instead of just leaving the anode at ground, it is elevating it at the same but opposite polarity potential of the cathode. This effectively doubles the voltage across the X-Ray tube, allowing greater output power. The implementation functions like a standard floating filament X-Ray generator, with all the same engineering complexities.

Ground Referenced Filament Driver Circuits

Ground Referenced filament circuits (X-Ray generators with a positive output polarity) are for the most part easier to design and fabricate. The filament supply is typically a small 0 to 5 amp @ 10Vdc power supply. This is relatively simple to implement and design because its ground refer-

enced, and it is DC. Because the filament output is DC, driving long high voltage cable lengths tend to be more forgiving. If there is adequate compliance voltage designed in the DC filament driver to drive the long cable, all should be good. In general, ground referenced DC filament circuits are just simpler, from a design and implementation perspective.

Floating Filament Driver Circuits

Floating Filament Driver Circuits are more complicated from an Engineering perspective because they must be connected (referenced) to the negative high voltage output potential of the cathode of the X-Ray tube. Isolation voltage requirements are for -50kV, -100kV, -160kV or more. Isolation transformers are run at high frequency AC, since transformers only function with AC waveforms. Filament circuits operate in current mode, so obtaining a sample of the actual filament current is easy using a current sense transformer. Here utilizing AC for the filament output simplifies the isolation and sensing requirements of the filament circuit. Typically, the operating frequency for the floating filament circuits are approximately 30 to 40 kilohertz. High enough in frequency to be inaudible and to also high enough to keep the size of the filament isolation transformer magnetics and filament driver circuitry to a reasonable size.

The Problems with Long High Voltage Cables Using an AC Filament

Using high frequency AC for a floating filament X-Ray tube application makes some of the design tasks easier, but there is one potential drawback using this technique. The high voltage cable becomes part of the “tuned resonant circuit” of the AC filament driver and excessive high voltage cable lengths can result in some fundamental operational problems. The standard negative output voltage DXM sold with an AC filament is calibrated with a 10 foot long high voltage cable. Excessively long high voltage cables can have so much inductance the filament driver circuit may not have adequate voltage compliance to drive the long high voltage cables, causing problems operating the X-Ray tube. Basically, all the AC high frequency voltage gets dropped across the long high voltage cable leaving inadequate capability to drive the X-Ray tube filament properly. AC filament circuits are not designed to drive long high voltage cables.

Conclusion/Suggestion

When working with X-Ray generators be it DC or AC filaments, use the sensible engineering approach to try to keep the high voltage cable (or filament cable) as short as reasonably possible.

IEEE Std 510-1983 IEEE Recommended Practices for Safety in High Voltage and High Power Testing

by The Institute of Electrical and Electronics Engineers

SCOPE

Excerpts from IEEE Standard 510-1983 have been listed in this section in order to caution all personnel dealing with high voltage applications and measurements and to provide recommended safety practices with regard to electrical hazards.

Considerations of safety in electrical testing apply not only to personnel but to the test equipment and apparatus or system under test. These recommended practices deal generally with safety in connection with testing in laboratories, in the field, and of systems incorporating high voltage power supplies, etc. For the purposes of these recommended practices, a voltage of approximately 1,000 volts has been assumed as a practical minimum for these types of tests. Individual judgement is necessary to decide if the requirements of these recommended practices are applicable in cases where lower voltages or special risks are involved.

- All ungrounded terminals of the test equipment or apparatus under test should be considered as energized.
- Common ground connections should be solidly connected to both the test set and the test specimen. As a minimum, the current capacity of the ground leads should exceed that necessary to carry the maximum possible ground current. The effect of ground potential rise due to the resistance and reactance of the earth connection should be considered.
- Precautions should be taken to prevent accidental contact of live terminals by personnel, either by shielding the live terminals or by providing barriers around the area. The circuit should include instrumentation for indicating the test voltages.
- Appropriate switching and, where appropriate, an observer should be provided for the immediate de-energization of test circuits for safety purposes. In the case of dc tests, provisions for discharging and grounding charged terminals and supporting insulation should also be included.
- High Voltage and high-power tests should be performed and supervised by qualified personnel.

TEST AREA SAFETY PRACTICES

- Appropriate warning signs, for example, DANGER – HIGH VOLTAGE, should be posted on or near the entrance gates.

- Insofar as practical, automatic grounding devices should be provided to apply a visible ground on the high-voltage circuits after they are de-energized. In some high-voltage circuits, particularly those in which elements are hanged from one setup to the next, this may not be feasible. In these cases, the operator should attach a ground to the high-voltage terminal using a suitably insulated handle. In the case of several capacitors connected in series, it is not always sufficient to ground only the high-voltage terminal. The exposed intermediate terminals should also be grounded. This applies in particular to impulse generators where the capacitors should be short-circuited and grounded before and while working on the generator.
- Safe grounding of instrumentation should take precedence over proper signal grounding unless other precautions have been taken to ensure personnel safety.

CONTROL & MEASUREMENT CIRCUITS

- Leads should not be run from a test area unless they are contained in a grounded metallic sheath and terminated in a grounded metallic enclosure, or unless other precautions have been taken to ensure personnel safety. Control wiring, meter connections, and cables running to oscilloscopes fall into this category. Meters and other instruments with accessible terminals should normally be placed in a metal compartment with a viewing window.
- Temporary Circuits
- Temporary measuring circuits should be located completely within the test area and viewed through the fence. Alternatively, the meters may be located outside the fence, provided the meters and leads, external to the area, are enclosed in grounded metallic enclosures.
- Temporary control circuits should be treated the same as measuring circuits and housed in a grounded box with all controls accessible to the operator at ground potential.

SAFETY RULES

- A set of safety rules should be established and enforced for the laboratory or testing facilities. A copy of these should be given to, and discussed with, each person assigned to work in a test area. A procedure for periodic review of these rules with the operators should be established and carried out.

TECHNICAL ARTICLES ABOUT HVPS and HV ELECTRONICS

Power Supply Use and Applications

SAFETY INSPECTION

- A procedure for periodic inspection of the test areas should be established and carried out. The recommendations from these inspections should be followed by corrective actions for unsafe equipment or for practices that are not in keeping with the required regulations.

NOTE: *A safety committee composed of several operators appointed on a rotating basis has proven to be effective, not only from the inspection standpoint but also in making all personnel aware of safety.*

GROUNDING & SHORTING

- The routing and connections of temporary wiring should be such that they are secure against accidental interruptions that may create hazard to personnel or equipments.
- Devices which rely on a solid or solid/liquid dielectric for insulation should preferably be grounded and short-circuited when not in use
- Good safety practice requires that capacitive objects be short-circuited in the following situations:
 - Any capacitive object which is not in use but may be in the influence of a dc electric field should have its exposed high-voltage terminal grounded. Failure to observe this precaution may result in a voltage included in the capacitive object by the field.
 - Capacitive objects having a solid dielectric should be short-circuited after dc proof testing. Failure to observe this precaution may result in a buildup of voltage on the object due to dielectric absorption has dissipated or until the object has been reconnected to a circuit.

NOTE: *It is good practice for all capacitive devices to remain short-circuited when not in use.*

- Any open circuited capacitive device should be short-circuited and grounded before being contacted by personnel.

SPACING

- All objects at ground potential must be placed away from all exposed high voltage points at a minimum distance of 1 inch (25.4 mm) for every 7,500 Volts, e.g. 50 kV requires a spacing of at least 6.7 inches (171 mm).
- Allow a creepage distance of 1 inch (25.4 mm) for every 7,500 Volts for insulators placed in contact with high voltage points.

HIGH-POWER TESTING

- High-power testing involves a special type of high-voltage measurement in that the level of current is very high. Careful consideration should be given to safety precautions for high-power testing due to this fact. The explosive nature of the test specimen also brings about special concern relating to safety in the laboratory.
- Protective eye and face equipment should be worn by all personnel conducting or observing a high-power test where there is a reasonable probability that eye or face injury can be prevented by such equipment.

NOTE: *Typical eye and face hazards present in high-power test areas included intense light (including ultraviolet), sparks, and molten metal.*

- Safety glasses containing absorptive lenses should be worn by all personnel observing a high-power test even when electric arcing is not expected. Lenses should be impact-resistant and have shade numbers consistent with the ambient illumination level of the work area but yet capable of providing protection against hazardous radiation due to any inadvertent electric arcing.

GENERAL

- All high-voltage generating equipment should have a single obvious control to switch the equipment off under emergency conditions.
- All high-voltage generating equipment should have an indicator which signals that the high-voltage output is enabled.
- All high-voltage generating equipment should have provisions for external connections (interlock) which, when open, cause the high-voltage source to be switched off. These connections may be used for external safety interlocks in barriers or for a foot or hand operated safety switch.
- The design of any piece of high-voltage test equipment should include a failure analysis to determine if the failure of any part of the circuit or the specimen to which it is connected will create a hazardous situation for the operator. The major failure shall be construed to include the probability of failure of items that would be overstressed as the result of the major failure. The analysis may be limited to the effect of one major failure at a time, provided that the major failure is obvious to the operator.

Standard Test Procedures for High Voltage Power Supplies

The following pages provide generalized descriptions of the tests used by SPELLMAN HIGH VOLTAGE ELECTRONICS CORPORATION in its Quality Control program. These generalized descriptions cover tests on a large number of different models which vary widely in output voltage, output current, and other operating parameters.

Detailed test data sheets are available for most models. These individual test data sheets delineate the explicit requirements and permissible acceptance levels for each item to be tested. For additional information, please contact the SPELLMAN Engineering/Test Department.

WARNING!

DANGEROUS VOLTAGES MAY BE PRESENT ON THIS EQUIPMENT WHICH MAY BE FATAL.

Make certain all equipment is SECURELY grounded.

Do not touch connections unless equipment is off and internal and load capacitances are discharged.

Do not ground yourself or work under wet or damp conditions.

Failure to follow Safety Procedures may be fatal.

1. PURPOSE

It is the purpose of this procedure to delineate standard tests to be performed on all power supplies manufactured by Spellman High Voltage. It is intended to be used as a stand-alone procedure and in conjunction with other procedures.

2. HIERARCHY

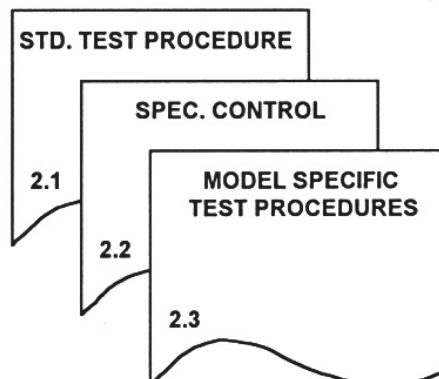

Figure 1. Document Organization

2.1 Standard Test Procedure

Describes generic test to be performed on all power supplies. This combined with the Test Data Sheet provides the parameters for verifying operation of the power supply.

2.2 Specification Control Drawing

Can contain additions or deletions to the standard test procedure.

2.3 Model Specific Test Procedures

Contain elements of both the standard test procedure and the specification control drawing in addition to any detailed instructions needed to verify operation of the supply.

3. HIGH VOLTAGE POWER SUPPLY LOADING METHODS

3.1 Constant Load

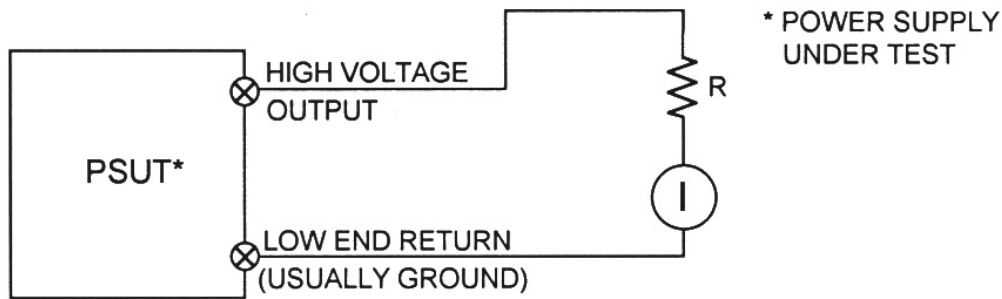

Figure 2. Constant Load Test Set Up

Figure 2 shows a resistor, R, in series with a current meter, I, across the terminals of the P.S.U.T.

CAUTION: The lead from the High Voltage terminal should be high voltage wire. If high voltage wire is not available, ordinary hook-up wire may be used providing reasonable care is exercised to avoid contact with ground circuits.

Resistors must be selected with appropriate voltage and wattage ratings for the specified load requirements. Attention must be given to the physical mounting arrangement, in order to avoid voltage breakdown.

The appropriate current meter, I, should be connected in series with the load resistor, R, in the LOW END RETURN line. This holds the meter at safe, low potentials.

3.2.2 Electron Tube Switch

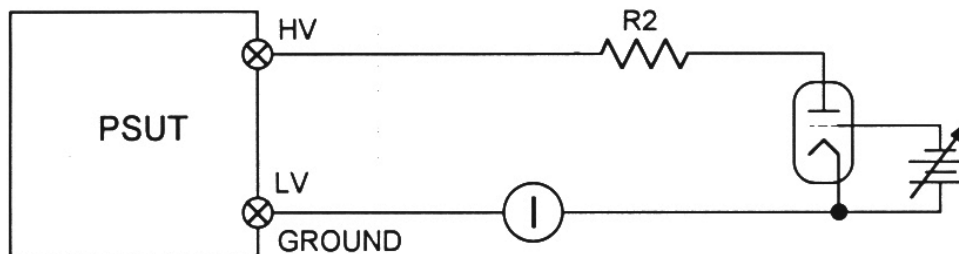

Figure 4. Electron Tube Switch

The circuit of Figure 4 shows a vacuum tube used to cycle the load ON and OFF very quickly. If the grid of the tube is switched from near zero bias to a sufficient negative bias, the tube can be controlled as a switch. Rapidly cycling the load ON and OFF and observing the voltage characteristics is commonly referred to as "Dynamic Load Regulation". Refer to Section 5 for more details.

In addition, the tube can be controlled to provide continuous load adjustment by proper variation of the grid bias. An easy method of attaining bias is by the use of an adjustable cathode resistor.

The manual switch explained in the previous paragraphs are applicable for power supplies with either positive or negative polarity. The electron tube circuit of Figure 4 is shown for a high voltage power supply with positive polarity only. A tube can be used for power supplies with negative polarity by connecting the plate end to low voltage and the cathode end to high voltage. In this case, since the filament and grid supplies will be at high voltage, isolation techniques must be used.

4. VOLTAGE CALIBRATION AND RANGE

This paragraph describes the test set up and method used to measure the output voltage in accordance with the specifications of the specific test data sheet for a given power supply.

4.1 Test Set Up

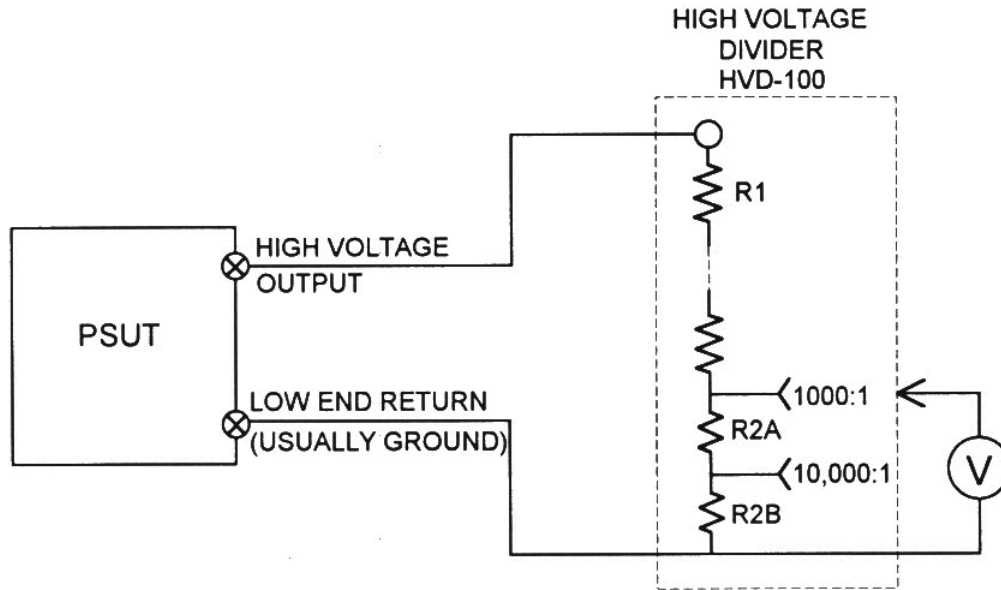

Figure 5. Test Set Up

4.2 Measurement of High Voltage Power Supply Parameters

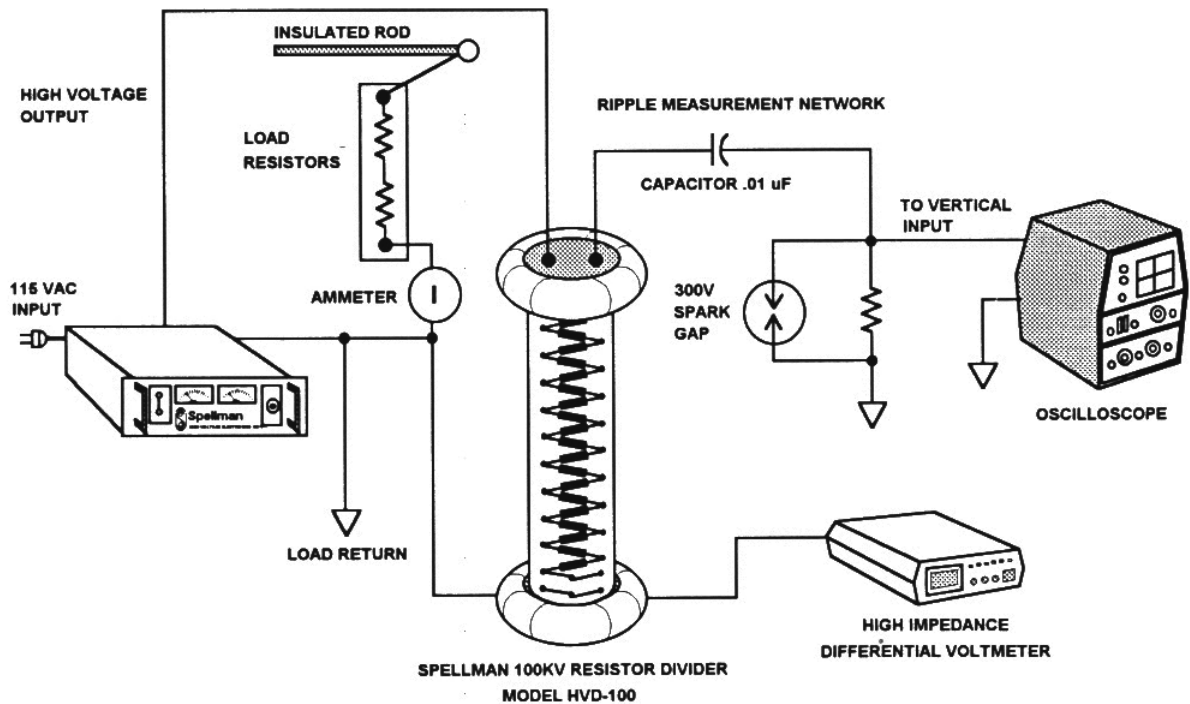

Figure 6. High Voltage Power Supply Test Set Up

4.3 Monitor Instrumentation

The instrument used to measure the divider output voltage must have high input impedance in order to minimize the possibility of introducing errors in measurement due to the loading effects of metering instruments on R2A or R2B (Figure 5). Spellman uses either of two instruments described below for metering (M) in test set-up diagrams, Figure 5 or 6 depending on resolution requirements.

4.3.1 John Fluke Model 8810A

Accuracy of reading including stability: $\pm 0.01\%$ of input
Input impedance: ≥ 1000 Megohms (200mV, 2V, 20V ranges)
Resolution: 10 ppm of range

4.3.2 John Fluke Model 8840A

Accuracy of reading including stability: $\pm 0.005\%$
Input impedance: $\geq 10,000$ Megohms (200mV, 2V, 20V ranges)
Resolution: 1 ppm of range

4.4 Test Method

4.4.1 Connect the HIGH VOLTAGE DIVIDER (HVD) and VOLTMETER as shown in the Test Set-up diagram, Figure 6. The connection between the high voltage output terminal of the P.S.U.T. (Power Supply Under Test) and the high voltage input terminal of the HIGH VOLTAGE DIVIDER should be made with high voltage lead wire.

4.4.2 Connect the P.S.U.T. to a source of input power in accordance with the unit specification. Appropriate input voltage and current monitoring equipment should be included in the test set-up.

4.4.3 All required external adjustment controls should be connected in accordance with the unit specification. Using the specific test data sheet which establishes the proper input voltage conditions and output voltage settings, measure the output voltage according to the above procedures.

4.4.4 Energize the P.S.U.T., exercising reasonable precautions against high voltage hazards.

4.4.5 Measure the output voltage under desired conditions of input voltage and adjustment of voltage controls.

4.4.6 The above measurement is described for what is essentially a "NO LOAD" condition. This is due to the fact that the SPELLMAN High Voltage Divider has an input impedance of 1000 Megohms drawing negligible load current in almost all cases.

Measurements under load may be made as desired by connecting appropriate high voltage load resistors, or other loading devices, across the PSUT, as seen in Figure 6. Current meters should be connected in series with the load resistors in the grounded end to keep the meters at safe potentials. NOTE: See Section 3 for additional information on loading methods.

5. OUTPUT VOLTAGE REGULATION, STATIC AND DYNAMIC

5.1 Definition

In general, most power supply manufacturers in the United States limit the use of the term "regulation" to variations in the output voltage which result directly from changes in the input power source and/or the load resistance.

"Regulation" then, as defined by *Spellman*, and most other manufacturers, specifically *excludes* variations resulting from changes in *temperature* and *time*. Thus, regulation is measured at "constant temperature" and "short" time intervals, where "short" means the time required to make the measurements.

In addition to the two basic components of regulation, i.e. LOAD REGULATION and LINE REGULATION, regulation is further differentiated as STATIC or DYNAMIC variation.

Dynamic regulation is concerned with the output voltage transient response resulting from a line or load change. Of interest are peak deflection and recovery time. *Spellman* defines recovery time as that time required to return from the peak deflection point to within 10% of the new static level. The sketch below details this.

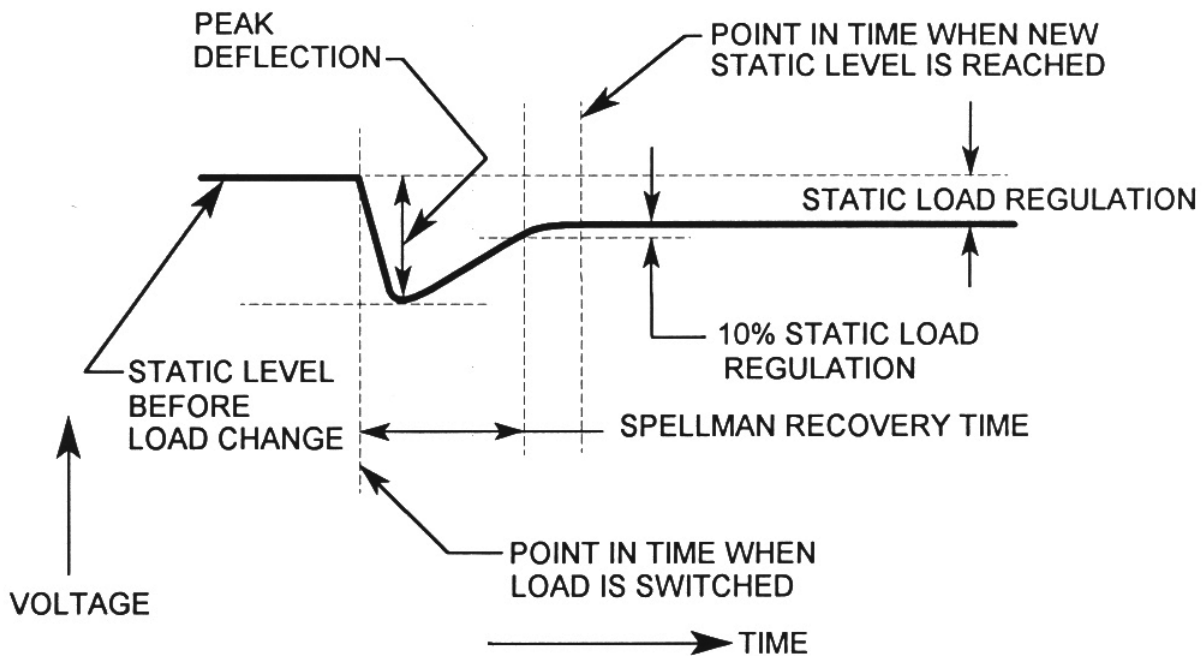

Figure 7. Static and Dynamic Regulation Waveform

5.2 Test Set-Up, *STATIC REGULATION*

- 5.2.1 Connect the output voltmeter circuit as described in Section 4.
- 5.2.2 Connect the PSUT to a source of input power in accordance with the unit specification. Appropriate input voltage and current monitoring equipment should be included in the test set-up. Provide for input power adjustability as required by the specification.
- 5.2.3 Select a loading method (as described in Section 3) which is suitable to the unit specification. Make the necessary connections.

5.3 Test Method, *STATIC LOAD REGULATION*

- 5.3.1 With input voltage maintained constant, make the specified load change using one of the techniques of Section 3.
- 5.3.2 Observe the change in output voltage as read on the voltage monitor. Record for "LOAD ON".
- 5.3.3 Repeat for "LOAD OFF".
- 5.3.4 The above measurements may be made at minimum, maximum and nominal input voltage conditions in accordance with the unit specification. They also may be made at different output voltage conditions, as specified.

5.4 Test Method, *STATIC LINE REGULATION*

- 5.4.1 The same set-up as in Section 5.2 above is used.
- 5.4.2 With output voltage level and load condition set per specification, adjust the input voltage from minimum to maximum.
- 5.4.3 Observe the change in output voltage as read on the voltage monitor. Record.

5.5 Test Method, *DYNAMIC LOAD REGULATION*

- 5.5.1 Connect the output voltage monitor as described in Section 5.
- 5.5.2 With the input voltage maintained constant at its nominal value, establish a square-wave load or pulse load condition as desired.
- 5.5.3 Check that the load current is switching properly by observing the current wave-shape across a current sensing resistor in the "low end" return of the power supply.
- 5.5.4 Observe the dynamic response of the output voltage by using a ripple checker as described in Figure 12.
- 5.5.5 Record the results.

5.6 Test Method, DYNAMIC LINE REGULATION

5.6.1 With load current maintained at a constant level, establish the necessary input voltage switching characteristic.

5.6.2 Observe the dynamic response of the output voltage by using a ripple checker as described in Figure 12.

5.6.3 Record the results.

6. OUTPUT CURRENT REGULATION

6.1 This power supply parameter applies to "Constant Current" or "Current Regulated" supplies. All aspects of "regulation" as described in section 5 above apply here except for the method of measurement.

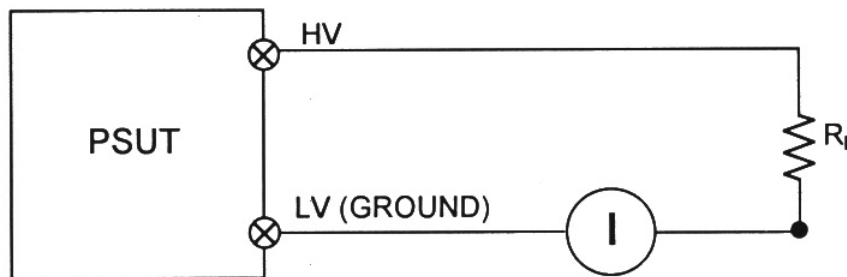

Figure 8. Current Regulation

In Figure 8, the load resistance is represented by R_L . In a current regulated supply, the load resistor, R_L , changes from zero, at the short circuit condition, to some finite value at the rated output voltage condition. The supply cannot maintain regulation into an open circuit, obviously. Thus, load changes are accomplished by "shorting" a portion of the rated load resistor. A current meter, in series with the "low end" of the power supply is used for monitoring the current.

7. CURRENT LIMIT

7.1 This power supply parameter applies to power supplies which although not current regulated, have circuits which will limit the absolute value of the output current.

7.2 Referencing Figure 8, resistor R_L is shorted and the power supply is turned on. The output current is monitored for its peak value and this value is usually 110% of the rated output current.

8. SHORT CIRCUIT

8.1 This test is performed to simulate an arcing condition.

**TECHNICAL ARTICLES ABOUT
 HVPS and HV ELECTRONICS**
 Power Supply Use and Applications

Figure 9. Short Circuit Arcing Test

Using the Plexiglas stick with the conductor connected to ground with a #4 wire, a short circuit condition is applied to the PSUT while the PSUT is energized at full output voltage.

9. INPUT CURRENT

9.1 Input current refers to the current the PSUT draws from its power source (either low voltage DC, or AC mains) during full power operation.

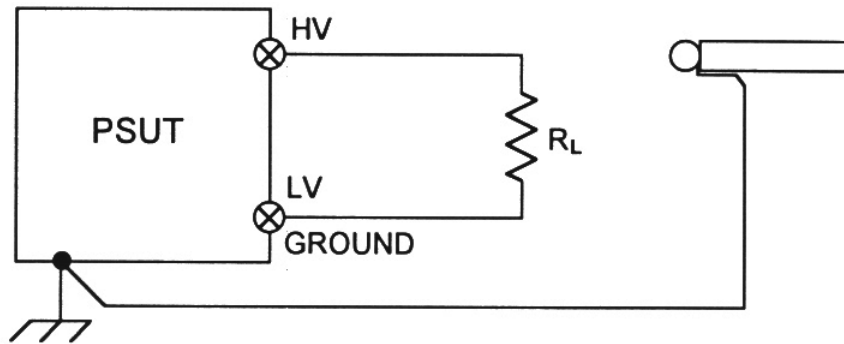
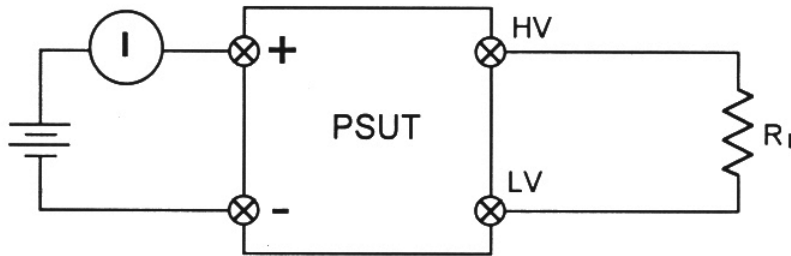

Figure 10. DC Input Current Measurement

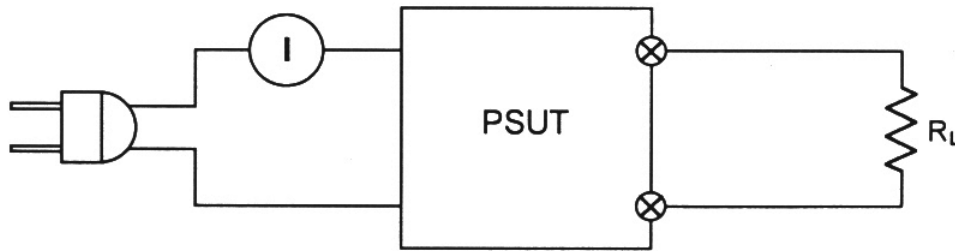

Figure 11. AC Input Current Measurement

A digital multimeter is placed in series with either the positive output of a source or the "HOT" lead of an AC source and the power supply is energized. The parameter is measured at 100% of rated output, at nominal input.

10. RIPPLE

10.1 Ripple Measurement Techniques

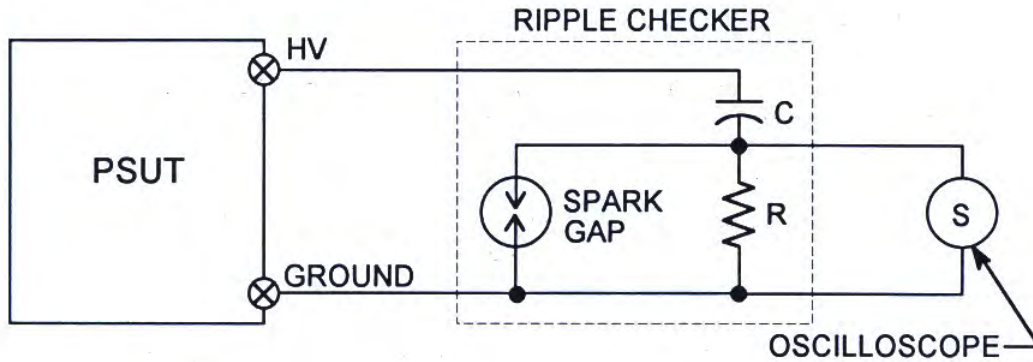

Figure 12. Ripple Measurement

Figure 12 illustrates the technique of using a DC blocking capacitor, C, in series with the power supply output terminal, for the purpose of passing the AC component in the output voltage directly to the oscilloscope, S. Resistor, R, and spark gap, SG, protect the oscilloscope against surges in the output voltage which could be transferred directly through the blocking capacitor to the scope.

The value of C and R must be selected to pass the ripple frequencies of interest with negligible attenuation. The oscilloscope input impedance and frequency response also introduce an error which must be accounted for.

The error in 60 Hz ripple measurements is small for $C \geq 0.01 \mu\text{F}$ and $R \cong 1$ to 10 Megohms. For high frequency components proportionally smaller capacitance values are acceptable.

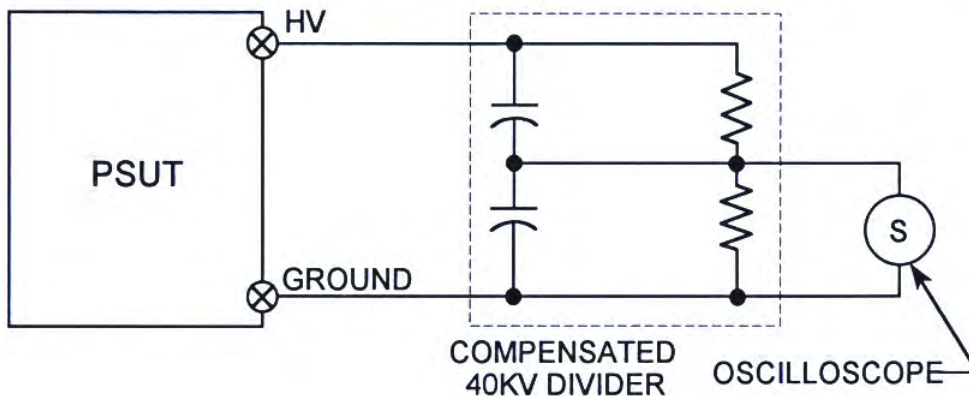

Figure 13. Ripple Measurement

Figure 13 illustrates the use of a compensated 40kV divider for ripple measurements. Although the compensated divider gives an accurate measurement, it suffers from two deficiencies. First, a true no load ripple measurement cannot be made, since the divider itself has 100 Megohms input resistance.

**TECHNICAL ARTICLES ABOUT
HVPS and HV ELECTRONICS**
Power Supply Use and Applications

Second, when the power supply output ripple is relatively low, the 1000:1 divider ratio may attenuate the AC component at the divider output to a level which may be difficult to read.

10.2 Test Method

10.2.1 Set all operating parameters as required by the unit specified. These operating parameters must include all the following:

Output Voltage setting
Load Current condition
Input Voltage condition

10.2.2 Read the ripple in peak-to-peak volts on the oscilloscope. Record.

10.2.3 Divide the measured peak-to-peak value by $2\sqrt{2}$ when rms readings are desired (if the ripple is sinusoidal).

Specifying High Voltage Power Supplies

by Derek Chambers and Cliff Scapellati

INTRODUCTION

In specifying a regulated high voltage power supply for a particular application, it is important to bear in mind that recent advances in power supply technology have made the latest designs smaller, lighter, more efficient than was possible just a few years ago. New designs generally operate at high frequencies in the range of 20kHz to 100kHz, and industry-wide, have virtually replaced all units operating at line frequency, even at high power levels.

All high voltage power supplies must be operated by personnel familiar with the dangers of high voltage. High voltage sources can be lethal! A general guideline for Safety Practices is found in IEEE Standard 510-1983 "Recommended Practices for Safety in high voltage and high power testing."

The two primary factors which have led to these developments are:

- The availability of key power components which have low losses while operating at high frequency
- The development of advanced resonant power conversion techniques

Key Power Components include:

- Faster switching devices (e.g. transistors, power MOSFETS, IGBTs, SCRs)
- Low loss ferrite and powdered iron core materials for choke and transformer cores
- Capacitors with low dissipation factors
- Ultra fast rectifiers which have a low forward voltage drop

Advanced Conversion Techniques include:

- Zero current switching series and parallel resonant inverters (discontinuous mode);
- Zero voltage switching LCC resonant inverters (continuous mode)
- Soft switching and phase controlled resonant inverters
- Quasi-resonant flyback and push-pull inverters

Compared with line frequency operation, high frequencies offer the following advantages in regulated high voltage power supplies:

- Smaller size and weight
- Faster response time
- Lower stored energy
- Higher efficiency



High-voltage supplies such as this multiple-output model use more efficient and higher-performance components and power conversion techniques to reduce weight and improve performance.

TECHNOLOGY

The heart of any high frequency power supply is the oscillator (or inverter) used to drive the output transformer. The specific designs used in the high voltage power supply industry are too numerous to cover in this article since each manufacturer has developed his own proprietary power switching circuits. However, there is one factor, unique to high voltage power supplies, that must be considered in the choice of the oscillator or inverter topology. Specifically, the capacitance which exists across the secondary winding of the step-up transformer must be isolated from being reflected directly across the power switching semiconductor. This isolation can be achieved in a number of ways, including:

- Using a flyback circuit
- Using an inductor or a series resonant circuit between the switching devices and the transformer
- Including sufficient leakage inductance between the primary and secondary windings of the transformer
- Operating as a self resonant oscillator

The choice of oscillator topology is also influenced by the power level of the supply. For instance, a low power unit for a photomultiplier application could use a flyback or self resonant oscillator, while higher power models (e.g. over a kilowatt) would be more likely to use a driven inverter feeding the output transformer through an inductor or a series resonant circuit. The transformer may also be designed to form part of the resonant inverter power circuit.

TECHNICAL ARTICLES ABOUT HVPS and HV ELECTRONICS

Power Supply Use and Applications



Higher-power high-voltage supplies, like Spellman's series SL which are rated up to 1,200W, operate from ac line power.

Properly designed resonant converter designs offer the following desirable characteristics:

- Zero current switching, which improves efficiency and minimize the switching losses in the high power switching devices
- Sinusoidal current waveforms in the power inverter circuit, which greatly reduce RFI interference normally associated with pulse width modulation techniques
- Simple paralleling of the supplies to obtain higher output power
- Inherent current limiting and short circuit protection of series resonant inverters

SPECIFICATION CONSIDERATIONS

Probably the most common mistake engineers make in defining a high voltage power supply is to over specify the requirements for output power, ripple, temperature stability, and size. Such over specification can lead to unnecessarily high cost, and can also lower reliability due to increased complexity and greater power density. If a particular parameter in the catalog specification is inadequate for the application, the factory should be consulted.

UNDERSTANDING SPECIFICATION PARAMETERS

The specifications provided by the power supply manufacturer generally include information on the input and output voltages, the output regulation, ripple, and output stability. Often, more detailed information would be useful to the user. In the following sections, power supply parameters are discussed in greater detail than is normally possible on a standard data sheet, and includes definitions and descriptions of requirements encountered by users of high voltage power supplies.

The specification parameters are covered in the following order:

- Input Voltage
- Output Voltage
- Output Current
- Ripple
- Stability
- Stored Energy
- Pulsed Operation
- Line Regulation
- Load Regulation
- Dynamic Regulation
- Efficiency

INPUT VOLTAGE

The input power source specified for a particular model is determined by a number of factors including the output power capability of the supply and the form of power available in the application. In general, low power high voltage supplies having outputs between 1W and 60W use a dc input voltage of 24V or 28V, while higher power units operate from the ac power line.

DC Input

In many OEM applications, the high voltage supply is just one part of an electronic system in which dc power sources are already available (e.g. 24Vdc, 390Vdc). These existing dc supplies can also be used as the input power source for a high voltage supply. This arrangement is convenient and economical for modular high voltage supplies operating at low power levels.

AC Input

Most high power modules over 100W, and rack mounted models are designed for operation from an ac line source. These power supplies are designed to accept the characteristics of the power line normally available at the location of the user, and these can vary significantly in different parts of the world.

In the United States and Canada, the standard single phase voltage is 115/230Vac at 60Hz, while in Continental Europe and in many other parts of the world, the standard voltage is 220Vac at 50Hz. In the UK, the standard is 240Vac at 50 Hz, while in Japan the voltage is normally 100V at 50 or 60Hz. Most power supplies include transformer taps to cover this range, while some new designs cover the range 90Vac to 130Vac and 180Vac to 260Vac without taps. All countries in the European Economic Community will eventually standardize at 230V at 50Hz.

Power Factor correction and universal input at power levels below 3kW can be specified for most off-the-shelf high voltage power supplies. Higher power units require custom engineering.

TECHNICAL ARTICLES ABOUT HVPS and HV ELECTRONICS

Power Supply Use and Applications

OUTPUT VOLTAGE

High voltage power supplies are generally designed for continuous operation at the maximum output voltage specified in the data sheet. Laboratory bench models and high power rack units are normally adjustable over the complete voltage range from zero to the maximum specified output voltage. In these models, output voltage is indicated on either digital or analog meters, as specified. Modular supplies, on the other hand, may have either a preset output voltage, or a narrow adjustment range, and include monitor terminals instead of meters for measuring the voltage. It is not generally cost effective to specify a power supply with an output voltage greater than 20% over the maximum voltage actually needed in a particular application.

OUTPUT CURRENT

Power supplies are normally designed for continuous operation at the full current specified in the data sheet. Current limiting is normally built into the design to prevent overload current from increasing beyond about 110% of the rated maximum value of output current. Overload trip out can usually be specified to disable the power supply when the normal output current is exceeded. Current regulation is available on most high power racks and modules. This allows the output current to be controlled by a front panel potentiometer or from a remote source, and provides automatic crossover to voltage regulation when the load current is lower than the programmed value.

RIPPLE

Ripple may be defined as those portions of the output voltage that are harmonically related to both the input line voltage and the internally generated oscillator frequency. In high frequency switching designs it is the combined result of two frequencies, namely, the line frequency-related components and the switching frequency related components. Total ripple is specified either as the rms, or the peak-to-peak value of the combined line frequency and oscillator frequency components, and is normally expressed as a percentage of the maximum output voltage.

The amount of ripple that can be tolerated in different applications varies from extremely low values (e.g. less than 0.001% peak to peak in photomultiplier, nuclear instrumentation and TWT applications) to several percent when the output can be integrated over time, such as in precipitators and E-beam welding.

The high frequency ripple may generally be reduced by adding capacitance across the output. On the other hand, when there is a fast response time requirement, the value of output capacitance may have to be reduced. In critical cases, the trade off between slew rate and ripple should be worked out between the customer and the manufacturer of the power supply.

Line frequency ripple:

When operating from an ac input source, line frequency ripple can represent a significant part of the total peak to peak ripple. Typically, the power supply is designed to have equal amounts of high frequency and line frequency ripple when operating at full output power. It should be noted that, in most designs, the magnitude of the line frequency ripple is attenuated and controlled by feedback in the regulation circuits, which normally have bandwidths to include the line ripple frequency.

Switching frequency ripple:

In regulated supplies operating from a dc input, line frequency ripple does not exist, and the ripple frequency is simply related to the switching or oscillator frequency of the supply. To reduce switching frequency output ripple, additional filtering components, or sometimes electronic ripple canceling circuits, may be used. When filtering components, such as shunt capacitors or series resistors or inductors, are added to reduce the ripple, they introduce a delay in the control loop circuits which adversely affects the response time of the supply to changes in input or output conditions. The values of the components which control the phase of the signal in the feedback loop are then changed at the factory to maintain stable operation.

If an application requires particularly small values of either high frequency or line frequency ripple, it is usually possible to provide a lower ripple at one of these frequencies at the expense of increasing the ripple at the other. In these special cases, the requirements should be discussed with the factory before an order is placed.

STABILITY

The following factors affect the output stability of a regulated high voltage power supply:

- Drift in the reference voltage;
- Offset voltage changes in the control amplifiers;
- Drift in the voltage ratio of the feedback divider;
- Drift in the value of the current sense resistor.

All these variations are a function of temperature. Stability in a properly chosen reference device is generally less than 5ppm, and offset errors can be virtually eliminated by careful choice of the control amplifier. This leaves the volt-

TECHNICAL ARTICLES ABOUT HVPS and HV ELECTRONICS

Power Supply Use and Applications

age divider and the current sense resistor as the critical items affecting stability in the output voltage and current.

Since these components are sensitive to temperature variations, they are selected to operate at a fraction of their power capability, and are located away from hot components. However, as the power supply warms up and the ambient temperature around the components increases, there are small changes in the ratio of the voltage divider and the value of the current sense resistor which could affect stability.

The values for stability are usually given after a specified warm-up period (typically 1/2 hour). Good stability is achievable by using a divider with a low value of temperature coefficient, although this becomes more costly.

STORED ENERGY

The stored energy at the output of a high voltage power supply can be dangerous to operating personnel, particularly at the higher voltages since its value is a function of the square of the voltage and the value of the capacitance across the output. Certain types of loads, such as X-ray tubes, are also easily damaged by excessive stored energy in the high voltage power supply when an arc occurs. With power supplies operating at high frequency rather than at line frequency, much smaller values of smoothing capacitance can be used, and the dangers of electrocution are thereby reduced. However, it should be noted that low ripple power supplies which include additional filtering capacitance across the output have correspondingly higher amounts of stored energy. Compared with a power supply operating at line frequency, a switching supply operating at 60kHz could have a fraction of the stored energy of an equivalent line frequency supply, since the value of the output capacitance could be reduced by 1000.

PULSED OPERATION

While some power supplies are designed for dc operation, others can be used in pulsed power applications. In most cases, an energy storage capacitor located inside or external to the supply provides the peak pulse current, and the power supply replaces the charge between pulses. The supply operates in the current mode during the pulse and recharging parts of the cycle, and returns to the voltage mode before the next load current pulse.

Pulsed loads generally fall into one of three categories:

- Very narrow pulses (1usec to 10usec), with a duty ratio of 0.01% to 1%
- Longer pulses (100usec to 1msec), with a duty ratio between 0.05% and 0.2%
- Very long pulses (50msec to 5sec), with a duty ratio between 0.1% and 0.5%

The first category includes pulsed radar applications in which narrow pulses, having durations in the microsecond range, are generated at typical repetition rates between 500Hz and 5kHz.



Compact high power module delivers to 350 watts CW or 600 watts pulse for projection television and CRT testing. 1kV to 70kV with voltage and current programming and monitoring.

The second category covers a broader range of applications such as pulsed electromagnet supplies or cable testing where most of the pulse load current is still provided by a capacitor connected across the output. Some modifications to the output and control circuits are usually needed for reliable operation in these applications, and the details of the load characteristics should be discussed with the factory to ensure reliable operation in the customer's system.

The third category requires a power supply specifically designed to provide more current than its average rated value for relatively long periods. Typical applications are medical X-ray systems, lasers and high voltage CRT displays. It is essential that the actual load conditions are completely specified by the user before placing an order.

LINE REGULATION

Line regulation is expressed as a percentage change in output voltage for a specified change in line voltage, usually over a $\pm 10\%$ line voltage swing. Measurement is made at maximum output voltage and full load current unless otherwise stated. Line regulation of most high voltage power supplies is better than 0.005%.

LOAD REGULATION

Load Regulation is specified at full output voltage and nominal line voltage and is expressed as a percentage change in output voltage for a particular load current change, usually no load to full load. Typical load regulation of most high voltage supplies is better than 0.01%.

High Voltage Power Supplies for Analytical Instrumentation

by Cliff Scapellati

ABSTRACT

Power supply requirements for Analytical Instrumentation are as varied as the applications themselves. Power supply voltages ranging from 3 volts to 300,000 volts can be found within a given instrument. While most voltage requirements can be satisfied with "off the shelf" products, the high voltage requirements are usually addressed by a custom design for a specific application. Custom designed high voltage power supplies can be found in instruments for spectroscopy, capillary electrophoresis, mass spectrometry, electrospray, lasers, spectrometers, X-ray diffraction, X-ray fluorescence, and many other analytical imaging and process applications.

Each application of High Voltage Power will require careful attention to critical variables. Voltage ripple, long and short term stability, repeatability and accuracy are important factors in the consideration of reliable scientific data. Also, as analytical instrumentation finds its way into production process control, reliability and quality are equally important in the considerations for high voltage power supply specification.

Specific performance concerns, technology advances and application information are presented for the designer, specifier and user of high voltage power supplies for analytical instrumentation.

INTRODUCTION

High voltage power supplies are a key component in many analytical instruments. By the nature of analytical applications, test equipment, methods and data must show consistent results. The high voltage power supply, being a critical component within the instrument, must perform consistently also. The high voltage power supply has unique concerns which differentiate it from conventional power supply requirements. By understanding these concerns, the designer and user of Analytical Instrumentation can gain beneficial knowledge.

BASIC HIGH VOLTAGE POWER SUPPLY

A.) Figure 1 shows the basic building blocks of most high voltage power supplies. The Power Input stage provides conditioning of the input power source. The input power source may have a wide range of input voltage characteristics. AC sources of 50Hz to 400Hz at <24V to 480V are common. DC sources ranging from 5V to 300V can also be found. The power stage can provide rectification and filtering for AC signals,

filtering for DC signals and circuit protection. Also, auxiliary power sources to power the high voltage power supply control circuits are typically part of the power input stage responsibilities. It is critical for the instrument designer to understand the input circuit configurations. The power input requirements will affect overall instrument design, customer requirements, and even regulatory requirements.

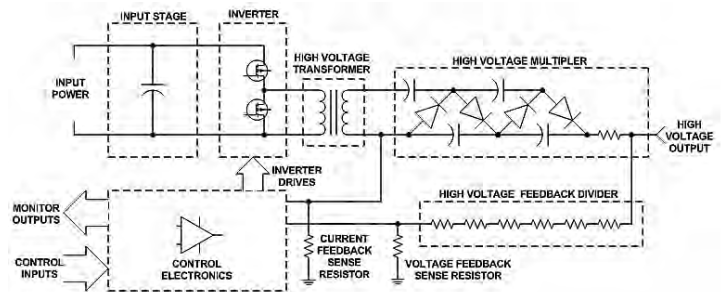

Fig. 1 Basic High Voltage Power Supply

B.) The output of the power input conditioning stage is typically a DC voltage source. This DC voltage provides the energy source for the Inverter stage. The Inverter stage converts the DC source to a high frequency AC signal. Many different inverter topologies exist for power supplies. However, the high voltage power supply has a few factors which may dictate the best approach.

Typically, the Inverter generates a high frequency AC signal which is stepped up by the HV transformer. The reason for the high frequency generation is to provide high performance operation with reduced size of magnetics and energy storage capacitors. A problem is created when a transformer with a high step up ratio is coupled to a high frequency inverter. The high step up ratio reflects a parasitic capacitance across the primary of the high voltage transformer. This is reflected at a $(N_{sec}:N_{pri})^2$ function. This large parasitic capacitor which appears across the primary of the transformer must be isolated from the Inverter switching devices. If not, abnormally high pulse currents will be present in the Inverter.

Another parameter which is common to high voltage power supplies is a wide range of load operations. Due to the presence of high voltage, insulation breakdown, i.e. tube arcing, is commonplace. The inverter robustness and control loop characteristics must account for virtually any combination of open circuit, short circuit and operating load conditions.

TECHNICAL ARTICLES ABOUT HVPS and HV ELECTRONICS

Power Supply Use and Applications

In addition to wide load variations, virtually all analytical instruments need to resolve very low signal levels and contain high gain circuitry. Noise sources, such as power supply inverters must be considered. The Inverter can be a likely source of noise due to the high DI/Dt and DV/Dt created when the Inverter power devices switch on and off. The best approach to reduce the noise source is to have a resonant switching topology. Low output ripple, low input power source ripple and good shielding practices are also important.

All of these concerns, as well as reliability and cost, must be addressed in the High Voltage Power Supply Inverter topology.

C.) The High Voltage Transformer is, historically, where most of the "Black Magic" occurs. In reality, there is no magic. Complete understanding of magnetics design must be coupled with intense material and process control. Much of the specific expertise involves managing the high number of secondary turns, and the high peak secondary voltage. Due to these two factors, core geometry, insulation methods and winding techniques are quite different than conventional transformer designs. Some areas of concern are: volts/turn ratings of the secondary wire, layer to layer insulating ratings, insulating material dissipation factor, winding geometry as it is concerned with parasitic secondary capacitance and leakage flux, impregnation of insulating varnish to winding layers, corona level and virtually all other conventional concerns such as thermal margins, and overall cost.

D.) The high voltage output stage is responsible for rectification and filtering of the high frequency AC signal supplied by the high voltage transformer secondary (Figure 2). This rectification and filtering process in variably utilizes high voltage diodes and high voltage capacitors. However, the configuration of the components varies widely. For low power outputs, conventional voltage multipliers are used. For higher power,

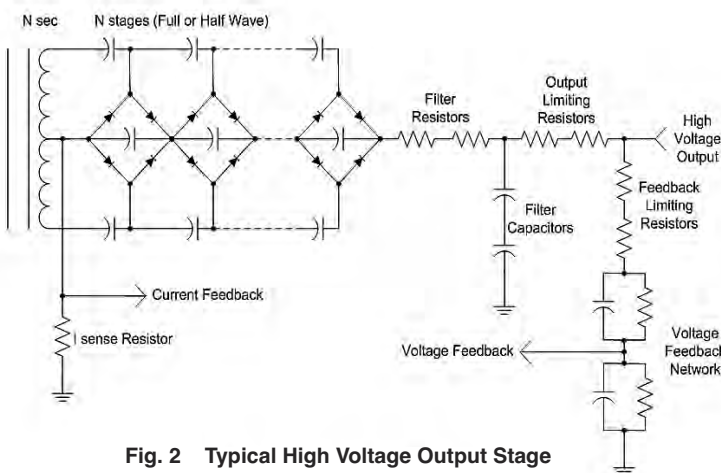

Fig. 2 Typical High Voltage Output Stage

modified voltage multipliers and various transformer techniques can be successful. The high voltage output stage also provides feedback and monitoring signals which will be processed by the power supply control circuits. All of these components are typically insulated from ground level to prevent arc over. The insulation materials vary widely, but typical materials are: air, SF6, insulating oil, solid encapsulants (RTV, epoxy, etc.). The insulating material selection and process control may be the most important aspect of a reliable high voltage design.

E.) Control circuits are the glue to keep all of the power stages working together. Circuit complexity can range from one analog I.C. to a large number of I.C.s and even a microprocessor controlling and monitoring all aspects of the high voltage power. However, the basic requirement which every control circuit must meet is to precisely regulate the output voltage and current as load, input power, and command requirements dictate. This is best accomplished by a feedback control loop. Figure 3 shows how feedback signals can be used to regulate the output of the power supply. Conventional regulation of voltage and current can be achieved by monitoring the output voltage and current respectively. This is compared to a desired (reference) output signal. The difference (error) between the feedback and reference will cause a change in the inverter control device. This will then result in a change of power delivered to the output circuits.

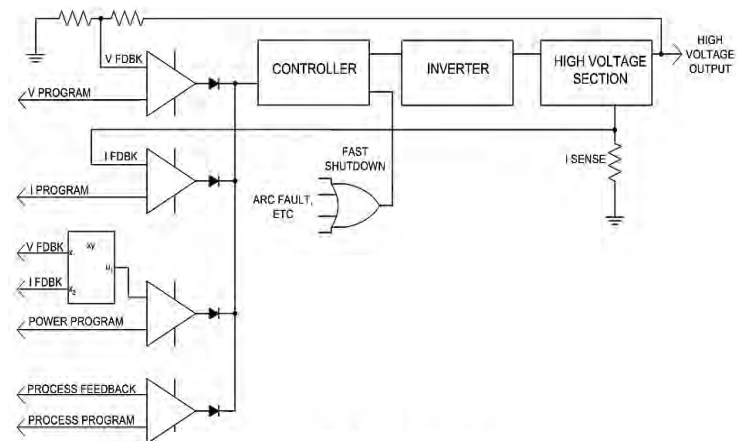

Fig. 3 Power Supply Control Loops

In addition to the voltage and current regulation, other parameters can be precisely regulated. Controlling output power is easily accomplished by an $X \times Y = Z$ function, ($V \times I = W$), and comparing it to the desired output power reference. Indeed, any variable found within Ohm's law can be regulated, (resistance, voltage, current and power). In addition, end process parameters can be regulated if they are effected by the high voltage power supply (i.e. X-ray output, flow rates, etc.).

TECHNICAL ARTICLES ABOUT HVPS and HV ELECTRONICS

Power Supply Use and Applications

INVERTER TOPOLOGIES

As mentioned above, there are a wide variety of Inverter topologies existing today. However, the choice of Inverter topologies for a high voltage power supply may be governed by two factors:

- Must isolate reflected parasitic capacitance
- Must be low noise

Luckily, there is one general approach which meets both requirements. This approach is resonant power conversion. Resonant topologies utilize a resonant tank circuit for the generation of the high frequency source. Figures 4 and 5 show two implementations of the resonant approach. Both successfully isolate the reflected capacitance by a series inductor. In some cases, the reflected capacitance (CR), and the series inductor (LR) comprise the tank circuit. This is known as a series resonant/parallel loaded topology. In other cases, a capacitor is connected in series with the inductor to form a series resonant/series loaded topology.

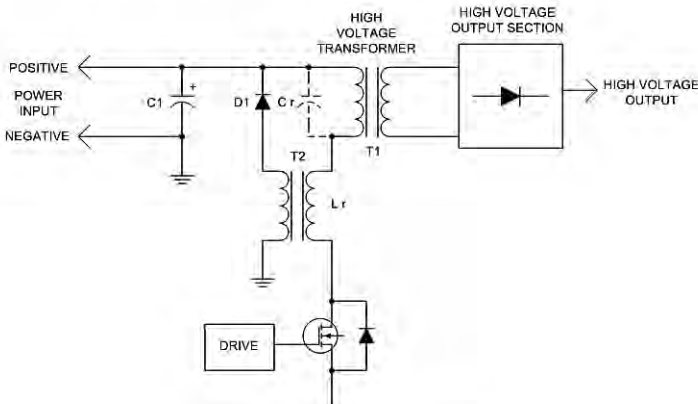

Fig. 4 Resonant Flyback/Forward Converter

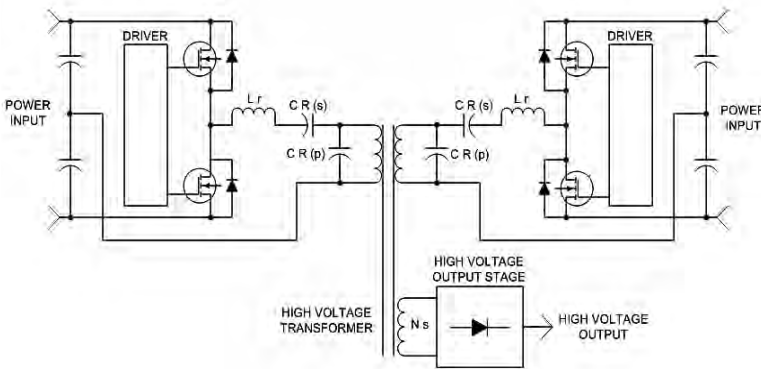

Fig. 5 Half Bridge/Full Bridge

The two approaches have two distinct differences. The parallel loaded topology more closely resembles a voltage source, while the series loaded topology resembles a current source. Each have advantages, but typically, the parallel loaded topology is used in low power applications, and the series loaded topology is used in high power operations. Many reasons exist for this differentiation of use with power level, but there are a few dictating reasons why each cannot be used in the others domain. To understand this we need to visualize the reflected capacitor and what happens to this capacitor during an output short circuit. This is of primary importance because under a short circuit condition the parasitic capacitance is reduced by the reflected secondary load, in this case zero ohms. In the low power application, the series inductor is of a relatively high impedance, (due to its VA requirements), and provides Vt/L current limiting for the inverter switching devices.

In the high power, the series inductor is of substantially lower impedance, and does not provide inherent current limiting. For this reason, a series loaded circuit is used. It can be seen by Figure 6, that a series loaded circuit, when operated outside its resonant tank frequency, resembles a current source inherently limiting the current capabilities and thereby protecting the switching devices. (Figure 6)

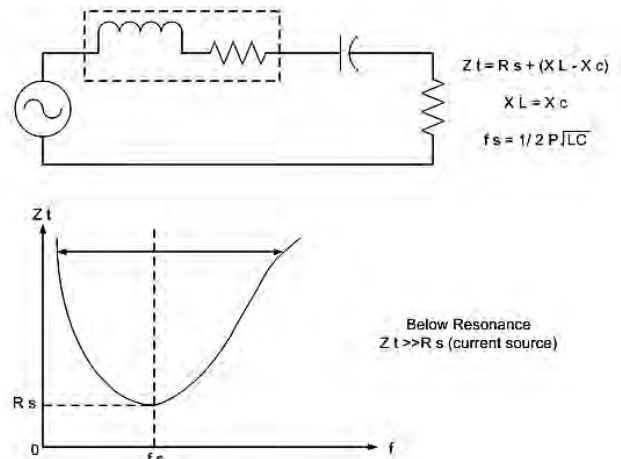

Fig. 6 Series Resonance

Still other reasons exist why a series loaded circuit cannot be used at low power. It can be seen that the series capacitor will support a voltage dictated by the Q of the resonant circuit and the applied voltage. In all cases, this voltage is seen across the total circuit capacitance, the series capacitor, and the parasitic capacitor. In the low power application the ratio of the series C to the parallel C is very high (again due to the VA requirements of the tank). This effectively creates a voltage divider, with most of the voltage appearing across the series C. This results in a significantly lower voltage applied to the transformer, thereby limiting high secondary voltages. If higher turns are added, more reflected capacitance is created and eventually no additional secondary volts can be generated.

TECHNICAL ARTICLES ABOUT HVPS and HV ELECTRONICS

Power Supply Use and Applications

OUTPUT STABILITY, REGULATION AND REPEATABILITY

As stated previously, the importance of consistent results is paramount in the analytical process. The high voltage power supply must be a source of stable and repeatable performance. Variations in the output voltage and current will usually have direct effects on the end results and therefore must be understood as a source of error. In high voltage power supplies, the voltage references that are used to program the desired output can be eliminated as a source of significant error by the use of highly stable voltage reference I.C.s. Typical specifications of better than 5ppm/°C are routine. Similarly, analog I.C.s (op amps, A/D, D/A's, etc.) can be eliminated as a significant source of error by careful selection of the devices. [1]

There remains one component, unique to high voltage power supplies, which will be the major source of stability errors: the high voltage feedback divider. As seen in Figure 2, the high voltage feedback divider consists of a resistive divider network. This network will divide the output voltage to a level low enough to be processed by the control circuits (i.e. <10vdc).

The problem of stability in this network results from the large resistance of the feedback resistors. Values of >100 megohms are common. (This is to reduce power dissipation in the circuit and reduce the effects of temperature change due to self heating). The large resistance and the high voltage rating requires unique technology specific to high voltage resistors. The unique high voltage resistor must be "paired" with a low value resistor to insure ratio tracking under changes of temperature, voltage, humidity and time.

In addition, the high value of resistance in the feedback network means a susceptibility to very low current interference. It can be seen that currents as low as 1×10^{-9} amps will result in >100ppm errors. Therefore, corona current effects must seriously be considered in the design of the resistor and the resistor feedback network. Also, since much of the resistor technology is based on a ceramic core or substrate, piezoelectric effects must also be considered. It can be demonstrated that vibrating a high voltage power supply during operation will impose a signal, related to the vibration frequency, on the output of the power supply.

AUXILIARY OUTPUTS

In many applications of high voltage, additional power sources are required for the instrument. In many cases, these auxiliary power sources work in conjunction with the high voltage power supply. Such examples are: Filament (heater) power supplies as found in every X-ray tube, bias (grid) control supplies, focus power supplies, and low voltage power requirements for other related control circuitry.

The instrument designer may choose to have one vendor provide all of the power supply requirements. This is very common in the high voltage area due to the expertise required when dealing with related high voltage circuits (i.e. filament isolation requirements). For the high voltage power supply designer this means an expertise in virtually all aspects of power conversion technology, not just high voltage power supplies. For example, it is not uncommon to find filament power supplies providing greater than 100 amps at 20 volts. In addition, this output circuitry may need isolation as high as 100,000 volts. Even motor control expertise is used in new high voltage technology.

CONCLUSION

This paper presented an overview of areas that are specific to the high voltage power supply. The high voltage power supply has unique concerns which differentiate it from standard off the shelf products. The designer, specifier and user of high voltage power must be aware of these concerns, in order to insure the best possible results. The technological advances in power conversion are occurring at such rapid rates that is it difficult for an instrument designer to undertake full responsibility of the high voltage power supply design. This responsibility, therefore, must be shared by the supplier of the high voltage power supply and the instrument designer.

As discussed in this paper, advanced power conversion technology, components, materials, and process are required for reliable high voltage design. In addition, safety aspects of high voltage use requires important attention. High voltage sources can be lethal. The novice user of high voltage should be educated on the dangers involved. A general guideline for safety practices is found in IEEE standard 510-1983 "Recommended Practices for Safety in High Voltage and High Power Testing [4]".

REFERENCES:

- 1.) Precision Monolithics Inc. (PMI), "Analog I.C. Data Book, vol. 10.
- 2.) D. Chambers and C. Scapellati, "How to Specify Today's High Voltage Power Supplies", Electronic Products Magazine, March 1994.
- 3.) D. Chambers and C. Scapellati, "New High Frequency, High Voltage Power Supplies for Microwave Heating Applications", Proceedings of the 29th Microwave Power Symposium, July 1994.
- 4.) IEEE Standard 510-1983, IEEE Recommended Practices for Safety on High voltage and High Power.

TECHNICAL ARTICLES ABOUT
HVPS and HV ELECTRONICS
Power Supply Use and Applications

High Voltage Power Supplies for Electrostatic Applications

by Cliff Scapellati

ABSTRACT

High voltage power supplies are a key component in electrostatic applications. A variety of industrial and scientific applications of high voltage power supplies are presented for the scientist, engineer, specifier and user of electrostatics. Industrial processes, for example, require significant monitoring of operational conditions in order to maximize product output, improve quality, and reduce cost. New advances in power supply technology provide higher levels of monitoring and process control. Scientific experiments can also be influenced by power supply effects. Contributing effects such as output accuracy, stability, ripple and regulation are discussed.

INTRODUCTION

The use of high voltage in scientific and industrial applications is commonplace. In particular, electrostatics can be utilized for a variety of effects. Broadly stated, electrostatics is the study of effects produced by electrical charges or fields. The applications of electrostatics can be used to generate motion of a material without physical contact, to separate materials down to the elemental level, to combine materials to form a homogeneous mixture and other practical and scientific uses. By definition, the ability of electrostatic effects to do work requires a difference in electrical potential between two or more materials. In most cases, the energy required to force a potential difference is derived from a high voltage source. This high voltage source can be a high voltage power supply. Today's high voltage power supplies are solid state, high frequency designs, which provide performance and control unattainable only a few years ago. Significant improvements in reliability, stability, control, size reductions, cost and safety have been achieved. By being made aware of these improvements, the user of high voltage power supplies for electrostatic applications can benefit. Additionally, unique requirements of high voltage power supplies should be understood as they can affect the equipment, experiments, process or product they are used in.

OPERATIONAL PRINCIPLES OF HV POWER SUPPLIES

The input voltage source may have a wide range of voltage characteristics. AC sources of 50Hz to 400Hz at less than 24V to 480V are common. DC sources ranging from 5V to 300V can also be found. It is critical for the user to understand the input voltage requirement as this will impact overall system use and design. Regulatory agencies

such as Underwriters Laboratory, Canadian Standards Association, IEC and others are highly involved with any circuits connected to the power grid. In addition to powering the main inverter circuits of the power supply, the input voltage source is also used to power auxiliary control circuits and other ancillary power requirements. The input filter stage provides conditioning of the input voltage source.

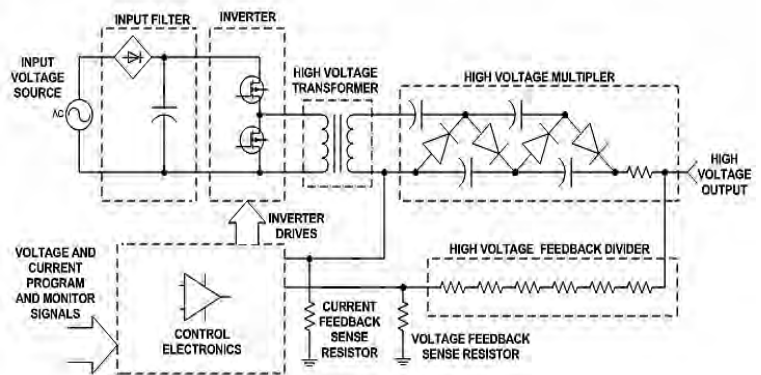

Fig. 1 Simplified Schematic Diagram of a High Voltage Power Supply

This conditioning is usually in the form of rectification and filtering in ac sources, and additional filtering in dc sources. Overload protection, EMI, EMC and monitoring circuits can also be found. The output of the input filter is typically a dc voltage source. This dc voltage provides the energy source for the inverter. The inverter stage converts the dc source to a high frequency ac signal. Many different inverter topologies exist for power supplies. The high voltage power supply has unique factors which may dictate the best inverter approach. The inverter generates a high frequency ac signal which is stepped up by the HV transformer. The reason for the high frequency generation is to provide high performance operation with reduced size of magnetics and ripple reduction storage capacitors. A problem is created when a transformer with a high step up ratio is coupled to a high frequency inverter. The high step up ratio reflects a parasitic capacitance across the primary of the high voltage transformer. This is reflected as a $(Nsec:Npri)^2$ function. This large parasitic capacitor which appears across the primary of the transformer must be isolated from the inverter switching devices. If not, abnormally high pulse currents will be present in the inverter.

Another parameter which is common to high voltage power supplies is a wide range of load operations. Due to the presence of high voltage, insulation breakdown is common-

TECHNICAL ARTICLES ABOUT HVPS and HV ELECTRONICS

Power Supply Use and Applications

place. The inverter robustness and control loop characteristics must account for virtually any combination of open circuit, short circuit and operating load conditions. These concerns as well as reliability and cost, must be addressed in the High Voltage Power Supply Inverter topology. The high frequency output of the inverter is applied to the primary of the high voltage step-up transformer. Proper high voltage transformer design requires extensive theoretical and practical engineering. Understanding of magnetics design must be applied along with material and process controls. Much of the specific expertise involves managing the high number of secondary turns, and the high secondary voltages. Due to these factors, core geometry, insulation methods and winding techniques are quite different than conventional transformer designs. Some areas of concern are: volts/turn ratings of the secondary wire, layer to layer insulating ratings, insulating material dissipation factor, winding geometry as it is concerned with parasitic secondary capacitance and leakage flux, impregnation of insulating varnish to winding layers, corona level and virtually all other conventional concerns such as thermal margins, and overall cost.

The high voltage multiplier circuits are responsible for rectification and multiplication of the high voltage transformer secondary voltage. These circuits use high voltage diodes and capacitors in a "charge pump" voltage doubler connection. As with the high voltage transformer, high voltage multiplier design requires specific expertise. In addition to rectification and multiplication, high voltage circuits are used in the filtering of the output voltage, and in the monitoring of voltage and current for control feedback. Output impedance may intentionally be added to protect against discharge currents from the power supply storage capacitors.

These high voltage components are typically insulated from ground level to prevent arc over. The insulation materials vary widely, but typical materials are: air, SF6, insulating oil, solid encapsulants (RTV, epoxy, etc.). The insulating material selection and process control may be the most important aspect of a reliable high voltage design.

Control circuits keep all of the power stages working together. Circuit complexity can range from one analog I.C. to a large number of I.C.s and even a microprocessor controlling and monitoring all aspects of the high voltage power. However, the basic requirement which every control circuit must meet is to precisely regulate the output voltage and current as load, input power, and command requirements dictate. This is best accomplished by a feedback control loop. Fig. 2 shows how feedback signals can be used to regulate the output of the power supply. Conventional regulation of voltage and current can be achieved by monitoring the output voltage and current

respectively. This is compared to a desired (reference) output signal. The difference (error) between the feedback and reference will cause a change in the inverter control device. This will then result in a change of power delivered to the output circuits.

In addition to the voltage and current regulation, other parameters can be precisely regulated. Controlling output power is easily accomplished by an $X \times Y = Z$ function, ($V \times I = W$), and comparing it to the desired output power reference. Indeed, any variable found within Ohm's law can be regulated, (resistance, voltage, current and power). In addition, end process parameters can be regulated if they are effected by the high voltage power supply (i.e. coatings, flow rates, etc.).

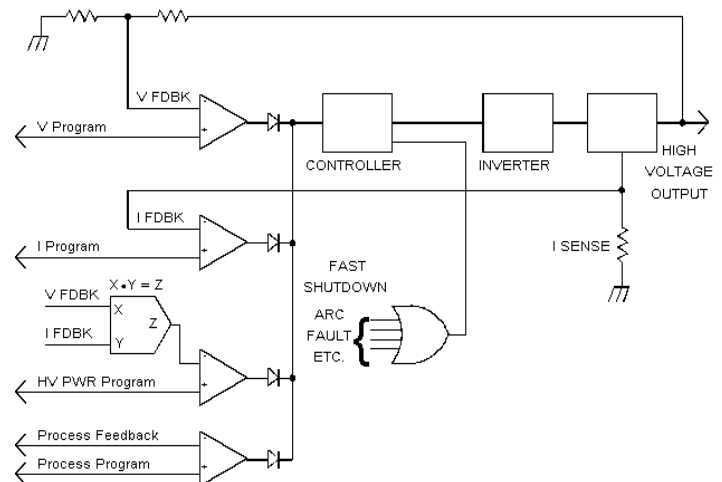

Fig. 2 Power Supply Control Loops

HIGH VOLTAGE REGULATION

The importance of a regulated source of high voltage and/or constant current is critical to most applications involving electrostatics. Variations in output voltage or current can have direct effects on the end results and, therefore, must be understood as a source of error. In high voltage power supplies, the voltage references that are used to program the desired output can be eliminated as a source of significant error by the use of highly stable voltage reference I.C.s. Typical specifications of better than 5ppm/°C are routine. Similarly, analog I.C.s (op amps, A/D D/A's, etc.) can be eliminated as a significant source of error by careful selection of the devices.

There remains one component, unique to high voltage power supplies, which will be the major source of stability errors: the high voltage feedback divider. As seen in Fig. 1, the high voltage feedback divider consists of a resistive divider network. This network will divide the output voltage

TECHNICAL ARTICLES ABOUT HVPS and HV ELECTRONICS

Power Supply Use and Applications

to a level low enough to be processed by the control circuits. The problem of stability in this network results from the large resistance of the feedback resistors. Values of >100 megOhms are common. (This is to reduce power dissipation in the circuit and reduce the effects of temperature change due to self heating). The large resistance and the high voltage rating requires unique technology specific to high voltage resistors. The unique high voltage resistor must be "paired" with a low value resistor to insure ratio tracking under changes of temperature, voltage, humidity and time.

In addition, the high value of resistance in the feedback network means a susceptibility to very low current interference. It can be seen that currents as low as 1×10^{-9} amps will result in >100ppm errors. Therefore, corona current effects must seriously be considered in the design of the resistor and the resistor feedback network. Also, since much of the resistor technology is based on a ceramic core or substrate, piezoelectric effects must also be considered. It can be demonstrated that vibrating a high voltage power supply during operation will impose a signal, related to the vibration frequency, on the output of the power supply.

AUXILIARY FUNCTIONS FOR THE HV POWER SUPPLY

In many applications of high voltage, additional control functions may be required for the instrument. The power supply designer must be as familiar with the electrostatics application as the end user. By understanding the application, the power supply designer can incorporate important functions to benefit the end process.

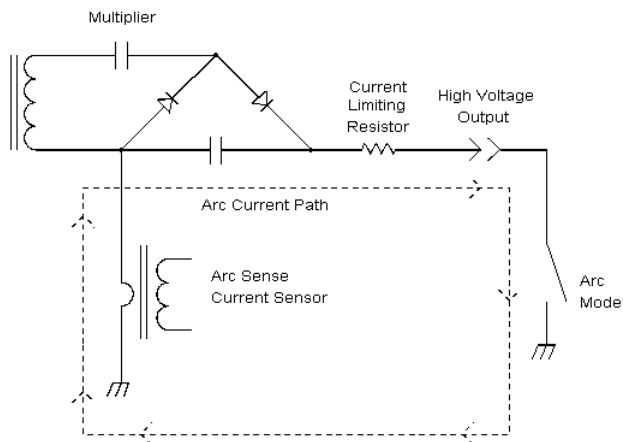

Fig. 3 Arc Sense Circuit

A typical feature that can be implemented into a high voltage power supply is an "ARC Sense" control. Fig. 3 shows a schematic diagram of an arc sense circuit. Typically, a current sensing device such as a current transformer or resistor is inserted in the "low voltage side" of the high voltage output circuits.

Typically, the arc currents are equal to:

$$I = (E/R) (1)$$

where I = Arc current in amperes.

E = Voltage present at high voltage capacitor.

R = Output limiting resistor in ohms.

The arc current is usually much greater than the normal dc current rating of the power supply. This is due to keeping the limiting resistance to a minimum, and thereby the power dissipation to a minimum. Once the arc event is sensed, a number of functions can be implemented. "Arc Quench" is a term which defines the characteristic of an arc to terminate when the applied voltage is removed. Fig. 4 shown a block diagram of an arc quench feature.

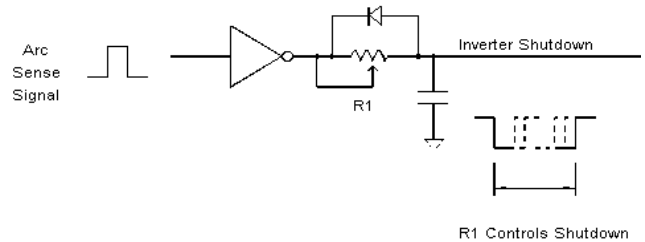

Fig. 4 Arc Quench

If shutdown is not desired on the first arc event, a digital counter can be added as shown in Fig. 5. Shutdown or quench will occur after a predetermined number of arcs have been sensed. A reset time must be used so low frequency arc events are not accumulated in the counter. Example: A specification may define an arc shutdown if eight arcs are sensed within a one minute interval.

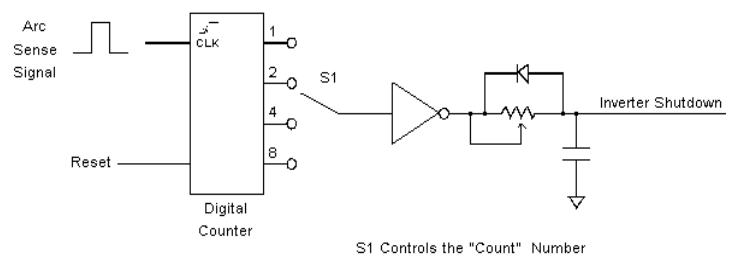

Fig. 5 Arc Count

TECHNICAL ARTICLES ABOUT HVPS and HV ELECTRONICS

Power Supply Use and Applications

A useful application of the arc sense circuit is to maximize the applied voltage, just below the arcing level. This can be accomplished by sensing that an arc has occurred and lowering the voltage a small fraction until arcing ceases. Voltage can be increased automatically at a slow rate. (Fig. 6).

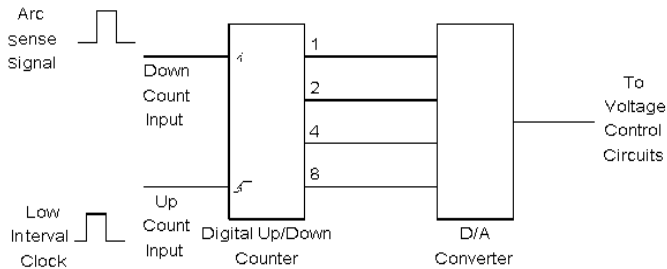

Fig. 6 Automatic Voltage Reduction Circuit

Another feature which can be found in the high voltage power supply is a highly accurate current monitor circuit. For generic applications this monitor feature may only be accurate to milliamperes, or microamperes. However, in some electrostatic applications accuracy down to femtoamperes may be required. This accuracy can be provided by the high voltage monitoring circuits. However, the user of the power supply usually must specify this requirement before ordering.

GENERATING CONSTANT CURRENT SOURCES

In many electrostatic applications, a constant current created by corona effects is desirable. This can be accomplished in a number of unique ways. A constant current source can be broadly defined as having a source impedance much larger than the load impedance it is supplying. Schematically it can be shown as in Fig. 7:

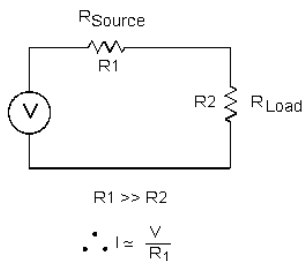

Fig. 7 Practical Current Source

Practically stated, as R2 changes impedance there is negligible effect on the current through R1. Therefore, R1 and R2 have a constant current. In a single power supply application, this can be accomplished two ways. The first is to provide an external resistor as the current regulating device. The second is to electronically regulate the current using the current feedback control as shown in Fig. 2. In applications where multiple current sources are required, it may not be practical to have multiple power supplies. In this case, multiple resistors can be used to provide an array of current sources. This is typically used where large areas need to be processed with the use of electrostatics. Fig. 8 shows this scheme.

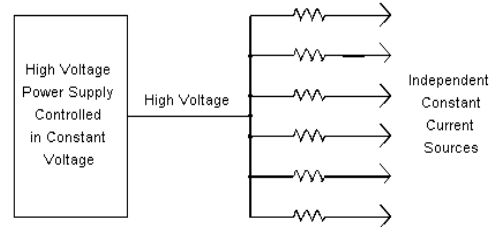

Fig. 8 Simple Multiple Current Sources

CONCLUSION

This paper presented information useful to electrostatic applications using high voltage power supplies. The high voltage power supply has concerns which differentiate it from conventional power supplies. The designer of high voltage power supplies can be a key resource for the user of electrostatics. Significant control features can be offered by the high voltage power supply. In addition, safety aspects of high voltage use requires important attention. High voltage sources can be lethal. The novice user of high voltage should be educated on the dangers involved. A general guideline for safety practices is found in IEEE standard 510-1983 "Recommended Practices for Safety in High Voltages and High Power Testing [4]".

REFERENCES:

- 1.) C. Scapellati, "High Voltage Power Supplies for Analytical Instrumentation", Pittsburgh Conference, March 1995.
- 2.) D. Chambers and C. Scapellati, "How to Specify Today's High Voltage Power Supplies", Electronic Products Magazine, March 1994.
- 3.) D. Chambers and C. Scapellati, "New High Frequency, High Voltage Power Supplies for Microwave Heating Applications", Proceedings of the 29th Microwave Power Symposium, July 1994.
- 4.) IEEE Standard 510-1983, IEEE Recommended Practices for Safety In High Voltage and High Power Testing.

A Product Development Process for High Voltage Power Supplies

by Cliff Scapellati

ABSTRACT

Applications requiring high voltage power sources are growing at a healthy rate. In most cases the high voltage power supply must be custom designed for a particular application. In addition, market pressure for reduced cost, increased power, and higher reliability require significant research for new, innovative approaches.

The intent of the paper is to familiarize the user and specifier of high voltage power supplies to the development process, thereby improving future development programs. A typical development time for these new designs will be less than one year. An analysis of this development process is discussed. The development process must include: specification of the product, material and labor cost goals, vendor and component issues, process control analysis, electrical/mechanical/material engineering, definition of experiments, stress testing, safety analysis, regulatory requirements, prototype construction and testing, production documentation, design review milestones, and production start up. These requirements are presented with real world applications involving high voltage insulation systems, packaging concepts, high voltage testing, and electronic designs.

INTRODUCTION

The foundation of any specific product development process is its ability to apply the general methods of project management. Project management tools will allow the successful execution of the process. In general, project management will coordinate all resources required to define, plan, execute, and evaluate the project. The decision to undertake a project may be complex. However, once the decision is made to move forward on a project, the decision to apply methods of project management is easy. By definition, a project signifies that important strategic goals are at stake. Without proper project management the goals will not be achieved.

In the area of high voltage power supply product development, a rigorous and detailed process has been defined and executed with a high success rate. Many areas of work, experimentation, and testing have been proceduralized specifically for high voltage.

PRODUCT DEFINITION AND CONCEPTUALIZATION

Typically, high voltage power supplies are specified by the next level system designer. Rarely are marketing specifications the basis of the product definition. This greatly simplifies the task of finalizing specifications and getting approval to start the project.

The next level system can be defined as the equipment the high voltage power supply will be used in. The system design team will be required to work closely with the engineers designing the high voltage power supply. In most cases, technical discussions can yield a sufficient specification in a matter of days. Other contract issues may cause delayed start to projects and need to be given proper attention.

A. Product Conceptualization:

In parallel with the technical and specification discussion, a conceptual approach will take form. Initially, relying on existing platform technologies is the best method to reduce risks. Risk reduction analysis at this phase can save significant cost and time further into the project. Risk analysis needs to be considered for the benefit of both parties. Neither party will benefit by unwarranted and unnecessary risks. However, it requires great discipline to overcome the lure of conceptualizing an approach that may seem novel and exciting. Many engineers will fail this test and may pay a price by having program delays, reliability problems and cost overruns. Of course basic research and development cannot be sacrificed and must be carried out separately from the development efforts. The product development process can be crippled if new R&D needs to be accomplished during its phase.

B. The Iterative Design Process:

As stated above, using an existing platform product is the best way to minimize risks. However, even with platform products, some new design concepts will be needed. These will typically involve: new mechanical packaging, new interface circuitry, auxiliary power requirements (filament or grid supplies), etc. Initially, these new ideas will be the starting point for design details. However, if not continuously updated, these "first approach" ideas will invariably not yield the best solution.

Simply Stated: Never go with your first idea. It will become outdated quickly once the conceptual design starts to take form. The technique which is best used during these early phases is an iterative design

TECHNICAL ARTICLES ABOUT HVPS and HV ELECTRONICS

Power Supply Use and Applications

process. Whereby initial concepts are continuously updated as the details take form. From an outside vantage point, the iterations may seem to cause project delays. But in the long run, this process will result in a more solid foundation to insure the strength of the project in its final phases.

At every critical iteration, the user or specifier must participate in the design change. This further insures the validation of the product.

PROJECT PLANNING

Clearly defining the scope of a project is as important as the conceptualization and design of the product. Without a clear understanding of the "who, what, where, when, why, and how", a project can go off course. This can basically be seen as the business side of the project management. "Business" can be seen as a taboo subject to some technical people. This is perfectly understandable and needs to be factored into the decision making process used by the technical design team. Here, the project manager must have full understanding of the strategic business goals associated with the success of the project. The project manager must continually weigh business issues with technical issues. Difficult judgments and decisions will have to be made. It is here that the defined scope of the program will help guide in decision making. In all cases, the project manager must attempt to impart the business strategy and scope to all team members. In many cases, this will allow "buy in" when judgments are made, or a strategic course change is required. In some cases, team members will not relate to the business strategy and scope of the project. This is natural and must be managed.

A. The Work Breakdown Structure:

The work breakdown structure (WBS) is a concept routinely used in classical project management. The WBS clearly defines, in a hierarchal manner, the work to be performed. In larger projects, the details of work may not find their way into a formal WBS analysis. However, in small to moderate sized projects, (such as the development of a high voltage power supply), all WBS details should be made visible. In larger projects the WBS tasks may be assigned to groups or departments, but in the small to moderate sized projects, tasks should always be clearly assigned to an individual. Examples of this type of detail would be: printed wiring board design, magnetics design, experimental definitions and analysis, parts list creation, etc.

An example of a WBS for a printed wiring board is shown:

1.0 CONTROL PWB DESIGN

1.1 Electrical Design

1.1.1 Controller EE

1.1.2 Diagnostics

1.1.3 Interface

1.2 PWB Layout Design

1.2.1 Mechanical Area Study

1.2.2 Component Symbols Created

1.2.3 Routing Etc.

Based on the WBS outline, the individual or group can now pursue their assigned task by organizing the time and resources required for completion.

B. Resource Allocation:

It is a requirement of the development process that qualified resources be assigned. Invariably, the quantity and capabilities of the team members will determine the success or failure of the project. Insufficient resources, or the unavailability of assigned resources will result in the delayed completion of WBS tasks. Even if sufficient resources are available, capability limits of the individual may also delay task completion. When assigning resources to tasks, it is critical to specify the project and task goals. They must be specifically defined, assigned clearly to an individual who will be responsible, and with a time base for completion. Other influencing factors may effect resources and cause delays. Outside services such as consultants, subcontractors, or vendors can seriously hamper progress if their performance is not acceptable. When individuals are responsible for multiple products or projects, unexpected conflicts will occur. For example, a product that has completed its development phases suddenly requires a redesign or changes. This type of unexpected resource loading is typical, but very difficult to manage. Whenever possible, product support engineers should be used to support non-development activities.

C. Project Schedules:

The project schedule is another critical tool for managing the project. A number of project scheduling systems can be used.(1) In this specific process, a project master schedule is implemented using a project planning bar chart or GANTT chart. Here tasks are indicated in order with a sequential time base. The order of the tasks can follow the WBS. This helps to keep the WBS

TECHNICAL ARTICLES ABOUT HVPS and HV ELECTRONICS

Power Supply Use and Applications

and schedule in one data base for easier management. Once again, as in the case of the WBS, it is important to include as many detailed tasks as practical into the project schedule. Otherwise, these tasks can easily be forgotten. Examples of these types of tasks are:

- Design Review Milestones and Preparation
- Material and Cost Tracking
- Material Ordering
- Process Documentation
- Shipping Packaging Design
- Test Equipment and Procedures
- ESS Testing
- Manufacturing Tooling
- Manufacturing Drawings Release
- Etc.

When creating the project schedule it is important to have the project team understand and agree on the time allocations assigned to a task. If the time estimates are not credible, the team members may reject ownership and the task will not be completed. In addition to the team members, senior management should be informed, and individual projects should be loaded into a long term department master schedule.

DESIGN REVIEW GUIDELINES

The design review forum is a critical part of a project. During these forums, a project review is undertaken in order to inform concerned parties, who are not directly associated with the project team, on the progress of the project. It is important that these design reviews reinforce and amend the progress of the team. In no way can the design review replace daily and weekly project management. By their nature, design reviews occur only at critical phases of a project. Project delays will occur if important decisions are delayed until the design review milestones. A successful technique used for short term review is weekly team meetings. In this forum, the critical team members meet weekly and resolve issues quickly. This group is typically 8-12 people and consist of: project manager, electrical engineers, mechanical engineers, lab personnel, quality control, sales/marketing, and representatives from manufacturing departments.

In the process used for the high voltage power supply development, specific requirements for each design review are required and a checklist is used to insure completion of these requirements. Important design reviews milestones are defined and it is very useful when the end user of the equipment attends design reviews. These milestones occur at the following phases of the project:

A. Conceptual Design Review:

The conceptual design review occurs early in the project. At this stage, product concepts are reviewed along with the specification requirements.

Some of the specific requirements of the conceptual design review are:

- Design Compatibility with Specifications
- Mechanical Design Concepts
- Mechanical Outline Drawings
- Electrical Design Concepts
- Heat Dissipation Concepts
- Software/Hardware Architecture
- Reliability and Environmental Stress Screening (ESS)
- Manufacturability
- Technical and Cost Risks
- Testing and Maintenance
- Program Schedule
- Material and Labor Cost Estimates

Each of these are discussed and reviewed. Inevitably, new tasks are required as questions are raised. These tasks are tracked as "Action Items", and are assigned to an individual along with a completion date. All action items are reviewed at the weekly meetings. This helps to insure prompt attention to these tasks.

B. Critical Design Review:

The critical design review occurs mid-way in the project. Here, detailed design data, experimental data, and breadboard hardware review takes place. Many topics covered in the conceptual design review will be reviewed again. However, at this phase the level of detail should be such as to clearly define and identify the product. These details can be described as:

- Preliminary Performance Data (to the specification)
- Mechanical Design Detailed Drawings
- Electrical Schematics
- Heat Dissipation and Efficiency Data
- Software Specifications
- ESS Test Plan
- Engineering Acceptance Test Procedure (ATP)
- EMC Test Plan
- Breadboard Demonstration
- Actual Material Costs and Project Expenditures

Once again, action items are assigned. Previous action items from previous design reviews are discussed and hopefully all issues resolved.

C. Final Design Review:

At this point in the project, verification of the product is reviewed. A completed acceptance test procedure is made available and any open performance or reliability issues are discussed. As before, items from previous design reviews are discussed and hard evidence of completion is presented.

ISO9000 STANDARDS

The process for high voltage power supply design described here operates under the umbrella of the ISO9000 quality system. Specifically, this process was required to be proceduralized to sections 4.3, Contract Review, 4.4, Design Control, and 4.5, Documentation and Data Control, of the ISO9001 International Standard.

It can be demonstrated that all parts of the development process address the ISO standards. Contract review is established early on during the technical specification and project conceptualization phase. Since the high voltage power supply has been defined as a customer driven requirement, the customer is involved in all aspects of the initial review. Changes throughout the product life impact the customer and supplier manage the changes.

Design control adherence will naturally occur if the project planning, design review, and resource allocation are followed and properly documented.

Design verification and design validation requires special attention. Many items covered in the design reviews will document the design verification. Design validation can be accomplished by in house testing to recreate the end user's conditions, or by receiving successful detailed test reports from the end user. Although documentation and data control may not directly be required during a product development project, important critical documents are created and need to be controlled early on in the project. This will minimize uncertainty when the product release to manufacturing is done.

Next Generation in Power Feed Equipment

by Paul Treglia and Clive McNamara

Background

A submarine cable system is fed power from Power Feed Equipment (PFE). The PFE supplies constant current to the fiber optic repeaters. There are longstanding, historical requirements for PFE including; stable output (constant current), high reliability (even through an earthquake), safety, and high levels of control/diagnostics provided. In the years of “recovery” after 2002, there were other requirements added; low-cost, and less complexity (smaller footprint). Fast forward to 2006 where the first Spellman-designed, Single-Bay complete PFE (Gen 3) started shipping out to sites.

The need for more

The Gen 3 system is rated for 5kV, which limits the length of cable that can be powered. It is not suitable for longer cable runs (>2000km). Increasing needs for long cable runs drives the voltage requirement higher, and advancements in repeater design drive the current higher. The higher current for the repeaters then increases the PFE voltage requirement even further because this increases the cable losses (voltage drop). Based on those needs, the next generation of PFE, Gen 4, was designed to provide higher voltage, higher current and higher power for long-haul systems.

Gen 4 PFE



Fig. 1 GEN 4 PFE

The Gen 4 PFE has a nominal rating of 15kV, 1.5A. This is a substantial increase in voltage (3x), current (1.5x) and power (4.5x) as compared to Gen 3. The Gen 4 PFE is a 3-cabinet design. The 3 cabinets (from left to right) are as follows:

PFE Output/Control Bay

Contains the Local Control Unit (LCU) and Network Switch Unit (NSU) which work together to unify the Ethernet communications amongst all the internal elements of the PFE, as well as externally, to a Network Management System for remote diagnostics and monitoring. Also within this bay are the sophisticated PFE specific functions for output monitoring, protection, configuration, and polarity setting.

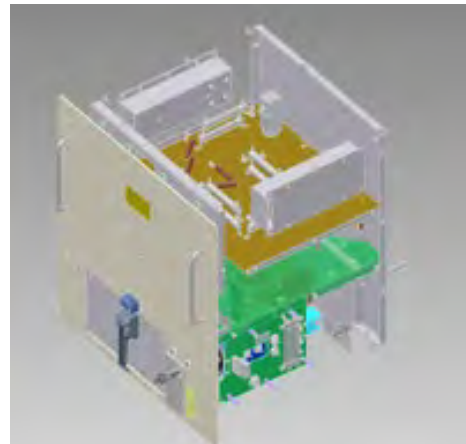

Fig. 2 Output Monitor Unit (OMU).
Part of PFE Output/Control Bay

Converter Bay

Contains 6 identical High Voltage Power Converters in an n+1 configuration. Only 5 Converters are needed for full voltage/current. If less than that is required, less converters are needed to satisfy the requirements.

Test Load Bay

Contains a mixture of 1 Active Test Load (ATL) module and 4 Passive Test Load (PTL) modules.

TECHNICAL ARTICLES ABOUT HVPS and HV ELECTRONICS

Power Supply Use and Applications

The ATL is a variable electronic load utilizing an array of MOSFET transistors operated in their active region. The PTL is comprised of fixed resistors, combined with high voltage relays. The ATL provides the fine control and the PTL provides the coarse control. These modules work together to provide a variable load capable of dissipating 22.5kW continuously.

Fig. 3
Passive Test Load (PTL)

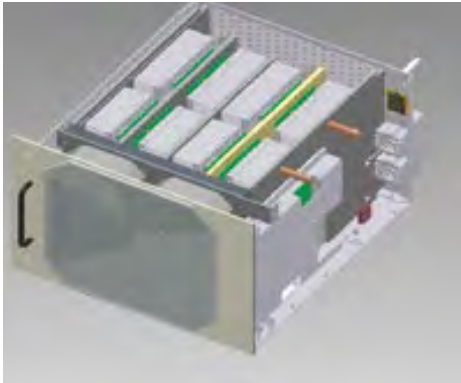

Fig. 4
Active Test Load (ATL)

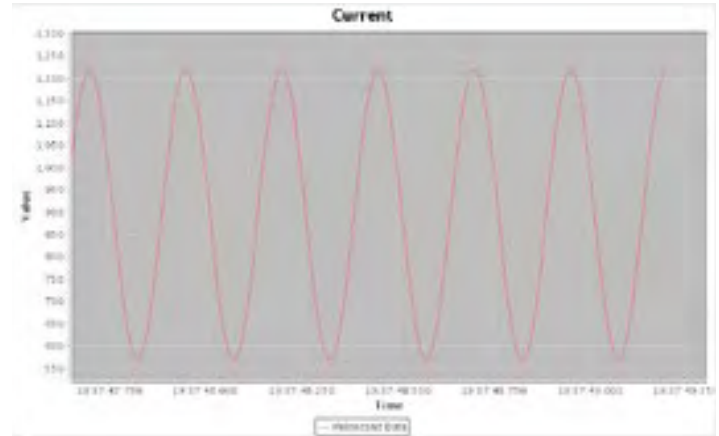
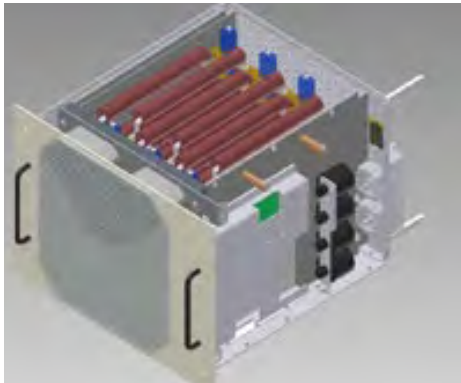

Fig. 5 LCU Data Acquisition Graphical Interface

Redundant Ocean Ground connections

More and more customers are requesting this option. It allows redundancy in the critical connection to Ocean Ground (OG). The current is monitored in both OG connections. Normally, those currents should be equal. If they aren't, it likely indicates a connection issue on one of them, which alerts the user that service is required before it affects operation of the PFE.

Configurable for multiple voltage ranges

The Gen 4 PFE has a maximum voltage of 15kV, but it can be configured (at the factory) for lower voltage, while keeping the same current rating (1.5A). Options of 6kV, 9kV, 12kV, in addition to 15kV are available. This is accommodated simply by installing less Converter and Passive Test Load (PTL) modules (1 converter and 1 PTL less for each 3kV reduction). The system always contains 3 cabinets. Covering from 6-15kV picks up nicely from where the Gen 3 PFE leaves off (at 5kV).

Similar to the Gen 3 PFE, most of the Field Replaceable Units (FRU) within the PFE are blind-mating which allows quick replacement in case of failure.

Additional features

During the design process, it is often the time to consider additional features based on customer requests in previous versions. Below are some features added during the Gen 4 PFE design. These features are not available in the Gen 3 PFE:

Data Acquisition

The Gen 4 PFE is constantly recording critical parameters; PFE Voltage, PFE Current, Ocean Ground Voltage, Station Ground Current, every 10ms. The LCU integrated within the PFE has the ability to plot this data locally or it can be sent upstream (externally) to the Network Management system. The internal memory within the PFE allows a rolling queue of about 1 week of data.

Gen 3 to Gen 4 PFE Comparison

	Gen3	Gen4
# of cabinets	1	3
Converter Redundancy	2n	n + 1
Voltage	5kV	15kV
Current	1.0A	1.5A
Power	5kW	22.5kW
Data Acquisition	No	Yes

Gen 3 PFE

The Gen 3 PFE was designed to accommodate shorter cable runs at a lower price, while still achieving high levels of safety, diagnostics, reliability and availability. To date, over 65 Gen 3 PFE systems are in service, providing reliable power to fiber optic repeaters all over the globe.

TECHNICAL ARTICLES ABOUT HVPS and HV ELECTRONICS

Power Supply Use and Applications

The Gen 3 PFE has nominal ratings of 5kV and 1A. This is adequate for +1000km cable installations and many times is used to power cables that hop across several landing sites across the shores of neighboring countries.



Fig. 6 GEN 3 PFE

Starting at the top, we have:

Test Load

Variable Electronic Load, capable of dissipating 5kW continuously.

Converters (2)

2n configuration, where each converter can run at 5kV, 1A in case the other one fails. During normal operation, the converters are in series and share the total PFE voltage.

Local Control Unit (LCU)

PC, Keyboard, Monitor, Mouse, Ethernet switch.

PFE Output Module

The output of the Converters power the submarine cable via sophisticated monitoring and protection devices. Cable access and termination (shorting or opening) is also being provided at the PFE output point. This access point can be used to insert other ancillary cable testing devices into the cable path. Due to the dangers of High Voltage being present, significant safety features need to be incorporated at this point, and throughout the PFE.

PFE for Cable Laying Ships

In addition to advancements in landbased PFE, there also have been some advances in ship-based PFE. The cable-laying by ships is a costly and time consuming process in the deployment of a new or repaired cable and as such it is important that the ship's cable engineers know that the cable they are laying is operating correctly. This could be powered from the land base PFE at the landing station, but this would be a very hazardous for the crew on the ship for the repair as the control of when the HV is on or off is not on the ship where the cable engineers and handlers could be exposed to the HV on the cable being deployed.

Ship board PFE is used to power the cable during these operations whilst keeping the control of the HV at the ship so the safety of the crew can be maintained. Due to the fact cable laying ships can work on many difference cables the Ship Board PFE is typically capable of around 12kV at around 2A.



Fig. 7 Ship Board PFE

These shipboard PFE systems are functionally very similar to standard land based PFE, only with reduced functionality and requirements, (and a substantially lower price). Part of the similarity is the control for powering the cable up and down. The cable is an enormous inductor and capacitor it needs to have the current changes controlled very slowly so as not to cause any transients or oscillations that could damage the repeaters.

TECHNICAL ARTICLES ABOUT HVPS and HV ELECTRONICS

Power Supply Use and Applications



Fig. 8 Workers prepare for Cable laying
Courtesy of Global Marine Systems, Ltd.

Conclusion

Highly advanced PFE solutions have been designed and deployed and have proved to meet and even exceed customer requirements and expectations. With the Gen 3 and Gen 4 PFE systems, most, if not all, land-based needs are met for powering Subsea Fiber Optic communications around the globe. Future advancements and solutions are in the works, which have the possibility of providing significantly smaller systems with higher voltage capabilities, as well as low-cost, lower-voltage units (e.g. for branching power requirements).

Paul Treglia is Director of Product Development, Spellman High Voltage Electronics Corporation

Clive McNamara is UK Regional Sales Manager, Spellman High Voltage Electronics, Ltd.

The Ship Board PFE has a new System Management Terminal (SMT) that allows the parameters needed to be set and the alarms and ramp rates for powering up and down to be controlled safely. The SMT replaces the original System Control Unit (SCU) which is now obsolete.



Fig. 9 Ship Board SMT

The Ship Board PFE can operate from the AC supplied from ship generators, and generally can use more “Off the Shelf” High Voltage power supply units. (No need to carry all those batteries on board and hopefully no seismic events while out at sea). But reliability is still paramount for the shipboard PFE, as a PFE failure out at sea would stop cable deployment until help arrives.

High Voltage Power Supply Technology for Use in Power Feed Applications

by Paul Treglia and Clive McNamara

Background

The general technology area involving power supplies can be termed Power Conversion Technology. Within power conversion technology, there are many types of power supplies and devices for many varied applications. High Voltage power supplies are one of many niche markets existing in this broad technology area. Power Feed Equipment (PFE) is an even smaller niche within High Voltage power conversion technologies. For this reason, and others, PFE has traditionally been designed and manufactured by the captive manufacturers of undersea cable systems. Historically, this strategy was driven by the critical application knowledge required to design PFE, and the absence of this knowledge in the broader High Voltage power supply technology sectors. However, with power conversion technology advancing at a rapid rate, it is difficult for a systems manufacturer to devote the resources required to keep current on these advances.



Outsourcing Model Advances PFE Technology

In the early 1990's the strategy of outsourcing "non-core technologies" started to take off. Many large companies doing complex systems outsourced subsystem components to companies specializing in the applicable technology. This strategy was adopted back then by AT&T (now Tyco Telecommunications) for a new low-cost PFE project. By partnering with a manufacturer dedicated to High Voltage power supply manufacturing, paired with AT&T's application knowledge, unique solutions were implemented for PFE requirements. (Figure 1 shows a converter sub-system developed for AT&T in the early 90's). To date, this type of partnership is leading the way for future advances in PFE technologies. Key benefits are in the areas of smaller size, lower price, lower cost of ownership, and higher system reliability.

High Voltage Technology Basics

Let's start off with a Warning: The High Voltage potential used in any PFE is Lethal! Only qualified operators and service personnel should be using or accessing any High Voltage equipment.



Fig. 1

The High Voltage power supply as used in the PFE is often termed the Converter. Accurately so, because it converts one form of DC (-48 volts) to another form of DC (High Voltage DC). Within the converter there are a few basic building blocks:

Input Power processing

Provides input power filtering and circuit protection. Often in Telecom applications dual-input battery power sources (BAT A and BAT B) are used. This provides redundant input power sources for each device.

Inverter

Within any modern Converter is an Inverter. An Inverter "inverts" the DC power source to a high frequency ac power source. This allows for compact magnetic assemblies and high performance features such as ultra-low output ripple and fast output regulation response. The inverter uses high-speed transistors to "switch" the DC into an ac signal. (Since Telecom power supplies are usually powered from 48 volts, MOSFET's are the best transistor technology to use).

High Voltage step-up Transformer

The high frequency ac power source is connected to a transformer with a high step-up ratio. In PF applications, the transformer secondary winding needs to be isolated to voltages up to and greater than the output voltage rating of the PFE (typically 2x, to ensure high reliability).

TECHNICAL ARTICLES ABOUT HVPS and HV ELECTRONICS

Power Supply Use and Applications

Output rectifier

Since the application requires a DC source, yes, we need to invert that AC back into DC again. This is accomplished by high speed, high voltage rectifier diodes. (These multiple stages of inversion may seem like a silly process to someone outside the power supply field, but it is the best way to achieve the end goal).

Control

All of the building blocks of the Converter are monitored and controlled by control circuit electronics. In modern Converters, these circuits utilize advanced Digital Signal Processors (DSP) and Field Programmable Gate Arrays (FPGA). In PFE applications, the control circuits communicate to the PFE system controller for all control and monitoring.

The Converter is packaged into an easy to replace blind-mating unit known as a FRU, (Field Replaceable Unit). Most of the FRU's within the PFE are blindmating which allows quick replacement in case of failure.

For PFE applications, multiple converters are often used to provide modularity to suit a variety of output voltage configurations, and for redundancy in the case of any individual converter going off-line.

PFE's Unique Requirements

In practice, the Converter is actually the most conventional component within the PFE. (Hence it makes sense that the converter portion of the PFE was the first part of the PFE system to be outsourced). In addition to the Converter, PFE has many other functional building blocks:

Safety

Although somewhat an intangible item, Safety is the major building block consideration when designing the PFE. Because the cable can be powered from either end, (a term known as Double-end Feeding), there exists the possibility of High Voltage being present even if the local PFE is turned off. Significant safety systems are deployed in PFE. These typically involve high-level, redundant monitors, Fail-safe switching devices, protection barriers, key-lock interlocks and access systems.

Reliability

Since downtime is so costly, high reliability in Telecom equipment is mandatory and PFE is no exception. High reliability in the PFE is achieved via a combination of redundancy, high derating, and increased clearance spacing of all critical components. The margins are tested with a rigorous validation test plan to ensure the design performs as expected under all worst-case

conditions in the field. Low Corona is also required in all High Voltage assemblies within the PFE and must be tested on every assembly built. Providing High Voltage assemblies with Low Corona is a daunting task. It is achieved by very specialized techniques utilized within the High Voltage Industry.

DC Distribution and Monitoring

Provides circuit breaker protection for each FRU and DC power distribution for the entire PFE.

PFE Local Controller

Provides Local control and monitoring of the PFE via a Graphical User Interface (GUI). The Local Controller typically consists of an industrial PC (server), a multi-channel Ethernet switch connecting all other modules within the PFE together, a keyboard, mouse, and LCD display and/or touch-screen. The Local Controller directly communicates with the cable station's network management system for monitoring and limit control of the PFE. (For safety reasons, often controlling the PFE settings remotely is not done. However, modern PFE's can offer unique remote control features that facilitate remote diagnosis of PFE or cable problems).

Cable Monitoring and Access



Fig. 2

The output of the Converters power the submarine cable via sophisticated monitoring and protection devices. Cable access and termination (shorting or opening) is also being provided at the PFE output point. This access point can be used to insert other ancillary cable testing devices into the cable path. Due to the dangers of High Voltage being present, significant safety features need to be incorporated at this point, and throughout the PFE. Figure 2 shows a PFE Cable monitoring FRU, with Cable access and terminating mechanisms.

TECHNICAL ARTICLES ABOUT HVPS and HV ELECTRONICS

Power Supply Use and Applications

Test Load

The Test Load unit allows testing of a Converter within the PFE cabinet while the Cable remains powered by the redundant Converters. Or similarly, both converters can be tested on the Test Load. The Test Load is a unique concept in deployed High Voltage systems, found only in PFE's. Traditionally, the Test Load was configured from an array of passive, fixed resistors. In order to change the load settings, high voltage relays were employed to select and reconfigure the fixed resistors. Nowadays, electronic test loads are available.



Fig. 3

These test loads use an array of active MOSFET transistors. The transistors can be programmed to offer an infinite range of load configurations within the PFE's capabilities. In addition, highly compact Test Loads can be achieved. These modern Test Loads do come at a premium price though. However, their small size can offer a massive reduction in the size of the cabinets used for just the Test Load. Indeed, modern PFE's can be realized within a single cabinet, including the Test Load!

Figure 3 shows a modern 5kW Electronic Test Load, along with Figure 4, one of its MOSFET card arrays.



Fig. 4

The Cabinet

Often referred to as "The Bay", a PFE cabinet has some conventional, as well as unique features. The complete PFE needs to meet seismic requirements per GR-63-CORE. The cabinet design is a critical factor in meeting this requirement. Due to the custom nature of the PFE hardware, the cabinet too is a custom design. Safety interlocks and High Voltage cable routings need custom solutions. Modern single-bay PFE's incorpo-

rate unique "Trap Door" mechanisms that allow removal of the FRU's while High Voltage is present. The trap doors provide spring-loaded barrier protection so that live circuits cannot be touched if modules are removed. Figure 5 shows the innards of a PFE cabinet. Virtually all of the mechanics need to be custom designed.

PFE for Cable Laying Ships

A lesser known, but equally demanding need for PFE is in the cable laying ships. As a cable is placed, it is being tested with a Shipboard PFE system. During the cable laying boom of the 1990's, nearly 100 shipboard PFE systems were put into service. These shipboard PFE systems are functionally very similar to standard land based PFE, only with reduced functionality and requirements, (and a substantially lower price). The shipboard PFE can operate from 220 VAC supplied from ship generators, and generally can use more "Off the Shelf"



Fig. 5



High Voltage power supply units. (No need to carry all those batteries on board and hopefully no seismic events while out at sea). But reliability is still paramount for the shipboard PFE, as a PFE failure out at sea would stop cable deployment until help arrived.

Conclusion

It has been demonstrated with the bringing together of experts in undersea cable powering applications and High Voltage power conversion technology, that highly advanced PFE solutions have been designed and deployed. Future advancements and solutions are in the works, which have the possibility of providing significantly smaller systems with higher voltage capabilities, as well as lowcost, lower-voltage units (e.g. for branching power requirements).

Thanks and acknowledgement to Tyco Telecommunications for their contributions to PFE technology advancement by providing cable powering expertise, and for use of some photos herein.

Functional Role of X-Ray Generators in Industrial Applications

by Boris Sasic, Sam Pindrys and Jim Willsey

ABSTRACT

X-ray generators and tubes work together to provide the performance and reliability demanded in today's industrial X-ray applications. An X-ray generator should offer users the sophistication and flexibility to customize how the generator powers X-ray tubes, provided by all manufacturers, in order to meet the specific requirements of an application.

Since the introduction of the thermionic (hot cathode) X-ray tube in the early 20th Century the same basic design concept is still used in modern X-ray tubes. The primary differentiators are that materials and processes used in the manufacturing of the X-ray tubes have greatly improved performance and reliability has vastly increased since the early days of radiography. To this day, X-ray tubes remain the most critical components of X-ray systems considering their limited life, failure modes and sensitivity to proper application. High voltage power supplies (X-ray generators) designed to drive X-ray tubes need to provide stable and well-controlled electron-acceleration voltage and filament current in order to ensure high quality dose output and maximize tube life. X-ray generators come in two distinct forms: a Monoblock[®], where the X-ray tube is integrated into a single package along with the power conversion hardware and high voltage assembly, or a discrete power supply that powers the X-ray tube via a high voltage interconnecting cable. This paper discusses major failure modes of X-ray tubes: arcing, filament breakdown and focal spot overload and how they influence X-ray generator design. An X-ray generator should absorb high energy developed during arcing events and prevent excessive damage to the X-ray tube; it also needs to ensure maximum tube life by active control of the filament current and adequate cooling of the electronics and X-ray tube, in the case of a Monoblock[®]. The importance of fundamental X-ray generator design techniques to ensure optimal performance and long X-ray tube life in industrial applications should never be underestimated.

Keywords: X-ray generators, X-ray tubes, high voltage, X-ray tube arcing, X-ray tube filament control, Monoblock[®]

INTRODUCTION

An X-ray tube is a vacuum device that converts electrical input power into X-rays. X-ray tubes have evolved from experimental Crookes tubes with which X-rays were first "officially" discovered on November 8, 1895 by the German Physicist, Wilhelm Conrad Röntgen. Although earlier experiments by other scientists may have unknowingly created X-rays, Rontgen is widely recognized as the first to systematically study X-rays as early as 1895. William Coolidge improved upon the Crookes tube in 1913 and by 1920 the Coolidge tube had become the most commonly used hot cathode type X-ray tube.

In the Coolidge tube, electrons are produced by thermionic effect, most commonly, from a tungsten filament heated by an electric current. The filament acts as the cathode of the tube. The high voltage potential is applied between the cathode and anode, the electrons are thus accelerated and then hit the anode.

Although basic operation of the X-Ray tube appears to be very straight forward, choosing the proper X-Ray generator to address an application can make all the difference in achieving optimal performance, reliability and long tube life.

END-OF-LIFE FAILURES OF AN X-RAY TUBE

A well-designed, quality-made and properly applied X-ray tube can have a reliable and trouble-free operating life extending over many thousands of hours. Due to irreversible aging effects, there are two major end-of-life failures: catastrophic arcing and filament burn out.

Arcing

During normal operation, the filament operates at very high temperature (above 1500°C). Over time, a slow process known as Tungsten evaporation metalizes the X-ray tube envelope opposite to the parts at high potential (anode and cathode). The metalized layer increases surface conductivity of the envelope (made out of glass or ceramic) which eventually causes arcing to the wall of the tube. In the case of glass tubes, this arcing can puncture the glass, leading to a permanent failure of the X-ray tube as shown in Figures 1 and 2.

TECHNICAL ARTICLES ABOUT HVPS and HV ELECTRONICS

Power Supply Use and Applications

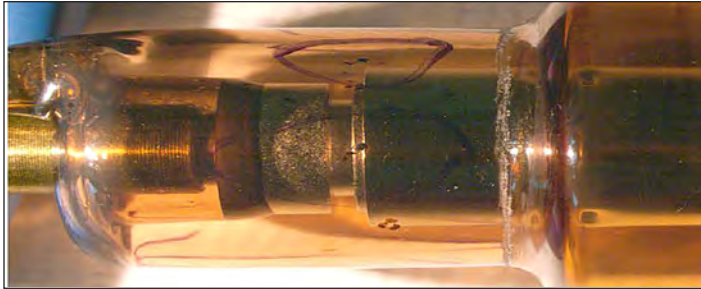

Figure 1: Glass tube with multiple arc marks, some of which punctured the glass envelope.



Figure 2: Magnified arcing area on the glass, showing a damaged tube wall.

This type of failure is predominant in X-ray tubes used close to their maximum voltage ratings. Tungsten evaporation is less of a factor in metal ceramic X-ray tubes since their inherent design minimizes the deposition of Tungsten on the tube wall. However, due to the inevitability of tungsten evaporation in all X-ray tubes, an X-ray generator must manage arcing events through passive and active circuitry to quench and recover from them and prolong the life of the X-ray tube.

Example of Arc Fault Management by the X-ray generator

In many generator designs, Arc management is handled by a DSP (digital signal processor) or microcontroller with the goal of quenching the Arc, most often referred to as “rolling back”. When a discharge occurs it’s important that the generator quickly turn off the high voltage output and re-ramp the HV back to -5% of the arcing event value, providing the tube time to recover and absorb any residual gas molecules. The above steps are all taking place at speeds of <math><1\mu\text{sec}</math>. Modern X-ray generators have fully programmable Arc handling schemes that can be adjusted by the user for various applications and tube requirements.

Arc Detect and Scaling

Arc currents are sensed by a current transformer in the high voltage feedback loop of the X-ray generator as shown in Figure 2a.

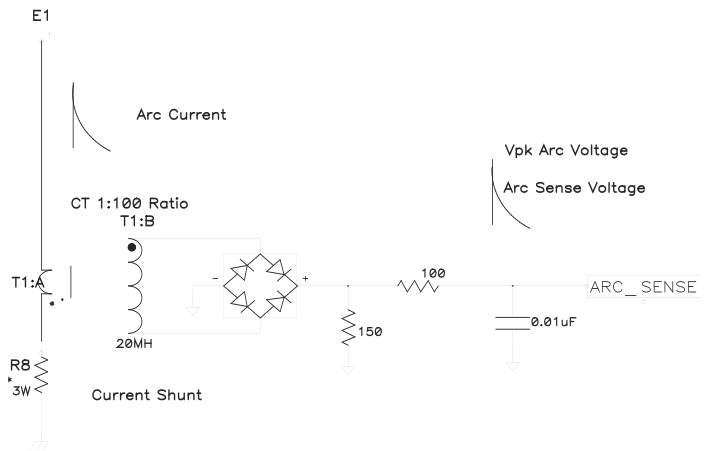

Figure 2a: Example of an Arc Sensing Circuit in an X-Ray Generator

Example of Arc Detect Scaling to kV Program

The scaled arc feedback voltage (ARC SENSE) is fed into a comparator on the system control board which has been scaled to peak arc current limits and the kV program reference level. This scheme helps to avoid false arc detection and micro-arcs are ignored. The ARC signal will be received and latched by the FPGA within hundreds of nanoseconds and disables the kV regulator with the goal of quenching the arc. This quenching is also known as “rolling back”.

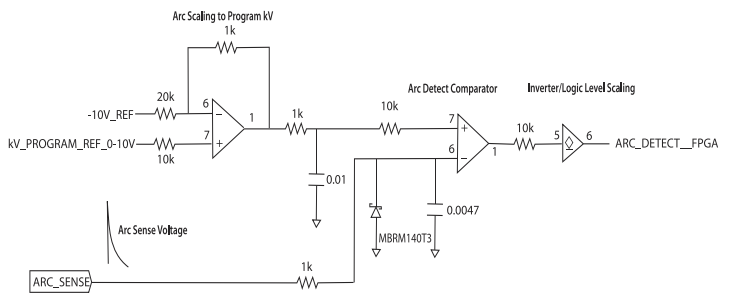

Figure 2b: Example of an Arc Detect to Scaling kV circuit in an X-Ray generator

Example of Ramp Up After Arc Detection

After an arcing event is detected the kV will “roll back” and the DSP has the responsibility of determining if it is appropriate to ramp up the kV or issue a Hard Arc Fault. With each arcing event, the DSP will increment an Arc Counter. If this is the first arc that is detected and the Arc Threshold is >1, the DSP times out an Arc Quench Time interval and re-enables the kV output. This sequence can continue until

TECHNICAL ARTICLES ABOUT HVPS and HV ELECTRONICS

Power Supply Use and Applications

the number of arcs detected exceeds the number of arcs programmed into the arc counter threshold register. The Arc Quench Time and the Arc Counter threshold settings can be set by the user through configurable User Settings.

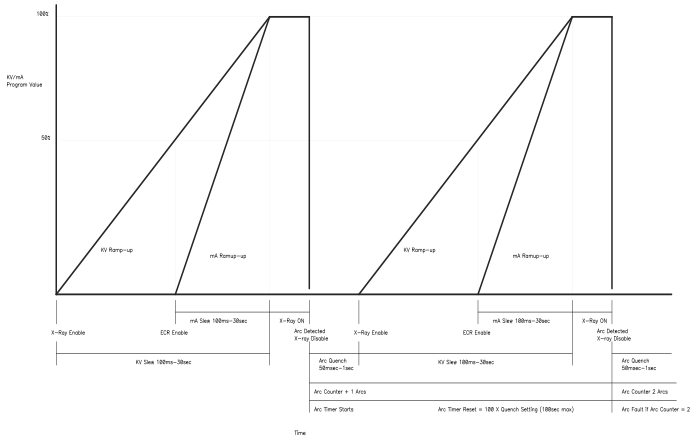

Figure 2c: Example of an Arcing Event with Roll Back, Quench and Ramp Up

Filament burn out

Even in applications where X-ray tubes operate far below their maximum voltage ratings, the envelope metalization still occurs. However, due to the slower rate of metal deposition and higher voltage rating, arcing is not the predominant failure mode. As evidenced by the tube characteristic mA vs Filament current curves shown in Figure 3, when the tube output current is fixed, as the output voltage decreases the filament current increases.

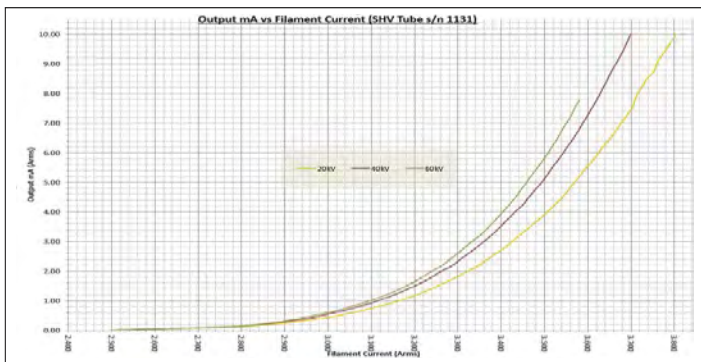

Figure 3: Typical X-ray tube characteristics. When the tube voltage decreases, in order to maintain constant output current, the filament current must increase.

Higher filament current, which reflects the need for higher filament temperature, accelerates filament evaporation proportionally to T⁴ (where T is filament temperature, in Kelvin): even a minor increase in filament temperature, when raised to the power of four, is significantly increasing filament evaporation.

As filament evaporation continues, the filament becomes thinner, eventually leading to the mechanical break of the filament wire. A reduction of about 10% of the filament wire mass is considered to be the practical end of filament life (the filament has reached 98% of its life). This is equivalent to only about 5% reduction of the wire diameter.

Not all X-ray tubes have the same filament characteristics. Different filament characteristics require a different control response to provide stable emission current output. A sophisticated, versatile generator will have an emission control response designed to work with many X-ray tubes. Some X-ray tubes may fall outside of this category and require custom emission loop compensation to insure stable emission output.

ABNORMAL X-RAY TUBE FAILURES

Early failures of X-ray tubes are often the result of inadequate manufacturing processes, materials or misapplication. The former two causes are within the scope of the X-ray tube manufacturer's QA processes, while we are more interested in the proper operation of the X-ray tube from the X-ray generator perspective.

An X-ray generator can help extend tube life by providing stable output voltage with low ripple, low stress start-up conditions and proper HV insulation in an adequate cooling environment, as in the case of an industrial Monoblock®.

Filament ramp-up

One of the most critical items for longevity of industrial X-ray tubes is a low-stress filament turn-on. Filaments need several hundreds of milliseconds to reach operating temperature. If the filament drive ramps-up current through the filament too quickly, there will be a significant mechanical stress on the filament, while the benefits of fast X-ray output ramp up will be minimal. Figure 4 illustrates such a scenario.

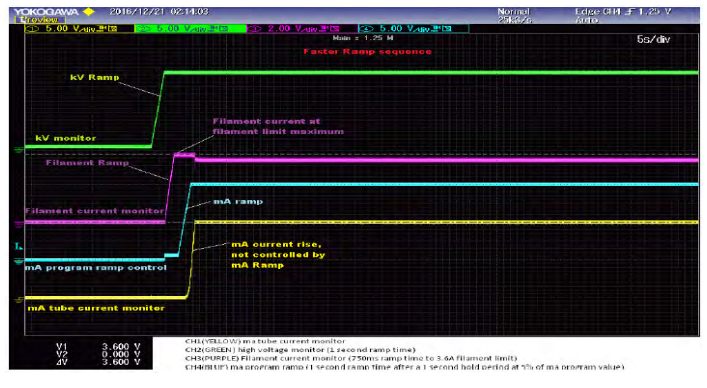

Figure 4: Filament and output currents during fast ramp.

TECHNICAL ARTICLES ABOUT HVPS and HV ELECTRONICS

Power Supply Use and Applications

In this case, the filament current (purple trace) increases quickly, but filament temperature, which is responsible for the output current (yellow trace), cannot reach the operating current set point quickly. As a result, the mA feedback loop will force the filament current to the designed maximum until the filament heats up enough to start emitting X-ray generating electrons. At that point, mA will rise quickly and no longer be controlled as defined by the mA ramp (cyan trace). The filament winding is exposed to a high current for several hundreds of milliseconds and this process is repeated at every turn on of X-rays. The high stress can be a major contributing factor to premature filament failures.

To minimize filament stress, a properly designed X-ray generator will employ programmable filament current ramp and limits which can be customized to manufacturer recommendations for the selected X-ray tube. One such example is shown in Figure 5.

The most critical setting for protecting the filament of an X-ray tube is the Filament Limit. The Filament Limit setting is the maximum current setting specified by the X-ray tube manufacturer to achieve the maximum emission current at the lowest kV. There is no one setting to meet this requirement and it needs to be set up during tube installation. The maximum filament values can be set below the manufacturer's recommended specifications if the required emission current is reached in the application.

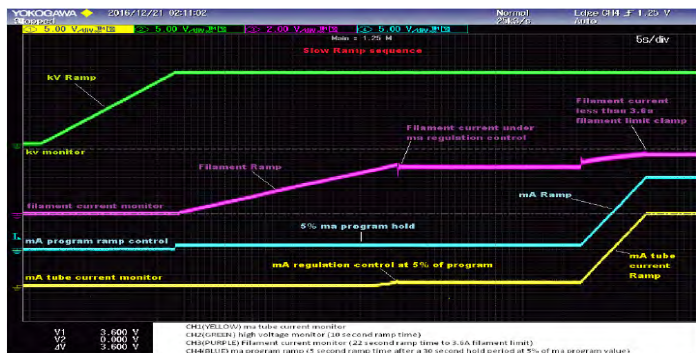

Figure 5: Optimized Filament Current Ramp Up Reduces Stress on the X-ray tube Filament.

When the filament current rise time is controlled in line with the filament's thermal properties, the current limit is never reached and maximum current is the same as the operating current. Moreover, the filament reaches the operating temperature by the time emission current control activates, resulting in a well-defined tube current rise (yellow trace), as dictated by the control circuit (cyan trace).

Effects of HV Cable Length on AC and DC Filaments

As previously discussed, one of the most critical tube settings is the Filament Limit. The Filament Limit set point limits the maximum output current of the filament power supply to protect the filament of the X-ray tube. This should

be set at or below the X-ray tube manufacturer's specification. However, other factors within the imaging chain set up need to be considered.

AC Filament Supply: AC filaments operate at high frequency which introduces potential difficulty to drive power through long HV cables due to impedance. Changing the HV cable length may have an effect on filament calibration so the filament settings should be re-calibrated.

DC Filament Supply: With DC filaments, the copper losses of the HV cable need to be considered due to wire gauge and cable length concerns. Using a DC filament power supply with a current regulation scheme will eliminate the need for any additional adjustments provided the HV cable does not exceed a predetermined maximum length.

X-ray Generator User Configurable Parameters

A versatile X-ray generator will be capable to power a wide variety of X-ray tubes across many applications. Standard ramp ups for kV, mA and filament should be defaulted to slew rates that will meet the application requirements but stay within manufacturer recommended guidelines for safe control of the tube. For tubes that fall outside of those default speeds the X-ray generator should allow for simple setting adjustments.

Some standard X-ray generators take the above to higher levels of configurable and customizable settings. Figure 5a shows a GUI screenshot that provides Users with the ability to tailor the X-ray generator settings specifically to their application and can help optimize performance of the tube/generator combination as well as protect and prolong the life of the X-ray tube. Many of the critical parameters discussed already can be quickly and easily loaded.



Figure 5a – GUI (Graphic User Interface) User Tube Configuration Screenshot

TECHNICAL ARTICLES ABOUT HVPS and HV ELECTRONICS

Power Supply Use and Applications

The below table provides a snapshot into the level of configurability some X-ray generators allow. Every X-ray application has its own differentiating factors and the ability to operate the X-ray tube as required while protecting it has been proven to be a very useful feature.

Parameter/Function	Range	Default	Notes
Large Filament Power Limit XRV160,225 XRV320,450	0-4000W 0-4500W	3000W 4500W	See tube data
Small Filament Power Limit XRV160,225 XRV320,450	0-4000W 0-4500W	3000W 4500W	See tube data
Max kV XRV160 XRV225 XRV320 XRV450	0-160kV 0-225kV 0-320kV 0-450kV	160kV 225kV 320kV 450kV	
Max mA	0-30ma	30ma	
Filament Current Limit Large	0-6A	4A	Cal. Current with actual load
Filament Current Limit Small	0-6 A	4A	Cal. Current with actual load
Filament Preheat Current Large	0-6A	2A	Typical value: Current Limit Large/2
Filament Preheat Current Small	0-6A	2 A	Typical value: Current Limit Small/2
Arc Trip Counter	0-30	1	
Arc Quench Time	10msec-1sec	50 sec	Counter will reset in 100X set value (100sec max.)
kV Slew Time	100 msec-30sec	5 sec	Typical 5 sec
mA Slew Time	100 msec-30sec	5 sec	Typical 5 sec
Pre-warn Time	0-30sec	1 sec	Warning before HV ON (X-Ray ON)

Figure 5b – Example of the Range of Configurable Parameters in the X-ray Generator

As simple as inputting X-ray tube profile values into the generator is, the process can be simplified significantly. If a standard “off the shelf” X-Ray tube is to be used in the application it is easy for the generator manufacturer to input the values into a database so that the User can simply select the proper tube model and load the appropriate settings in automatically. This simplifies the set up process and has the added benefit of eliminating the human error aspect of readying the tube and generator to operate together. Tubes not included in the database can be added and saved to it easily.

In the next section the discussion moves to the generator having the ability to automatically load the X-ray tube settings into the generator by selecting the tube model from a drop down list.

Auto Loading of Tube Parameters with a Drop Down Menu

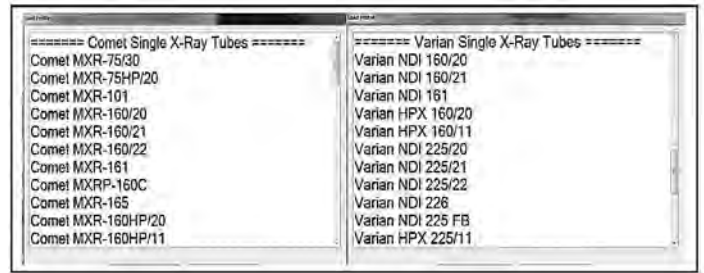

Figure 5c – GUI Drop Down Menu to Auto Load Critical Tube Settings

In a situation where the X-ray tube being used is custom or not included in the drop down menu, the tube profile settings can be manually entered, saved and recalled with ease.

Auto & Custom Tube Seasoning Profiles:

Along with the ability to select the tube model from a drop down menu and load profile information, comes the availability of manufacturer recommended tube seasoning programs as well. Dependent upon the last time the X-ray tube was used or seasoned, the generator can automatically select an appropriate seasoning profile. Daily, weekly and monthly seasoning profiles are available for all tubes in the drop down menu and custom profiles can be created for tubes not included.



Figure 5d – GUI (Graphic User Interface) Seasoning Profile Screenshot

TECHNICAL ARTICLES ABOUT HVPS and HV ELECTRONICS

Power Supply Use and Applications

High Voltage insulation

One of the major challenges in the design of industrial Monoblocks® is providing a low-electrical-stress environment for the X-ray tube operation. Besides proper high voltage insulation, considerations around maximum electric field and field-control techniques are important. The problems caused by inadequate electrical stress controls could result in sudden, fast failures, such as glass punch through, as illustrated in Figure 6.



Figure 6: Tube glass puncture caused by high electrical stress.

In the case of the tube in Figure 6, the glass envelope was punctured by a single arcing event. A typical characteristic for this type of failure is that there are no black marks, more common for end-of-life punctures, where there are multiple arcs causing carbonization before the final breakdown.

Another problem caused by inadequate E-field modelling are the latent failures, where the charged particles start etching the glass, causing increased leakage current and slowly leading to increased arcing events and, finally, to the terminal breakdown. This type of failure is illustrated in Figures 7 and 8.

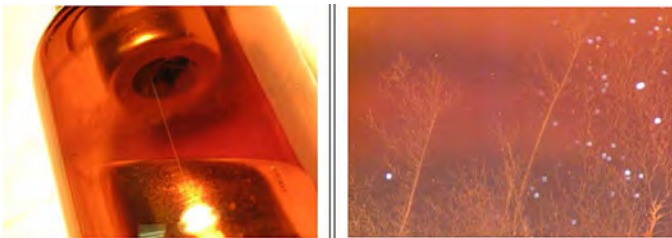

Figures 7, 8: Glass envelope etched in the presence of high E-field.

This type of failure develops over several weeks, or even months. It is especially critical in the early stages as it is difficult to notice: leakage current starts to increase, causing errors in the output current measurement as part of the measured current does not contribute to the x-ray generation. Effectively, the X-ray dose starts decreasing, even though it appears that the tube current is well controlled. Next, an occasional nuisance arc occurs and, as time goes by, the arcing rate increases leading to a permanent failure.

Thermal Management

X-ray tubes are very inefficient devices. Less than 1% of power is emitted in the form of X-rays, while more than 99% is dissipated as heat. In order to ensure longevity of the X-ray tube, this heat needs to be well managed to prevent high temperature rise. Dielectric oil is typically used as a cooling medium with an optimal combination of electrical insulation and thermal properties. These properties make it reasonably easy to circulate the oil through various heat exchangers for cost effective thermal management which can be suited to different applications.

Without proper thermal management, the X-ray tube can be affected in three major ways:

- 1) Increased internal temperatures and rate of evaporation, leading to fatal arcs
- 2) Increased glass temperatures, resulting in burned oil which increases X-ray filtration and reduces the oil's insulation capabilities, which can result in dielectric breakdown in multiple parts of the high voltage assembly. An improperly cooled tube with this type of problem is shown in Figure 9.
- 3) Inadequate heat removal from the anode assembly, resulting in the X-ray tube's target operating above Tungsten's melting point: this results in focal spot melting with three critical side effects:
 - a. Focal spot size increases
 - b. X-rays become harder, due to the additional filtration
 - c. Additional Tungsten evaporation increases metallization process and leads to terminal tube failures



Figure 9: An X-ray tube operated in a hot oil environment with a thin layer of carbonized oil etched onto its surface.



Figures 10, 11: Focal spot damage caused by inadequate anode cooling and thermo-mechanical stress

TECHNICAL ARTICLES ABOUT HVPS and HV ELECTRONICS

Power Supply Use and Applications

Dose Stability

Advances in detector technology are opening doors to new applications and improvements in imaging quality. This, in turn, drives the need for higher quality X-ray sources. One of the critical requirements is X-ray dose stability. X-ray dose stability is greatly dependent upon the operating temperature of an X-ray tube. The tube temperature drift can exceed 10%. This is best illustrated in Figure 12.

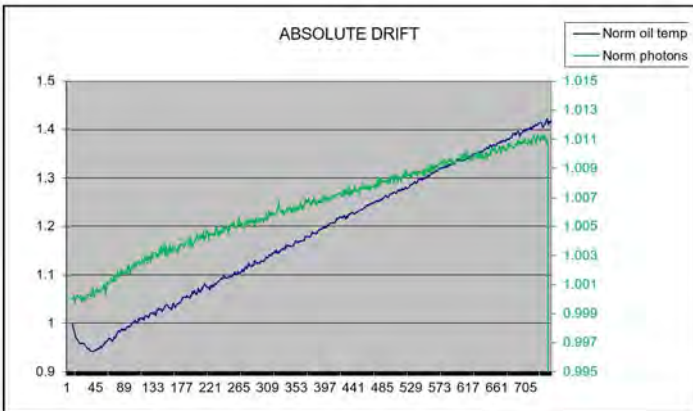

Figure 12: X-ray dose drift as a function of operating temperature. Horizontal axis shows time in seconds.

By employing a combination of analog temperature compensation along with digital characterization and compensation, this significant drift can be minimized to negligible levels. Performance of an optimized x-ray source is shown in Figure 13. It shows maximum drift compensated to the level below 0.4%.

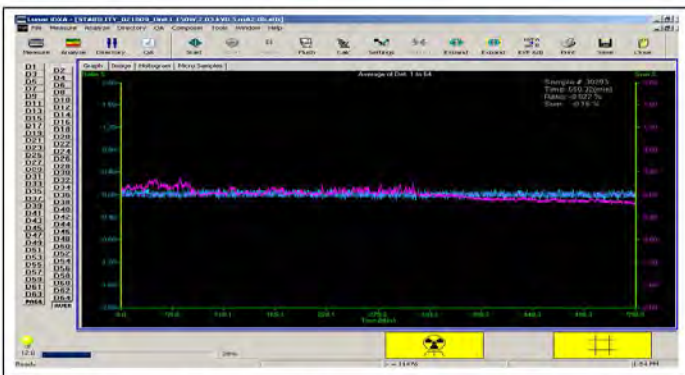

Figure 13: Performance of a compensated X-ray source. The traces show the sum of low and high energy photons (purple trace - proportional to the equivalent mA stability) and ratio of high and low energy photons (blue trace – proportional to the equivalent kV stability).

Dose Loss as a Result of Ramp-Down.

If the tube output power is disabled instantaneously, the anode target will see a steep temperature drop at the surface of the target, resulting in mechanical stress within the target surface layer. This can result in cracks on the target surface, degradation of the focal spot and dose loss. The relative dose loss could be 80% of initial dose after 10000 cycles. Running at power levels 20% below maximum values or implementing power ramp-down into the generator on/off switching will significantly reduce stress on the target.

CONCLUSION

As industrial imaging technologies evolve and X-ray source requirements become more demanding, it is becoming exceedingly important that tubes and generators work together to provide optimal performance, reliability and value. Even the best X-ray tube requires an exceptional generator to perform at its peak and protect it from common failure modes. It's a mistake to underestimate the importance of using a generator that has been designed with the needs of the X-ray tube in mind. As discussed in this paper, an X-ray tube has a useful life cycle based on well known, inevitable failure modes. A generator, designed to enhance the life and performance of an X-ray tube, that is reliable, serviceable, flexible, simple to integrate and has a low cost of ownership should always be a top consideration in the selection of imaging chain components.

References

- A. Wilson: "Tungsten Filament Life Under Constant-Current Heating", Journal of Applied Physics, vol. 40 No. 4 Pg. 1956, 15 March 1969
- Jones, Mackay: "The Rates of Evaporation and the Vapor Pressure of Tungsten", Physical Review, Vol. XX No. 2, August 1927
- T. Newton, D. G. Potts: "Radiology of the Skull and Brain - Technical Aspects of Computed Tomography", The C. V. Mosby Company, 1981
- W. H. Kohl: "Materials Technology for Electron Tubes", Reinhold Publishing Corporation, 1951
- Application Manual, Stupakoff Ceramic and Manufacturing Co.
- X-Ray Tube, (n.d.) In Wikipedia, Retrieved July 6, 2018, From, https://en.wikipedia.org/wiki/X-ray_tube

Design and Testing of a High-Power Pulsed load

Alex Pokryvailo, Arkady Kogan and Cliff Scapellati
Spellman High Voltage Electronics Corporation

Presented at 28th Int. Power Modulators Symp., Las Vegas,
27-31 May, 2008, pp. 181-184.

ABSTRACT

This paper describes the design and testing of a two-channel 52-kW pulsed load. Its main feature is exceptionally low parasitic inductance, on the order of 200nH. Such low inductance was needed in view of microsecond high-current pulses; it was realized by a compact design and careful layout. Small size is a prerequisite for minimizing the inductance; it was achieved by forced liquid cooling. Non-inductive bulk resistors were used at a power rating far exceeding their specifications detailed for operation in air and were found adequate for their mission. They were housed in standard stainless steel drums. The cooling liquid (water-propylene-glycol mixture) was circulated through a heat exchanger.

Multiple aspects of the design are described, including resistor choice, calculating the load inductance, choice of busbars, details of kinematic scheme, heat transfer, HV, safety and other considerations for cooling agents, etc. Special attention was paid to avoiding turbulent flow that could result in the resistor cracking. Inductance measurements showed close correspondence with the calculations. High-power testing showed reliable operation with overheat about 40 K above ambient.

INTRODUCTION

Pulsed resistive dummy loads are widely used in various HV applications, e.g., testing capacitor charger systems, nanosecond and picosecond pulsers, etc. Such loads are characterized by several distinct requirements placing them apart from more conventional DC or AC loads. One of the most difficult requirements is providing low parasitic inductance. It must be of the order of several hundreds of nH, and tens of nH for microsecond and nanosecond applications, respectively. A natural way of minimizing the stray inductance is using low-inductive layouts, preferably, coaxial ones, and minimizing the overall load size. At high average power and high voltage, the latter is difficult to satisfy without effective cooling and keeping proper insulation distances. An additional typical requirement is good long-term resistance stability; this effectively excludes various aqueous solutions, such as copper sulfate aqueous solutions.

This paper describes the design and testing of a two-channel 52-kW load used in the development of a high repetition rate capacitor charger.

DESIGN

Specifications

The load was designed to the following specifications.

- 1.) Storage capacitance: $C=5.3\mu\text{F}$ (per channel)
- 2.) Max charge voltage: $V_{ch}=1200\text{V}$
- 3.) Max Average power: $P_{av}=52\text{kW}$ (26kW per channel)
- 4.) Pulse width: $t_{pulse}\approx 5\mu\text{s}$
- 5.) Max pulse repetition frequency (PRF): 6kHz
- 6.) Load inductance:
(per channel, excluding leads) $L_{load}\approx 0.2\mu\text{H}$
- 7.) Voltage reversal (at maximum charge voltage):

- in normal operation	200V
- in abnormal operation	600V
- 8.) Possibility of reconfiguration to accept pulsed voltage of several tens of kV.

Circuit Considerations—Choice of Resistance

The test circuit can be represented by a capacitor discharge onto r, L circuit, r, L being the load resistance and inductance, respectively (Fig. 1), the latter including the leads' inductance.

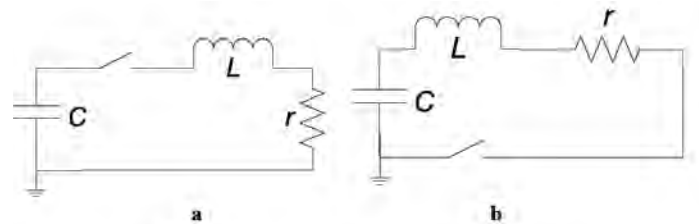

Fig. 1. Equivalent circuit for determining load resistance and inductance.

TECHNICAL ARTICLES ABOUT HVPS and HV ELECTRONICS

Research Papers

With zero initial conditions, in Mathcad notation, the load current, *i*, and the capacitor voltage, *v*, are given by the formulae

$$i(t, L, r) := \frac{V_0}{L(\alpha_1(L, r) - \alpha_2(L, r))} \cdot (\exp(\alpha_1(L, r) \cdot t) - \exp(\alpha_2(L, r) \cdot t))$$

$$v(t, L, r) := -\frac{V_0}{(\alpha_1(L, r) - \alpha_2(L, r))}$$

$$\cdot (\alpha_2(L, r) \cdot \exp(\alpha_1(L, r) \cdot t) - \alpha_1(L, r) \cdot \exp(\alpha_2(L, r) \cdot t))$$

where

$$\alpha_1(L, r) := \frac{-r}{2L} + \sqrt{\frac{r^2}{4L^2} - \frac{1}{L \cdot C}} \quad \alpha_2(L, r) := \frac{-r}{2L} - \sqrt{\frac{r^2}{4L^2} - \frac{1}{L \cdot C}}$$

With the target loop inductance *L*=1.5μH, the voltage reversal of approximately 200 V and *t*_{pulse}≈5μs are realized with the load resistance *r*=0.6Ω (Fig. 2). A reversal of ≈600V can be provided by increasing the leads' inductance to 10μH, or decreasing *r* to 0.25Ω. Fig. 3 illustrates the capacitor voltage waveforms for non-inductive discharge (*L*=0.2μH) and artificially increased *L*=10μH.

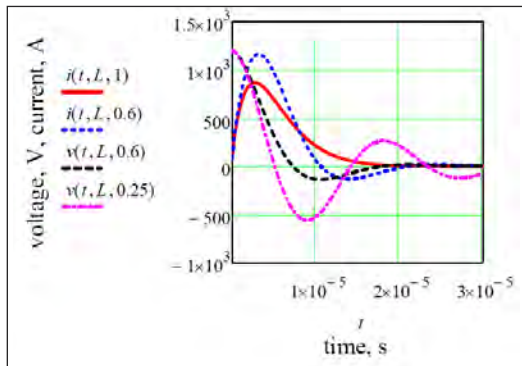

Fig. 2. Current and voltage waveforms for *L*=1.5μH; *r* values (in S) as indicated in variables' legends. *r*=1Ω corresponds to critically damped discharge.

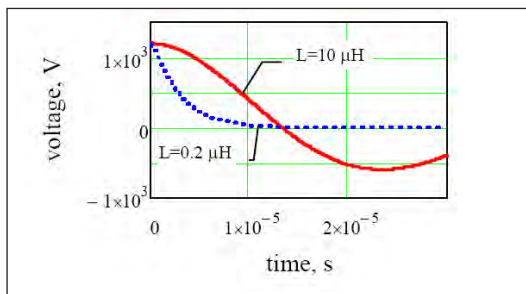

Fig. 3. Current and voltage waveforms for *r*=0.6Ω.

Realizing the desired resistance and reconfiguring the load is convenient with relatively large number of fixed resistors. Their choice is of prime importance influencing the overall size, cost and reliability. In view of low inductive design, bulk ceramic resistors were chosen. They performed well in nanosecond applications with forced oil cooling [1], which was instrumental in obtaining small size, hence low inductance. Kanthal Global series 510SP slab resistors are relatively inexpensive, compact and easy to mount. The largest parts are specified for the maximum power dissipation of 150W in air; with oil cooling, based on previous experience, we anticipated good safety margin at a 500-W load. A brief testing of 887SP resistors in static transformer oil showed that it was capable of bearing the load of 500-1000W without excessive stress. The main danger, as indicated by the manufacturer, is bringing the cooling agent to the boiling point, which would result in the ceramics cracking. Thus, it is important to avoid turbulent flow in order to decrease the temperature gradients at the boundary.

Finally, 6.3Ω ±20% resistors were chosen. With 48 resistors per channel (~500W per resistor), the connections are as shown in Fig. 4. The nominal resistance is 0.525Ω, and the measured value is close to 0.6Ω. The load can be re-configured to 2.4Ω, 1.2Ω or 0.3Ω without major changes.

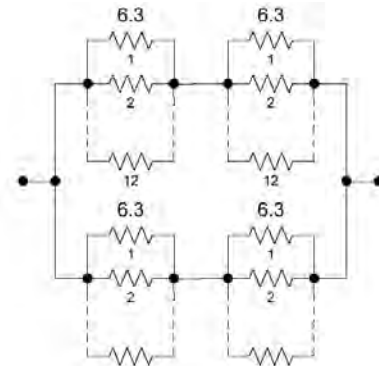

Fig. 4. Electrical connections (one channel).

Mechanical Layout

The load inductance *L*_{load} is a sum of the resistor assembly inductance and the auxiliary and main busbars' inductances. An equivalent circuit (illustrating also the geometrical arrangement and parasitic resistances) is shown in Fig. 5. According to it, *L*_{load} can be calculated as

$$L_{load} = \frac{(L_R + L_{aub})}{2} + L_{mb}$$

where *L*_R is the inductance of the resistor pack of 12, and *L*_{aub}, *L*_{mb} are the auxiliary and main busbars inductances, respectively.

TECHNICAL ARTICLES ABOUT HVPS and HV ELECTRONICS

Research Papers

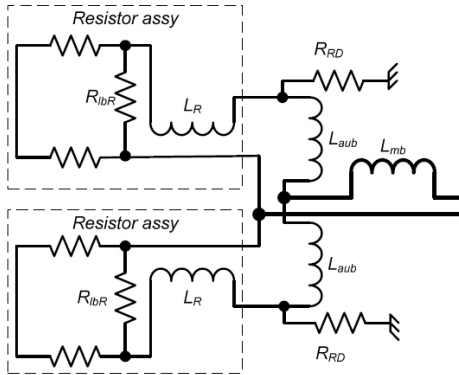

Fig. 5. Equivalent circuit of resistive load accounting for parasitic inductances and coolant conductance.

Minimizing the volume occupied by the magnetic field is key to achieving low inductance. With this in mind the resistors were grouped twelve in parallel in one plane, the return path being provided by another group of twelve (see photo Fig. 6a). The inductance calculation for such an arrangement may be performed for a flat busbar approximation using the following formula [2]:

$$L_{\text{wv}} := \frac{\mu_0}{\pi} \cdot \left(\ln\left(\frac{d}{b+c}\right) + \frac{3}{2} + f \right)$$

where μ_0 is the permittivity of free space, d is mean distance between the bars, b , c are the bar thickness and width, respectively, f , ϵ are tabulated values. For the resistor assembly, $d=0.06$ m, $b=0.02$ m, $c=0.3$ m, $f=0.8$, $\epsilon=0.002$, which yields $L=2.5 \times 10^{-7}$ H/m, or $LR=7.5 \times 10^{-8}$ H for the resistor pack having a length of ~ 0.3 m. This calculation was also verified by finite element analysis. Since there are two packs connected in parallel, their inductance is halved (see equivalent circuit Fig. 5). The auxiliary and main busbars inductances L_{aub} , L_{mb} add ~ 100 nH, so the overall load inductance was expected not to exceed 200-300nH. Actual measurement provided a value of $L=200$ nH (Quadtech 1920 LCR meter, measurement taken at 10kHz).

The resistor assembly fits into a standard 20-gal stainless steel drum (Fig. 6b) and is suspended by the main busses on a Lexan lid that serves also as a bushing.

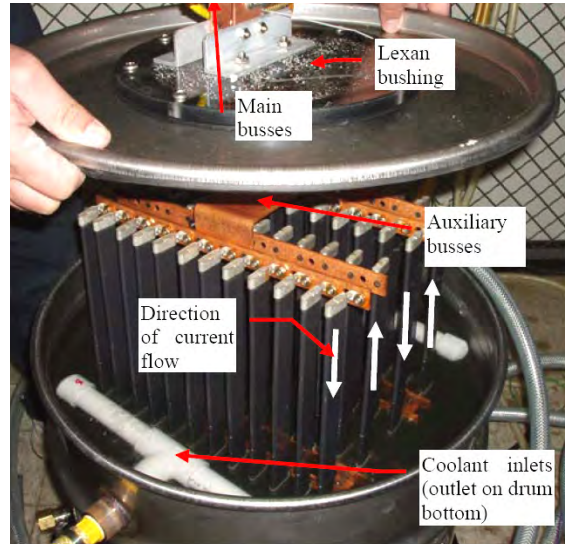

Fig. 6. Resistive load being immersed into coolant (one channel). Load is fully isolated from drum.

Kinematic Diagram

The system works on a closed cycle. The cooling agent is circulated through the two vessels with loads by means of a pump and gives heat away in a heatsink provided by a fan (Fig. 7). The flow is monitored by flowmeters, and the flow rate can be roughly regulated by valves installed on the drums. The hosing system is symmetrical with regard to the loads; no other special means for balancing the load was designed. Overheat condition that may occur following the pump failure, clots, etc., is prevented by interlocking provided by thermostats monitoring the drum temperatures.

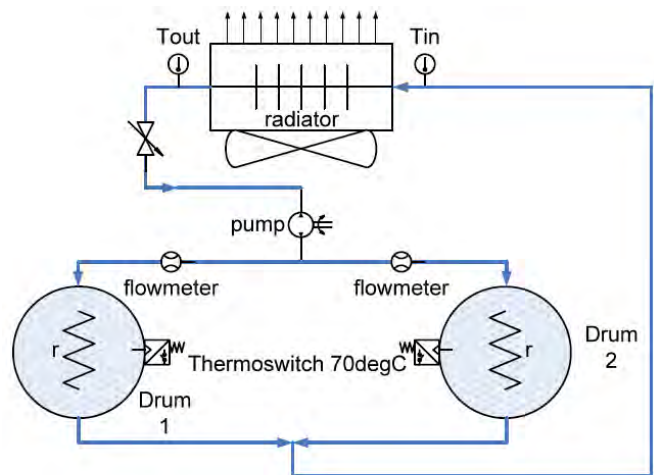

Fig. 7. Kinematic diagram of cooling system.

TECHNICAL ARTICLES ABOUT HVPS and HV ELECTRONICS

Research Papers

Cooling Agents

Insulating liquids, such as transformer or silicone oil have good dielectric properties and satisfactory cooling capability, and thus would be an ideal choice. The required flow rate can be calculated using the formula,

$$m = \frac{P}{c_p \Delta T},$$

where P is the dissipated power, $P=52\text{kW}=177,000$ BTU/hr, c_p is specific heat capacity, or just specific heat, at constant pressure, and ΔT is the target temperature difference. Assuming $\Delta T=50^\circ\text{C}$ between the drum and the outlet of the heat exchanger, we calculate the mass flow rate Q_m per channel for oil with $c_p=2\text{kJ/kgK}$ $Q_m \approx 0.5\text{kg/s}$, or the volumetric flow rate $Q_v \approx 30\text{l/min}$ (≈ 8 gal/min). Such flow rate can be easily provided by conventional pumps. However, the problem in using oil is poor safety related to flammability and risk of spillage. Therefore, notwithstanding concerns about dielectric strength and corrosion, we considered Ethylene Glycol (EG), Propylene Glycol (PG) and their water mixtures used widely as antifreezes. Deionized water was discarded in view of expected corrosion and loss of dielectric properties over prolonged service.

EG and its water mixtures have been used in pulsed power (see, e.g., [3], [4]), mainly owing to large permittivity (≈ 40 for EG). For withstanding long pulses (several microseconds and longer) water should be clean, and the solution chilled.

Literary data on resistivity of EG and PG, and especially their solutions, are difficult to find. The only authoritative reference to this property was found in [5]. Some additional information is contained in [6]. According to [5], EG resistivity is $\rho \approx 104\Omega \cdot \text{m}$ at 20°C . A short test was done in-house to estimate this parameter. Two flat electrodes with the area of 7cm^2 , distanced by 0.5 mm, were immersed into liquid. A Prestone EG-based coolant (presumably, 97% EG) had $\rho \approx 140\Omega \cdot \text{m}$ at room temperature at a DC voltage of 10V . Deionized water had $\rho \approx 0.7 \times 104\Omega \cdot \text{m}$ at 200V , so it was assumed that the mixture would have resistivity not less than that of EG. Curiously, the measured values can be considered favorable in the light of experimental data [7], where the maximum of the dielectric strength for electrolytes, in quasi-uniform fields under the application of long “oblique” pulses, was found at $\rho \approx 2 \div 3.5 \times 102\Omega \cdot \text{m}$.

Obviously, the surrounding liquid acts as a shunt for the load resistors. For the described geometry, the coolant shunt resistance (see Fig. 5) may be estimated at 10Ω at

room temperature, considerably larger than the resistor assembly. The temperature rise may decrease this value greatly, by an order of magnitude for $20 \div 30\text{K}$, as inferred from [3], [4].

Analyzing possible load connections Fig. 1, we note that option b, when the load is tied to ground is preferable in that the voltage is applied to the coolant only during the capacitor discharge, and thus the coolant is stressed during several μs only. The parasitic current then flows between the resistor assemblies (resistances R_{lB}) and between the resistors and the drum (resistances R_{RD})—see Fig. 5. In option a, the voltage across the coolant resides all the time during the charge, when the current flows through R_{RD} , and until the capacitor has been discharged.

We note that in the present implementation our primary concern resides with the resistance stability, and not with dielectric strength: the insulation distances are several centimeters and are ample enough to hold, probably, hundreds of kV at microsecond durations. We do not have substantive information on the dielectric properties of water-glycol mixtures at much longer pulses; however, some useful estimations can be made to this end. The power dissipation in the liquid is,

$$P = \frac{V_{ch}^2}{R_{liq}},$$

or 1 MW at $V_{ch}=1200\text{V}$ and $R_{liq}=1.44\Omega$ (see Test Results, following). If applied continuously, such power would bring the mixture to boiling, which can be considered as coinciding with breakdown at long pulses. Thus, the time to breakdown can be estimated as

$$\tau_{brd} = \frac{c_p m \Delta T}{P}$$

assuming adiabatic heating and constant R_{liq} . For the liquid mass $m=70\text{kg}$, $\Delta T=50$ K, $c_p=3.56$ kJ/kg \times K we calculate $\tau_{brd} \approx 12\text{s}$. Such a situation, although hypothetical in view of the necessity to invest hugely excessive power to sustain the storage capacitor charged, cautions against connection Fig. 1a.

EG is highly toxic, so eventually a Prestone PG diluted by deionized water in a proportion of 50%-50% was chosen as a coolant. PG specific heat of 2.51 kJ/kg \times K is close to that of EG (2.41 kJ/kg \times K) [8], and in 50%-50% water mixture $c_p=3.56$ kJ/kg \times K, about 85% of specific heat of water. Thus, the flow rate can be considerably lower than that for oil circulation.

TECHNICAL ARTICLES ABOUT HVPS and HV ELECTRONICS

Research Papers

Prolonged runs at full power of 52kW showed that the drums' temperature (measured in the midsection using thermocouples) was 60°C÷70°C (depending on ambient temperature and the position of the heat exchanger) at a flow rate of 20l/min. The ambient temperature in the test compartment was maintained by a chiller at 23°C, although the temperature around the drums was considerably higher. No sign of resistors degradation except steel tabs rusting was noted; the coolant, however, became opaque and slimy, and the busbars were also coated with slime. The coolant resistance as measured at high current of up to 3A using a DC power supply varied from 9Ω at 11°C (fresh mixture, kept in the drum for about a month) to 2.8Ω at 18°C (aged mixture), to 1.2Ω at 54°C (aged mixture). This corresponds to the observed increase of the discharge current by ~10% at hot conditions (67°C) compared to cold operation (23°C—see Fig. 8).

Electro-corrosion that is disregarded in short-pulsed systems is an important issue for investigation for this application. Measurement is based on the

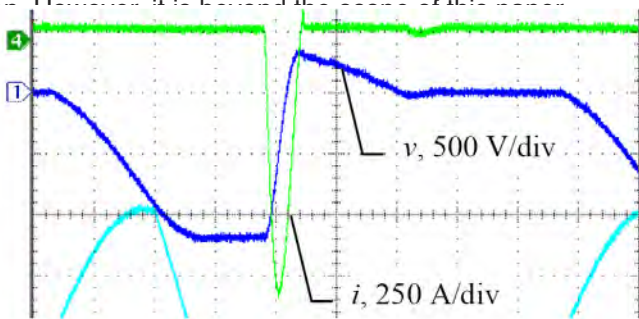

The authors thank Mr. C. Carp, Mr. R. MacArthur, Mr. J. LaMountaine and Mr. D. Ryan, all of Spellman High Voltage, for valuable help in design and conduction of the experiments.

- 1.) A. Pokryvailo, M. Wolf, Y. Yankelevich, S. Wald et al., "High-Power Pulsed Corona for Treatment of Pollutants in Heterogeneous Media", IEEE Transactions on Plasma Science, Vol. 34, No. 5, October 2006, pp. 1731-1743.
- 2.) P. L. Kalantarov and L. A. Zeitlin, Inductance Calculation, 3rd Ed., Leningrad, EnergoAtomIzdat, 1986 (in Russian). D.B. Fenneman and R.J. Gripshover, "High Power Dielectric Properties of Water Mixtures", Proc. 2nd Pulsed Power Conf., 1983, pp. 302-307.
- 3.) M. Zahn, Y. Ohki, D. B. Fenneman, R. J. Gripshover, and V. H. Gehman, "Dielectric Properties of Water and Water/Ethylene Glycol Mixtures for Use in Pulsed Power System Design", Proc. IEEE, vol. 74, No. 9, Sept. 1986, pp. 1182-1221.
- 4.) Encyclopedia of Chemistry, vol. 5, p. 984. Ed. N. Zefirov, Bolshaya Rossijskaya Enziklopedia, Moscow, 1998 (in Russian).
- 5.) J. Liu, X. Cheng, J. Pu, J. Zhang, "Experimental Study of the Electrical Characteristics of Ethylene Glycol/Water Mixtures in the Microsecond Regime", IEEE Electrical Insulation Mag., Nov/Dec 2007—Vol. 23, No. 6, pp. 20-25.
- 6.) Impulse Breakdown of Liquids, Ed. V. Y. Ushakov, Springer, 2007, p. 283-284.
- 7.) CRC Handbook of Physics and Chemistry, 82nd Ed., Ed. D. R. Lide, CRC Press, 2002.

Accurate Measurement of On-State Losses of Power Semi-Conductors

Alex Pokryvailo and Costel Carp
Spellman High Voltage Electronics Corporation

Presented at 28th Int. Power Modulators Symp., Las Vegas, 27-31 May, 2008, pp. 374-377.

ABSTRACT

For safe design, the junction temperature should be kept within the specified range. Three methods are used most often for determining the power losses:

1. Calorimetric method;
2. Using calibrated heatsinks;
3. Electrical measurements of the device voltage and current, and finding the losses by integrating these variables.

The paper concentrates on the third method with the emphasis given to the accurate measurement of the on-state voltage. The techniques of using non-linear dividers with deep voltage clamping are discussed. Novel circuits allowing faithful measurements of the on-state voltage along with good timing resolution of the switching transitions are proposed. Results of circuit simulations are borne out by extensive testing. Examples of measurement of the on-state voltage of large IGBT modules and free wheeling diodes (FWD) are presented. The obtained results are applicable for characterizing various power switches, e.g., gas discharge devices.

INTRODUCTION

For safe design of switch-mode power conversion systems, the junction temperature, T_j , of power semiconductors should be kept within the specified range. A practical method of calculating this parameter is using the following formulae:

$$T_j = T_c + \Delta T_j, \quad \Delta T_j = QR_{th(j-c)},$$

where T_c is the case temperature, T_j is the junction temperature rise over the device case, Q is the component power loss, and $R_{th(j-c)}$ is the thermal resistance, junction to case, specified by the manufacturer. All the indicated temperatures can be readily measured; determining the power losses, involves more effort.

Three methods are commonly used:

4. Calorimetric method (see, e.g., [1]);
5. Using calibrated heatsinks;
6. Electrical measurements of the device voltage v and current i , and then finding losses E by integrating:

$$E = \int_0^T v i dt,$$

where T is the period. The power loss is found as $P = E/T$, where $f=1/T$.

The first method provides accurate and most reliable results, but is difficult to implement, especially in air-cooled setups. The second method is simpler but inconvenient for the breadboard setups with ever-changing cooling schemes. We will discuss in more depth the third method as most flexible and understandable for electrical engineers.

Eq. (1) works out well only if the current and voltage measurement are correct. In view of a very large dynamic range of the voltages in the on- and off states, it is difficult to devise a one-stop setup, although there are recommendations how to circumvent this problem [2]. One needs high-quality probes and a good scope; this alone does not guarantee faithful measurements. Ensuring safety is realized with differential probes, at a price of compromising the measurement accuracy in view of their limited bandwidth and capacitive effects.

In determining the switching losses, good time resolution is of prime importance, whereas the dynamic range is less important. For hard switching topologies, these losses may be estimated using the datasheets. In soft switching circuits, the conduction losses dominate, and switching losses may be often neglected. Here the accurate measurement of the on-state voltage comes to the front plan. The following discussion concentrates on this problem.

Basic technique of narrowing the dynamic range is voltage clamping using non-linear dividers (see, e.g., [3]). Fig. 1 shows two examples of such dividers. Implementation a uses N low-voltage diodes connected in series, so when the applied voltage drops below NV_{df} , where V_{df} is the diode forward conduction threshold, there is no current flowing through R_1 , and the voltage at the scope input equals HV_m . Circuit b functions similarly.

TECHNICAL ARTICLES ABOUT HVPS and HV ELECTRONICS

Research Papers

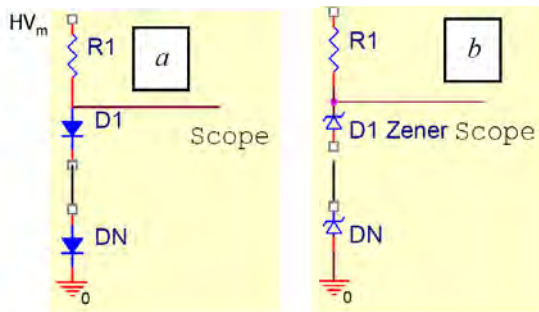

Fig. 1. Schematics of basic nonlinear voltage dividers.

Experimental techniques and measurement means are described further in the body of the text.

SHORTCOMINGS AND LIMITATIONS OF BASIC CIRCUITS

Circuits Fig. 1 depict idealized, and if realized, the ideal devices for measurement of low voltages in high dynamic range. In reality, there are several factors that limit the applicability of these schemes as given in Fig. 1. We skip here obvious component ratings constraints.

One limitation is the inertia introduced by the time constant of the measuring circuit, where $C_p = C_{pr} + C_{pd}$ is the capacitance of the scope input (including the probe), C_{pr} , in parallel with the dynamic capacitance of the diodes/Zener diodes, C_{pd} . Passive voltage probes have typical capacitance of 10pF, so with $R1 = 10k\Omega$, the time constant of the circuit a may be $\sim 10^{-7}$ s, i.e., quite small if the diodes' capacitance can be neglected. However, the diodes remain forward-biased for some time after the voltage HV_m drops below the threshold value, since there is no reverse voltage applied to them. This time may be about $1\mu s$ for diodes specified for $trr = 75ns$ recovery, such as BYM26E, as show experiments and PSpice simulations. It takes the diodes $\sim 0.5\mu s$ to come to a non-conducting state, because the reverse current is very small and unable to evacuate the stored charge fast.

Using signal diodes with trr of the order of a few nanoseconds resolves the stored charge problem as show simulations with 1N4500 diodes having $trr = 6$ ns. However, these and similar diodes (in experiments, we used MMBD914, $trr = 4ns$) have significant forward current of tens of μA at tenths of a volt, which translates to a voltage drop across R1 of the order of 1V. Thus, large number of diodes should be connected in series to reduce this effect, with some uncertainty remaining.

The capacitance of Zener diodes, on the opposite of the diodes use, must be accounted for, and in this case, the

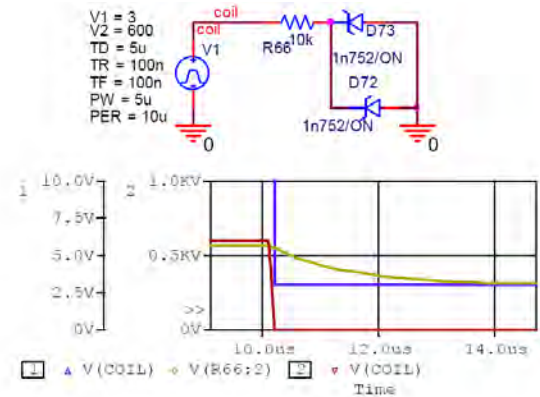

Fig. 2. PSpice simulation of circuit Fig. 1b with Zener diodes. Net aliases in this and following figures show connectivity (e.g., source V1 is connected to point "coil" of circuit Fig. 2).

time constant is on the order of a microsecond. This is larger than typical switching times and commensurable with the pulswidth at high conversion frequency. Fig. 2, Fig. 3 illustrate this statement. The experiments were conducted with a half-bridge quasi-resonant inverter. A Rogowski coil CWT15 [4] was used for monitoring the components current. Since it is an essentially AC probe, the current traces are usually biased. In Fig. 3, the bias in the emitter current, I_e , was removed numerically.

IMPROVED PRACTICAL CIRCUITS

The detrimental action of the Zener capacitance can be rectified using a fast diode connected in series as shown in Fig. 4 that simulates the actual circuit (except the Zener diodes were 1N751A, and the diode was MMBD914). Simulations Fig. 4 correspond to the measurements of Fig. 5. It is seen that the on-state transition is faster and less noisy compared to Fig. 3. This is important for the loss calculation using (2). We note that a circuit similar to that of Fig. 4 is described in [3], but the actual waveforms exhibit slow $\sim 2\mu s$ transitions, which might be related to the use of an unsuitable diode.

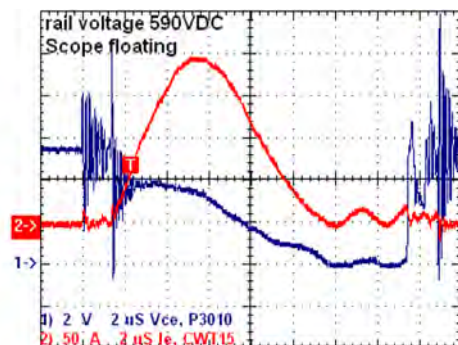

Fig. 3. Measurement of collector-emitter voltage V_{ce} of CM300DC-24NFM Powerex IGBT using circuit Fig. 2. TDS 3024B scope is floating. In this and further plots, waveform notes carry scale information and types of probes used.

TECHNICAL ARTICLES ABOUT
HVPS and HV ELECTRONICS
Research Papers

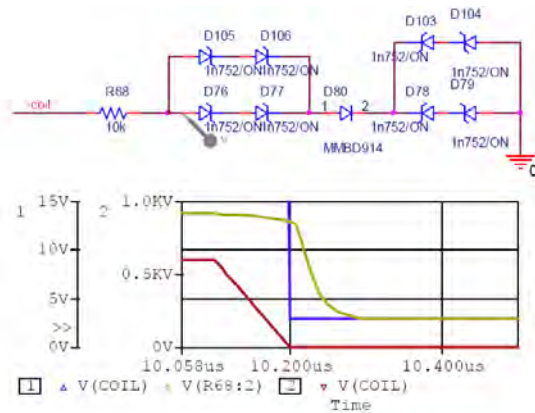

Fig. 4. Blocking Zener diode capacitance using a fast diode. Circuit excited by source V1 Fig. 2.

Although measurements Fig. 5 can be believed to be true in the sense that the voltage between the measurement points was recorded faithfully, the actual Vce voltage is different from it owing to the IGBT internal inductance LIGBT. The inductive voltage drop can be deducted from the measured voltage; a corrected waveform calculated for LIGBT=20nH is shown in Fig. 6.

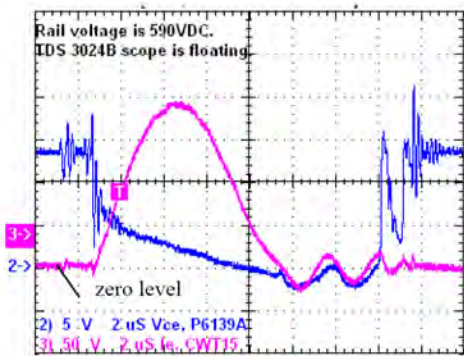

Fig. 5. Measurement of saturation voltage Vsat (collector-emitter voltage Vce.) of CM300DC-24NFM using circuit Fig. 4. Scope is floating.

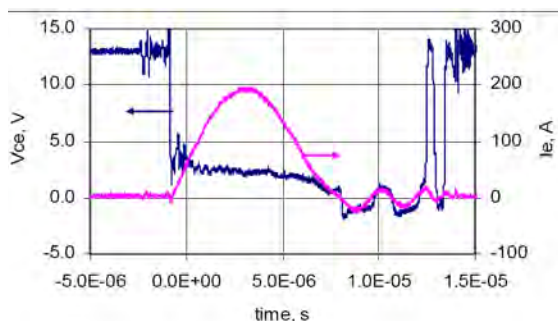

Fig. 6. Vce adjusted for inductive voltage drop (numerical filtering has been applied). It corresponds to CM300DC-24NFM datasheet.

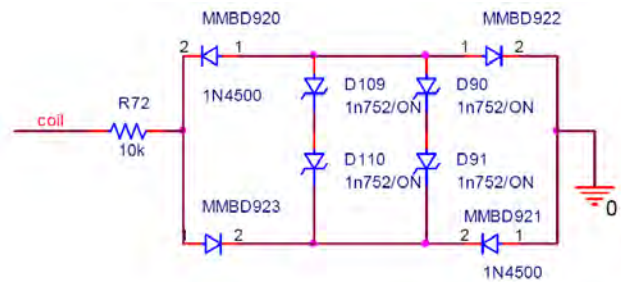

Fig. 7. Bridge formed by fast diodes around a Zener diode works equally well for measurement of positive and negative low voltages in wide dynamic range. Circuit excited by source V1 Fig. 2.

Fig. 8 shows the trace of an IXYS DSEI 2x61 FWD current (one module contains two diodes connected in parallel) together with the voltage trace taken with the divider Fig. 4 (fast diode removed) with the scope floating. The voltage trace has almost a sine wave form with a slow falltime, which is a measurement error caused by the inherent defect of this circuit (Zener diode capacitance).

Using a divider Fig. 7 provides a different picture and is believed to improve the measurement considerably as seen in Fig. 9 that shows also an adjusted waveform and loss curves. Again, the actual forward drop is lower by the inductive component.

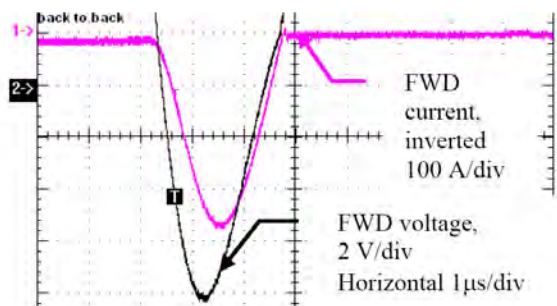

Fig. 8. Trace 2 - Forward drop of FWD IXYS DSEI 2x 61 (negative part). Clamped positive voltage (diode non-conducting) is off-scale. Zener diode capacitance (divider Fig. 4) affects the voltage fall time.

TECHNICAL ARTICLES ABOUT HVPS and HV ELECTRONICS

Research Papers

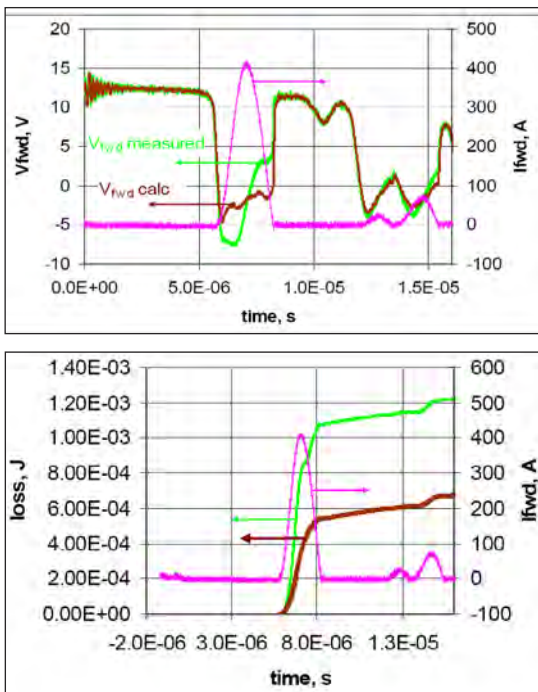

Fig. 9. FWD IXYS DSEI 2x61 losses. Plot a – green trace is measured signal; brown trace is V_{fwid} adjusted for inductive drop LdI_{fwd}/dt (diode assembly inductance assessed at 5nH). Green and brown curves plot b match their counterparts in plot a. Divider Fig. 7, Floating scope.

They are less “trustworthy” in our opinion than their floating counterparts Fig. 5, Fig. 9 (see also the superposition of the differential and floating measurements Fig. 12), which can be explained by the probe limited bandwidth (25MHz for P5200 compared to 500MHz for P6139A), leads’ capacitance to ground in addition to a 7pF capacitance of each input (estimated 30pF total), and by the large voltage swings ($\sim 360V$ at a rail voltage of 600V) of the inputs relative to ground. Therefore, battery-fed scopes, such as Tektronix TPS series are preferential for this task. Even better, universal, and less expensive solution is using regular scopes fed from an uninterruptible power supply disconnected from mains. Usual safety precautions should be taken in floating measurements.

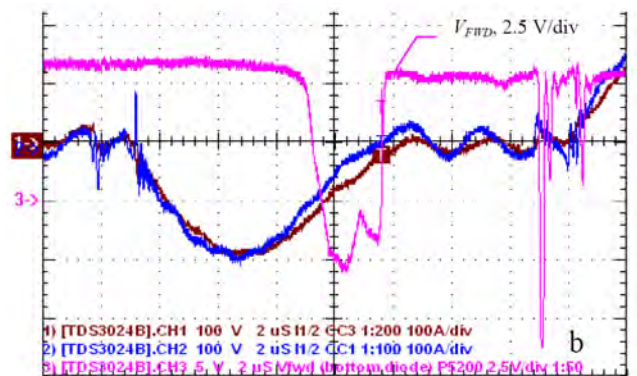
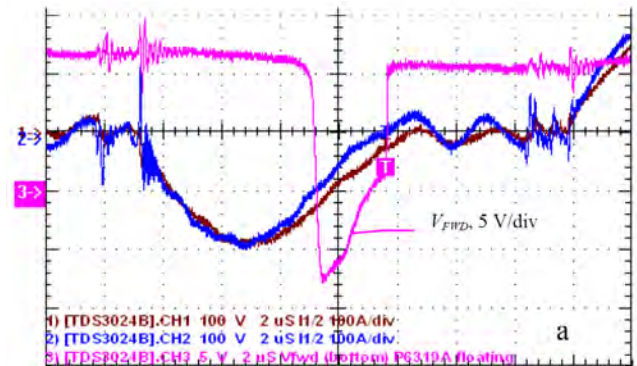

Fig. 11. Trace 3 - Forward drop of FWD IXYS DSEI 2x 61, two modules in parallel. a – high-bandwidth P6139A probe, b - differential probe. Both measurements taken with floating scope.

FLOATING OR DIFFERENTIAL MEASUREMENTS?

SAFETY ISSUES

As a rule, the scope chassis is grounded for safety, and floating measurements are performed with differential probes as recommended by scope vendors (see, e.g., [2]). Our experience shows, however, that the quality is severely compromised compared to the case when the scope is floating together with the reference point, e.g., the transistor emitter or the FWD anode. Examples of using a differential probe P5200 for V_{ce} and FWD forward drop measurement are shown in Fig. 10, Fig. 11, respectively.

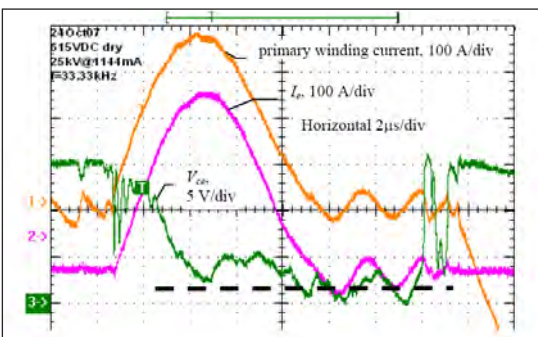

Fig. 10. Differential measurement of V_{sat} (trace 3 V_{ce}) of CM300DC-24NFM Powerex IGBT using circuit Fig. 4. Trace 3 may have some offset, likely zero is shown by dashed line.

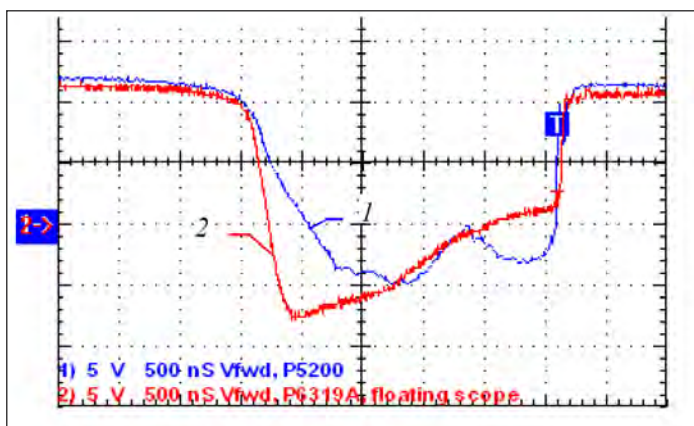

Fig. 12. Superposition of differential and floating measurements of Fig. 11a, b.

CONCLUSION

Divider Fig. 4 is recommended for the measurement of the on-state voltage of large power switches. Clamping voltage should be adjusted to the expected on-state value using proper number of zener diodes. Floating measurements provide better accuracy, however, safety rules should be strictly observed.

ACKNOWLEDGMENT

The authors acknowledge the support of this work given by Spellman High Voltage Electronics Corporation.

REFERENCES

- 1.) C. Huang, P. Melcher, G. Ferguson and R. Ness, "IGBT and Diode Loss Measurements in Pulsed Power Operating Conditions", Proc. Power Modulator Symposium, 2004, pp. 170-173.
- 2.) S. Gupta, Power Measurements and Analysis: Challenges and Solutions, Tektronix White Paper.
- 3.) A. Calmels, "VDS(on), VCE(sat) Measurement in a High Voltage, High Frequency System", Advanced Power Technology, Application note APT0407, November 2004.
- 4.) http://www.pemuk.com/pdf/cwt_mini_0605.pdf

Highly Efficient Switch-Mode 100kV, 100kW Power Supply for ESP Applications

Alex Pokryvailo, Costel Carp and Cliff Scapellati
Spellman High Voltage Electronics Corporation

Presented at 11th Int. Conf. on Electrostatic Precipitation, Hangzhou, 21-24 Oct., 2008, pp. 284-288.

ABSTRACT

For nearly a century, electrostatic precipitators (ESP) were driven by line-frequency transformer-rectifier sets. The last decade has been marked by steady penetration of high-frequency HV power supplies (HVPS) that offer considerable benefits for the industry.

This paper describes a novel concept and physical demonstration of an ultra-high efficiency, small size and low cost HVPS specifically designed for ESP and similar markets. Key technology includes a modular HV converter with energy dosing inverters, which operate at above 50kHz with and have demonstrated an efficiency of 97.5% in a wide range of operating conditions. The inverters' output voltages are phase-shifted, which yields an exceptionally low ripple of 1% and a slew rate of 3kV/ μ s combined with low stored energy. Modular construction allows easy tailoring of HVPS for specific needs. Owing to high efficiency, small size is achieved without turning to liquid cooling. Controls provide standard operating features and advanced digital processing capabilities, along with easiness of accommodating application-specific requirements.

HVPS design and testing are detailed. Experimental current and voltage waveforms indicate virtually lossless switching for widely-varying load in the full range of the line input voltages, and fair agreement with simulations. Calorimetric measurement of losses indicates to a >98.5% efficiency of the HV section. The overall efficiency is 95% at full load and greater than 90% at 20% load, with power factor typically greater than 93%.

KEYWORDS

Electrostatic Precipitator, ESP Power Supplies, High-Frequency Power Supplies, voltage multiplier

INTRODUCTION

For nearly a century, ESPs were driven by line-frequency transformer-rectifier sets. The last decade has been marked by a steady penetration of high-frequency HV power supplies (HVPS) that offer considerable benefits for the industry: small size, low ripple, fast response, etc., facilitating better collection efficiency. A good overview is provided by [1], [2]. It was noted that Alstom and NWL lead the market with hundreds of fielded units. Between other

developments, work of Applied Plasma Physics [3], Genvolt [4], VEI [5] should be mentioned.

High conversion frequency, typically 20-25kHz facilitates the size reduction. As noted in [2], the HV transformer of the Alstom SIR weighs about 22 lb, or 1/15 of that for a 60Hz power supply. Other passive components are shrunk respectively.

Heat management is one of the main issues for reliability. It is done by air-cooling (NWL) or liquid cooling (Alstom). It should be noted that air-cooling schemes seem to be preferential in this industry. In order to realize high efficiency, almost universally, the converter part of the above HVPS makes use of series resonance to avoid switching losses. The theory and practice of such converters is known well [6], [7]. A natural way for the voltage/current adjustment in such converters is frequency regulation. Audio noise is not an issue for the ESP and similar applications.

This paper describes a novel concept and physical demonstration of an ultra-high efficiency, small size and low cost HVPS specifically designed for ESP and similar markets.

MAIN SPECIFICATIONS

- 1.) Average output power 100kW in the output voltage range of 90-100kV; derated at lower voltage
- 2.) High frequency ripple component: 1% typically at 100kV, full power.
- 3.) Dynamic Response: slew rate 100kV/ms min (5% to 9 5% of preset voltage). Typically 300kV/ms
- 4.) Output Stored Energy: < 10 J.
- 5.) Conversion frequency 50kHz
- 6.) Input Voltage: Three Phase 400VAC +10%, -14%
- 7.) Power Efficiency: typically > 95% at full power at 100 kV, > 90% at 20kW.
- 8.) Power factor: > 93% at full power at 100kV, > 75% at 20kW.
- 9.) SPARK/ARC WITHSTAND
- 10.) Overall weight 250kg TBD; HV unit 109kg (240 lbs); Oil volume less than 60 liter

TECHNICAL ARTICLES ABOUT HVPS and HV ELECTRONICS

Research Papers

KEY TECHNOLOGY

The HVPS is built around a modular HV converter (Figure 1). All converter modules M1-MN are fed from a common Input Rectifier (IR). The modules comprise inverter INV1-INVN feeding HV transformers T1-TN that feed voltage multipliers R1-RN, which voltages are summed by their DC outputs. Such topology may be termed as “inductive adder”. For the 100kV, 100kW rating N=4. Each module is built for 25kV, 25kW average power and must have high potential insulation of the secondary winding of the transformer rated at $3 \cdot 25kV = 75kVDC$. This insulation must also withstand transient voltages arising during the HVPS turn-on and turn-off. The number of such transients is determined by the HVPS operating scenario, and mainly by the sparking rate.

The topology Figure 1 was investigated long ago. It allows reduction both of the number of the multiplier stages and the voltage rating of the HV transformer. The first improves the compression ratio and reduces drastically the stored energy. Phase shift of the inverters’ outputs voltages results in the decrease of the output ripple and in additional reduction of the stored energy. In this approach, the development costs and time are driven down noting that once a single module has been developed (including its main insulation), the whole system is realized by a simple combination of the desired number of modules. The penalty is larger part count and the necessity of high-potential insulation that is not required in conventional Cockcroft-Walton multipliers. However, this insulation is subjected mainly to DC stresses and therefore ages much slower compared to an AC stress.

The converter cells are centered around half-bridge energy dosing quasi-resonant inverters (Figure 2) [10], [11], [12]. The principle and theory of operation were put forward in [11]. In normal mode, one of the divider capacitors, C_{div} , is charged to the rail voltage. When the corresponding switch closes, it discharges through the primary, while its counterpart recharges to the rail voltage. If the current path contains an inductance, a sine waveform is generated, and ideally, all the energy stored in C_{div} would be transferred to the secondary side. If C_{div} discharges fully, and the current does not fall to zero, the free-wheeling diodes (FWD) across the capacitors clamp the current preventing the voltage reversal. Thus, the remainder of the energy stored in the circuit inductance is transferred to the output (see also Figure 4). The benefits of this topology are tight control of the energy transfer and inherent limitation of the short circuit current and voltages across the converter components.

The maximum frequency, at which the operation is possible with zero-current crossing (ZCC), in a normalized form, is given by the equation

$$f_N = \frac{1}{\frac{2}{\pi} \left[\frac{1}{2} a \cos\left(\frac{V_l}{V_l - E}\right) + \frac{E}{2V_l} \sqrt{1 - \frac{2V_l}{E}} \right]}$$

where E is the rail voltage, and both the rail voltage and the load voltage V_l are referenced to the same side of the transformer. The conversion frequency f is normalized to the resonant frequency f_0 of the loop formed by the leakage inductance and resonant capacitors:

$$f_N = J / f_0$$

A sample plot of this equation is shown in Figure 3. It should be noted that the real conversion frequency is somewhat lower to allow a deadtime of $\sim 1.5\mu s$.

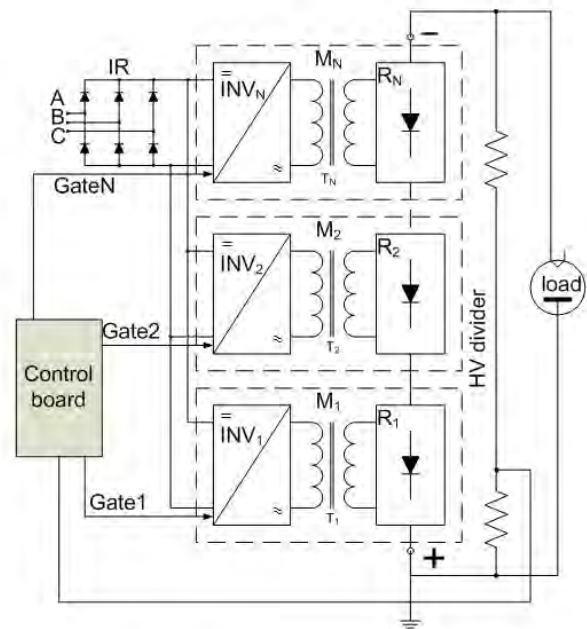

Fig. 1. HVPS block-diagram.

TECHNICAL ARTICLES ABOUT HVPS and HV ELECTRONICS

Research Papers

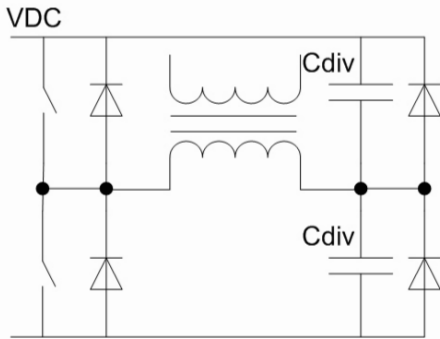

Fig. 2. Inverter with energy dosing capacitors

The inverters operate at approximately 50kHz at full load with virtually zero switching losses. The leakage inductance of the HV transformers is fully incorporated into the resonant tank circuits, so no external inductors are necessary. Besides lowering the part count and cost, this feature is highly beneficial for the chosen multicell resonant topology, since leakage inductance is well repeatable from sample to sample and does not depend on temperature. Controls provide standard operating features and advanced digital processing capabilities, along with the easiness of accommodating application-specific requirements. The output regulation is accomplished by the frequency control.

EXPERIMENTAL

Single module

Typical waveforms shown in Figure 4 (taken at nominal line) indicate good resonant switching with no shoot-through currents in the full range of the line input voltages, and fair agreement with PSpice simulations. The primary winding was divided into two sections connected in parallel, each commutated by a transistor set, hence the notation “halved” in the figure caption. The dashed line shows the start of the FWD conduction. At low line, the FWDs do not conduct, and the converter operates in a boundary mode given by (*). These measurements were conducted with the Powerex IGBTs CM300DC-24NFM. The power losses were assessed at 50W per transistor (four transistors, or 800W per converter module), and the heat was easily evacuated using air-cooled heatsinks with overheat above ambient of less than 40°C. The methods of power loss measurement are detailed in [13].

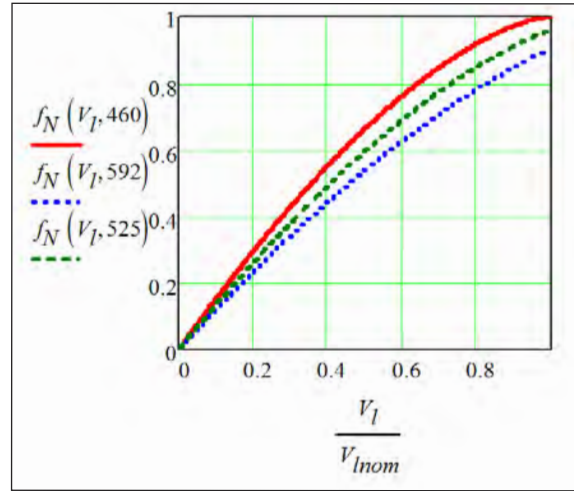

Fig. 3. ZCC curves for low (460V), high (592 V) and nominal (525V) DC rail voltages. V_{lnom} is nominal load voltage.

Special attention was paid to the determination of the HV transformer and multiplier losses. This was key to the design of the HV tank. With this purpose, calorimetric measurements of the losses were performed. They yielded a figure of 344W, with 175W attributed to the transformer losses, and the rest to the multiplier losses. Thus, the efficiency of the HV section was expected to be >98.5%. Accounting also for the inverter losses, the converter efficiency was estimated at 97.5%, so the overall efficiency of 95% of the whole HVPS was projected. In view of the expected high efficiency, it was decided to adopt an air-cooling scheme.

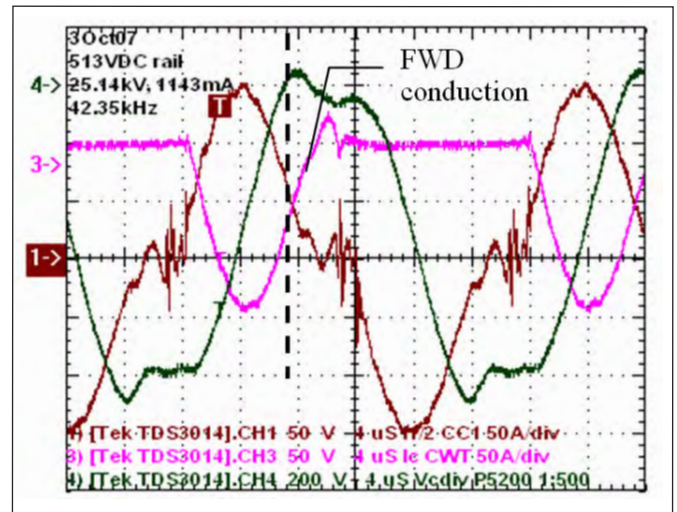

Fig. 4. Nominal line. P=28.7kW. trace 1 – primary winding current (halved); trace 3 – collector current (halved); trace 4 – voltage across resonant capacitors. FWD conduction to the right of dotted line.

TECHNICAL ARTICLES ABOUT
HVPS and HV ELECTRONICS
Research Papers



Fig. 5. Laboratory HVPS.

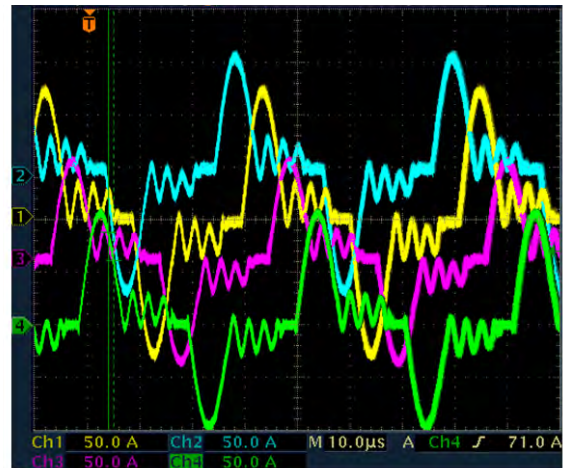

Fig. 7. Same as in Figure 6 at 100 kV@50 kW.
Low line 400 VAC-14 % (345 VAC).

HVPS Tests

A laboratory HVPS was assembled on a cart as shown in Figure 5. It comprises three main units: a circuit breaker protected line rectifier, an inverter section and an oil-filled HV tank. We note that in this work, the emphasis was on the converter part; the line rectifier was not optimized.

The HVPS was extensively tested with resistive loads. Figure 6 and Figure 7 show typical phase-shifted primary windings currents (halved) for 100kW and 50kW operation, respectively. The oscillations after the main current surge are generated by the resonance between the leakage inductance and parasitic capacitance of the transformers. Note the absence of the “backswing” current pulse characteristic for the series resonant schemes under light load.

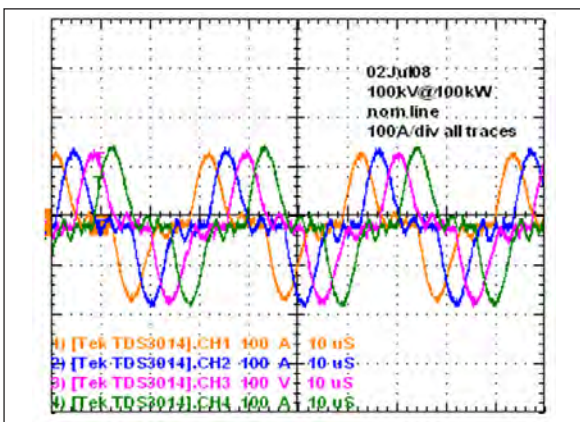

Fig. 6. $\pi/4$ -phase-shifted primary windings currents (halved) at 100kV@100kW. Nominal line voltage 400 VAC.

Since the full-wave rectification scheme is used, the phase shift is $\pi/4$. PSpice calculations predict 0.223% output voltage ripple peak-to-peak (p-p) with the HVPS shock capacitance of $<2nF$ (Figure 8) at the worst case of high line; the measured ripple is roughly four times larger, and has a lower frequency fundamental component (Figure 9), which can be attributed to the asymmetry of the gate signals, unequal parasitic capacitances, spread in winding data, etc. Similar effect was observed in [9]. These simulations provide also a value of the Power Factor (PF) of 0.943, which is close to the experimental results.

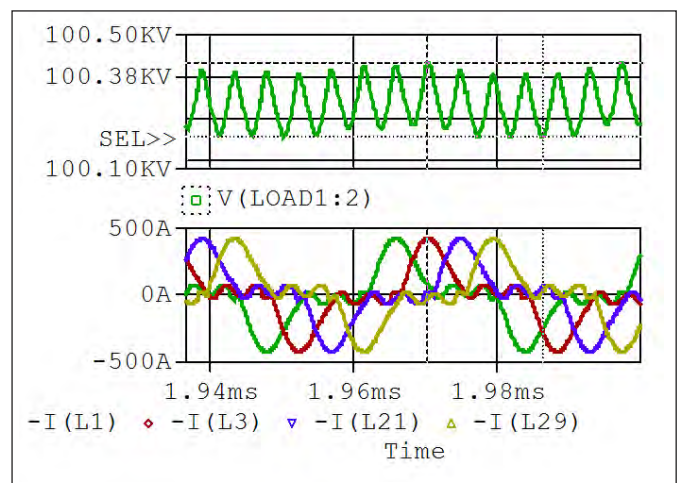

Fig. 8. HVPS circuit simulation. High line 580V. ripple 0.223% p-p. PF=0.943. Experimental PF= 0.946 (see Figure 11).

TECHNICAL ARTICLES ABOUT HVPS and HV ELECTRONICS

Research Papers

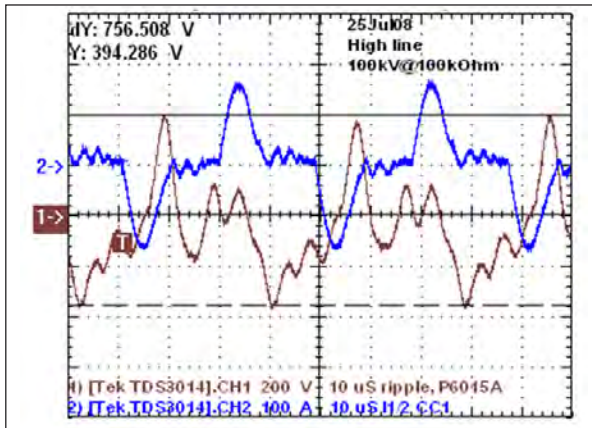

Fig. 9. Ripple at 100 kV across 100-kΩ load is 0.762 % p-p.

The dynamic response of the HVPS is exceptionally fast: the risetime from zero to full output voltage is typically less than 250μs (Figure 10), depending on the line voltage. With fair accuracy, the dynamic characteristics can be analyzed using the equation

$$V_L(t) := 2 \cdot V_{rail} \sqrt{\frac{C_{div}}{C_s} \cdot f \cdot t}$$

where all the variables and parameters are reflected to the same side of the transformer; Cs is the overall capacitance of the module multiplier. If the frequency is varied during the charge, PSpice simulations provide much better accuracy.

Fast response is beneficial not only for ESP but medical applications as well. We note that the risetime practically does not depend on the load, since the load current is by an order of magnitude smaller than the current charging the multiplier capacitors.

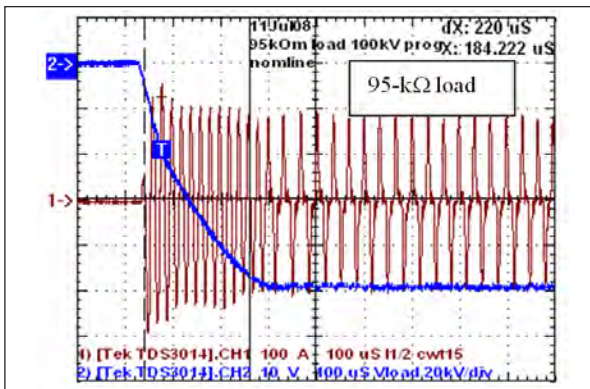

Fig. 10. Risetime across 95kΩ load at nominal line. Trace 2 – load voltage, 20kV/div; trace 1 – primary current (halved), 100 A/div.

Figure 11 presents experimental data on the power measurements obtained at nominal line. In accordance with the simulations and information derived from the work with sin-

gle module, the overall efficiency is 95% at full load and greater than 90% at 20% load. The power factor was also satisfactorily high (compare to the simulation Figure 8). At high and low line, the measurements yielded very similar results. At higher resistance load, the efficiency and PF also stayed high (Figure 12).

At the time of writing this paper, long-term runs at 100kV have been performed up to a power level of 75kW. Full-power tests were limited to ~40 min. They showed conservative overheat of the major HVPS components. For the nominal line, the results are summarized in Table 1.

load power, kW	transistor baseplate	FWD baseplate	HV tank
75	20	18	27
100	25	23	N/A

Table 1. Overheat of major HVPS components, °C.

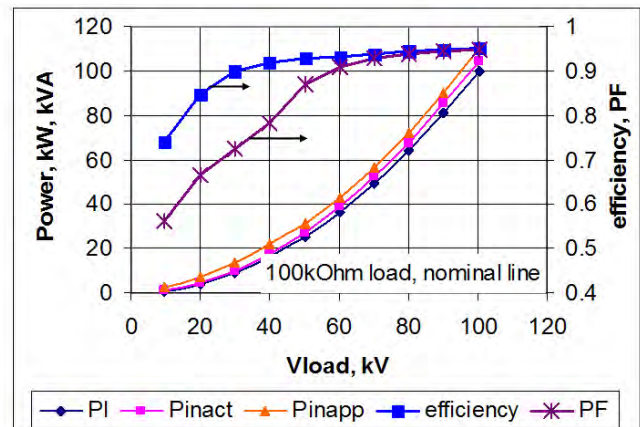

Fig. 11. Apparent, Pinapp, and active input power, Pinact, load power, PI, efficiency and PF at nominal line for 100kΩ load.

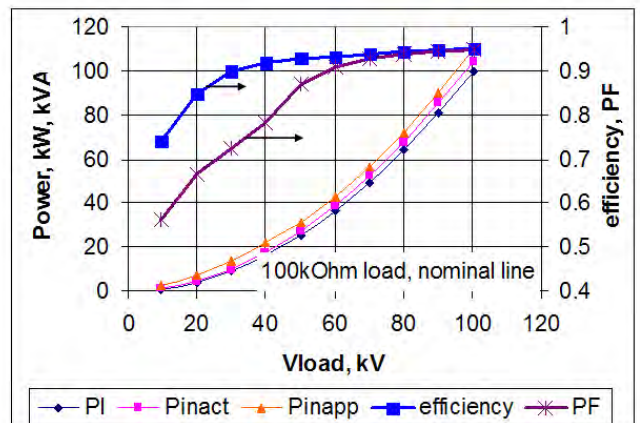

Fig.12. Same as in Figure 11 for 200kΩ load.

ACKNOWLEDGMENTS

The authors thank their colleagues at Spellman for massive support of this work, and especially Mr. A. Lipovich for his contribution to the mechanical design, and Mr. A. Silverberg for the realization of the phase-shift algorithm.

REFERENCES

- 1.) K. Parker, 'Electrical Operation of Electrostatic Precipitators', IEE, London, 2003, 270pp.
- 2.) Advanced Electrostatic Precipitator (ESP) Power Supplies Update: The State-of-the-Art of High-Frequency Power Supplies. EPRI, Palo Alto, CA: 2006. 1010361.
- 3.) M. K. Kazimierczuk, D. Czarkowski, "Resonant Power Converters", Wiley, NY, 1995.
- 4.) R. Erickson and D. Maksimovic, "Fundamentals of Power Electronics" (Second Edition), Springer, NY, 2001, 912pp.
- 5.) US Patent 4,137,039, "X-Ray Diagnostic Generator", Feb. 23, 1982.
- 6.) Yu. Petrov and A. Pokryvailo, "HV DC-to-DC Converter", Pribory i Tekhnika Experimenta, v.2, pp. 141-143, 1986, Translation to English Plenum Publishing Corp.
- 7.) B.D. Bedford and R.G. Hoft, 'Principles of Inverter Circuits', Wiley, NY, 1964.
- 8.) B. Kurchik, A. Pokryvailo and A. Schwarz, "HV Converter for Capacitor Charging", Pribory i Tekhnika Experimenta, No. 4, pp.121-124, 1990, Translation to English Plenum Publishing Corp.
- 9.) M. Wolf and A. Pokryvailo, "High Voltage Resonant Modular Capacitor Charger Systems with Energy Dosage", Proc. 15th IEEE Int. Conf. on Pulsed Power, Monterey CA, 13-17 June, 2005, pp. 1029-1032.
- 10.) A. Pokryvailo and C. Carp, "Accurate Measurement of on-State Losses of Power Semiconductors", 28th Int. Power Modulators Symp., Las Vegas, 27-31 May, 2008.

High-Power, High-Performance, Low-Cost Capacitor Charger Concept and Implementation

Alex Pokryvailo, Senior Member, IEEE, Costel Carp, Member, IEEE and Cliff Scapellati, Member, IEEE

Abstract—A 20-kJ/s 10-kV 1-kHz repetition rate capacitor charger design and testing are described. The goal of the development was to combine high performance and versatility with low-cost design and good manufacturability. This goal was met using an energy-dosing converter topology with smart controls adapting the switching frequency in such a way as to ensure zero-current switching for all possible scenarios, keeping maximum duty cycle for high power. The switching is accomplished at a frequency of up to 55 kHz, employing relatively slow insulated-gate bipolar transistors with low conduction losses. High efficiency allows all-air cooled design that fits into a 19" × 10" × 24" rack. Design guidelines are reviewed. Comprehensive PSpice models accounting for numerous parasitic parameters and mimicking controls for the frequency variation were developed and simulation results are presented. Worst-case repeatability analysis has been performed. Both PSpice simulations and analytical tools predicted pulse-to-pulse repeatability of 0.3%; the measured figures are 0.8% and 1% for short- and long-term operations, respectively, at peak charging and repetition rates. Typical current and voltage traces and results of thermal runs are presented.

Index Terms—Capacitor charging, power conditioning, power electronics, pulsed power, pulse-to-pulse repeatability (PPR).

I. INTRODUCTION

CAPACITOR chargers are ubiquitous in industry, science, and healthcare. The list of applications associated with pulsed power is very long and ever expanding; the reader may consult relevant sources [1], [2].

Switch-mode power supplies (PSs) almost universally superseded line-frequency PS in capacitor charging. For charging rates above several kJ/s, soft-switching topologies prevail [3]–[9], at least in commercial products (see, e.g., papers from General Atomics [3] and Lambda [4]). Series-resonant topologies seem to dominate this niche. PSs based on these topologies act as a constant current source, and as such are advantageous in limiting the inrush current and protecting the load. With constant current, the charge voltage grows linearly, and thus the charge power is a linear function of time.

Between numerous applications, a combination of high voltage, high charging rate (tens of kJ/s and higher), high pulse repetition rate (PPR), compactness, high efficiency, and good pulse-to-pulse repeatability (PPR) is most difficult. Putting constraints of low-cost and good manufacturability makes the

charger development even more challenging. They restrict use of costly custom-made components, fast switches (e.g., wideband gap devices or stacks of fast MOSFETs), exotic cooling schemes and materials (heat pipes, fluorocarbon low-temperature boiling liquids, polymers with nanofillers), leaving relatively few degrees of freedom, such as choice of proper circuit topology and control strategy to increase the switching frequency with the purpose of shrinking the size and improving PPR.

PPR, denoted further as R , is an important parameter in capacitor charging. It influences the stability of various physical processes ranging from lasing to pulsed microwave and X-ray radiation to plasma chemistry applications.

PPR can be defined as

$$R = \frac{V_{C\max} - V_{C\min}}{V_{C\text{avg}}} \cdot 100\% \quad (1)$$

where $V_{C\max}$, $V_{C\min}$ and $V_{C\text{avg}}$ are the maximum, minimum, and average values of the voltage across the storage capacitor C_s for a batch of pulses.

Usually, the charging does not involve predictive algorithms. This means that when the output voltage reaches the programmed value, the inverter is shut down. At this moment, the converter components, e.g., the leakage inductance of the HV transformer, store remnant energy E_{rem} that is commensurable with energy portions transferred to C_s every cycle. Then, the output overshoots because E_{rem} may flow wholly or partially to the storage capacitor. This is one of the main factors degrading PPR. In fact, it seems to be the only factor discussed in literature. It might seem that the repeatability can be estimated easily, assuming that all this energy can be transferred to C_s ; then, R would be proportional to E_{rem} . More precisely, it can be given by the formula (see the Appendix)

$$R = \left(\sqrt{1 + \frac{E_{\text{rem}}}{E_c}} - 1 \right) \cdot 100\% \quad (2)$$

where E_c is the energy stored in C_s . Application notes from ALE [10] and General Atomics [4], [11] provide similar simplistic estimates. In scientific experimentation, it is common to set the charge voltage at a fraction of the charger rated voltage and/or charge small capacitors. Then, the charge can be accomplished during even less than a half-cycle of the conversion frequency [see Figs. 7 and 15(a)], which means that E_{rem} is comparable with E_c . Assuming that $E_{\text{rem}} = E_c$, we calculate $R = 41.4\%$. If it takes two cycles to reach the maximum charge voltage, we can assume that $E_{\text{rem}} = 0.25E_c$, which yields

Manuscript received September 14, 2009; revised March 14, 2010; accepted May 27, 2010. Date of publication September 13, 2010; date of current version October 8, 2010.

The authors are with the Spellman High Voltage Electronics Corporation, Hauppauge, NY 11788 USA (e-mail: Apokryva@spellmanhv.com).

Color versions of one or more of the figures in this paper are available online at <http://ieeexplore.ieee.org>.

Digital Object Identifier 10.1109/TPS.2010.2051959

TECHNICAL ARTICLES ABOUT
HVPS and HV ELECTRONICS

Research Papers

TABLE I
MAIN SPECIFICATIONS

Input Voltage	400 VAC or 480VAC ^{+10%} _{-14%} , 3Φ 50/60 Hz, 4 wire, frequency ± 2%
Output Voltage	0 to 10 kV
Average Charging Rate	20 kJ/s
PRR	Single shot to 1 kHz
Efficiency	>92 % at full charging rate, >85 % at 30 % of rated power
Power factor	>0.93 at full charging rate >0.85 at 30 % of rated power
Pulse to Pulse repeatability	Better than 1% at 1 kHz@10 kV, long-term Better than 0.8% at 1 kHz@10 kV, short-term Better than 2% at 1 kHz@2 kV-10 kV, short-term.
Insulation	Air, 10 kV and below
Size	10½" (6U)H x 19"W x 24"D rack mount
Weight	90 lb (41 kg)
Cooling	Air

$R = 11.8\%$ (see Fig. 20); in reality, the repeatability may be not that bad.

Much effort was put to improve PPR, particularly at high PRR. A common approach is decreasing the rate of charge by an order of magnitude or so toward the end-of-charge (EOC). Thus, the charge buckets (using the terminology of [4], [10]) carried in each period are smaller, and the energy delivery to the storage capacitor can be controlled tighter. This technique in various implementations is used in commercial products (see, e.g., [3], [4], [12]). The shortcoming of such an approach is overrating the charger power, since the bulk high-power charge occurs at a low duty cycle, fine charging capturing 10–30% of the charge cycle [3].

This paper describes the development and testing of a high-power charger satisfying the aforementioned contradicting requirements within the constraints of a low-cost proven technology. A focus is made on the theoretical and experimental investigation of PPR. In this paper, the latter was studied at bulk charge only.

II. MAIN SPECIFICATIONS

This section summarizes in Table I the salient features and the most important technical parameters of the developed charger.

III. DESIGN

A charger block diagram is shown in Fig. 1. The charger is comprised of a 3-phase input rectifier with a circuit breaker, a soft-start means and a smoothing filter, a converter module (CM), and an HV divider and control means. Triggered by an external source, the charger charges capacitor C_s that is discharged onto a dummy load via a high-power switch DS_w. Limiting inductors and/or resistors may be added as needed.

The CM is comprised of an inverter INV, an HV transformer wound on popular U100/57/25 ferrites, and a rectifier R. The CM's heart is a halfbridge quasi-resonant inverter

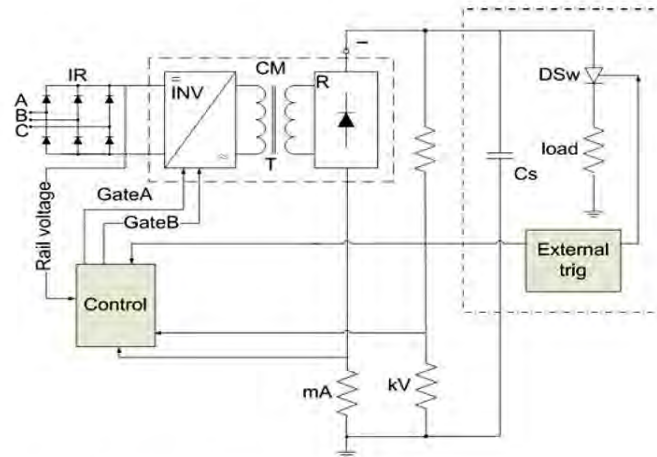

Fig. 1. Charger block diagram.

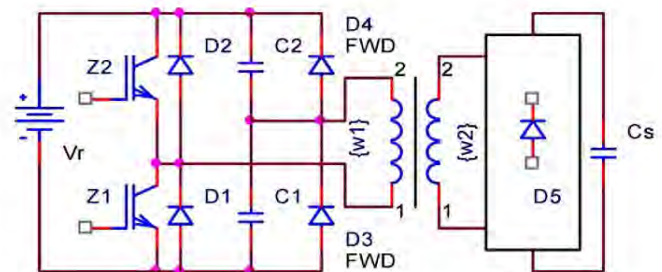

Fig. 2. Halfbridge inverter with energy dosing capacitors. Transformer is actually comprised of two transformers, whose primaries are connected in parallel and secondaries in series.

with energy-dosing capacitors (Fig. 2) [14]–[16]. Work [15] provides the principle and theory of operation (its content is partially reiterated, cleaned of misprints, and expanded in this section and in the Appendix). In normal mode, one of the resonant capacitors, C1, C2, is charged to the rail voltage V_r . When the corresponding switch closes, the resonant capacitor discharges through the primary winding, while its counterpart recharges to the rail voltage (see also timing diagrams Fig. 21). If the current path contains an inductance, a sine waveform is generated, and, ideally, all the energy stored in both resonant capacitors is transferred to the secondary side. If the resonant capacitor discharges fully but the current does not fall to zero, the freewheeling diode (FWD), which is connected in parallel to the capacitor, conducts, acting as a clamp and preventing voltage reversal. Thus, the remainder of the energy stored in the circuit inductance is transferred to the output. The benefits of the energy-dosing are tight control of the energy transfer and inherent limitation of the short-circuit current and voltages across the converter components.

The maximum frequency, at which the operation is possible at a certain load voltage V_l with zero-current crossing (ZCC), in a normalized form is given by [15]

$$f_N(V_l, E) = \frac{1}{\frac{2}{\pi} \left[\frac{1}{2} a \cos \left(\frac{V_l}{V_l - E} \right) + \frac{E}{2V_l} \sqrt{1 - \frac{2V_l}{E}} \right]} \quad (3)$$

TECHNICAL ARTICLES ABOUT
HVPS and HV ELECTRONICS
Research Papers

Fig. 3. ZCC curves for low (460 V), high (592 V), and nominal (525 V) dc rail voltages. V_{inom} is nominal load voltage.

where E is the rail voltage, and both the rail and the load voltages are referenced to the same side of the transformer. The conversion frequency f is normalized to the resonant frequency f_0 of the loop formed by the leakage inductance and the resonant capacitors; $f_N = f/f_0$. A sample plot of this equation is shown in Fig. 3.

Since energy dosing is implemented, the charging power P is proportional to conversion frequency

$$P = 2C_r V_r^2 f$$

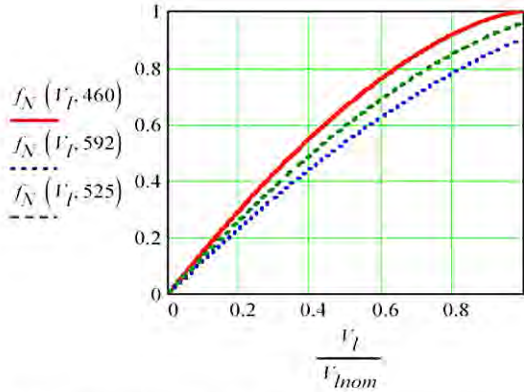
where C_r is the capacitance of the resonant capacitors C1 and C2. The load voltage can be calculated as [15]

$$V_l = 2E \sqrt{\frac{C_s}{C_r} f t}. \quad (4)$$

Although P cannot be expressed as an explicit function of time, the time to charge to a specified load voltage t_{ch} can be. Combining (3) and (4), we obtain in a normalized form

$$t_{chN} = \frac{C_s \pi V_l^2 \left[1 - a \cos\left(\frac{V_l}{E - V_l}\right) \right] + E V_l \sqrt{\frac{E - 2V_l}{E}}}{4\pi E^2} \quad (5)$$

where $t_{chN} = t_{ch} f_0$.

Using (5) and recognizing that the charging power $P = (d/dt)(C_s V_l^2 / 2)$, we can plot the load voltage, charging power, and frequency versus time, as shown in Fig. 4, in a normalized form. It can be seen that the power is not increasing linearly as in the systems with constant current charge but rather saturating to EOC. There are two implications to this end: 1) the charge can be accomplished faster, at a price of some overloading of the converter components at start of charge (about 50% higher start currents, albeit at a lower frequency—Figs. 6 and 11); and 2) lower energy/charge bucket delivered to the storage capacitor at EOC, which is beneficial for PPR. A detailed comparison of the two charge methods is, however, beyond the scope of this paper.

The field-programmable-gate-array-based controls are characterized by their flexibility ensuing from programming and digital processing capabilities. The standard features include multiple protections (short circuit, overheat, overcurrent, and overvoltage, arc, etc.,) and means of voltage and current setting.

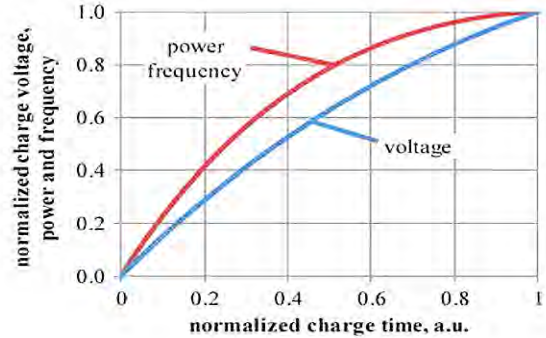

Fig. 4. Time dependence of load voltage, charging power, and frequency at ZCC.

Via a firmware, an algorithm realizing (3) is implemented. It adapts the switching frequency from 12.5–55 kHz, in such a way as to ensure zero-current switching (ZCS) for all possible scenarios, keeping maximum duty cycle for high power. Thus, the switching losses are virtually non-existent, which allows using relatively slow inexpensive semiconductor switches both on the primary and secondary sides.

A precision feedback divider was designed for high-fidelity measurements necessary for maintaining good PPR. A risetime of less than 1 μ s and low temperature drift were realized.

The packaging was made in a 19" rack-mounted chassis, 10 1/2" tall, 24" deep. The parasitics of the HV transformer together with the capacitors C1, C2 are integrated into the resonant tank circuit, so no external chokes are needed. The circuit breaker and an HV connector are mounted on the rear panel. On the front view [Fig. 5(a)], the front panel borrowed from the Spellman SR6 series [17] is seen. The unit is equally divided by height into two sections. The upper half houses a conservatively designed input rectifier with the circuit breaker, EMI filters and soft start components, and the inverter. HV components, a housekeeping power supply, and the filtering electrolyte capacitors of the input rectifier are located in the bottom half [Fig. 5(b)]. The control board is mounted on the front panel. Owing to high efficiency (see Section V-C), all-air cooling is feasible.

Comprehensive PSpice models accounting for numerous parasitic parameters and mimicking controls for the frequency variation were developed, assisting in both the design and interpretation of the experimental data. A sample of the simulated waveforms is given in Fig. 6 for the cases of low and high line voltages. With the purpose of shortening the computation time and for clearer graphical presentation, in these simulations, C_s was 200 nF, approximately half of that used in the experiments. It is seen that, at any moment (except the first pulse that is chopped intentionally) during the charging cycle, ZCS is attained. This was confirmed experimentally (see Section V-B).

IV. REPEATABILITY ANALYSIS

Pulse-to-pulse *variability* evolves from several factors.

- 1) Converter remnant energy E_{rem} at EOC. E_{rem} may flow wholly or partially to the storage capacitor, so the output voltage will be higher than the programmed value.

TECHNICAL ARTICLES ABOUT HVPS and HV ELECTRONICS

Research Papers

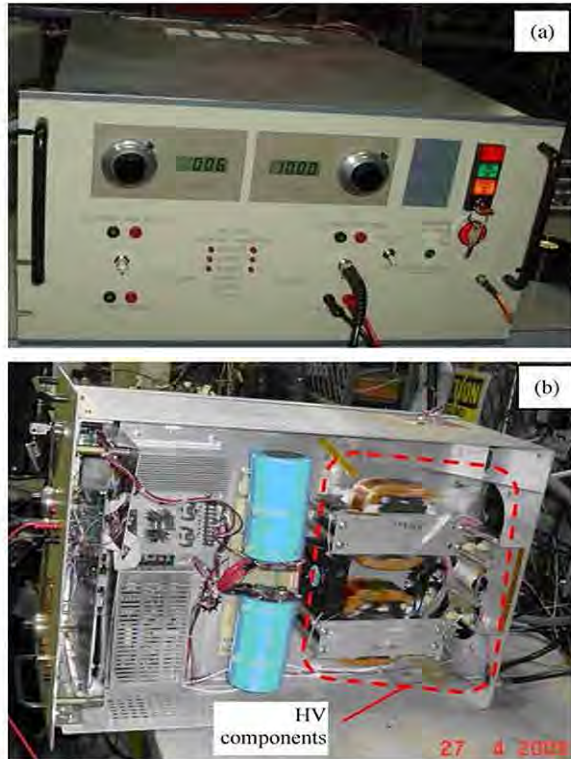

Fig. 5. Charger (a) front view and (b) bottom section.

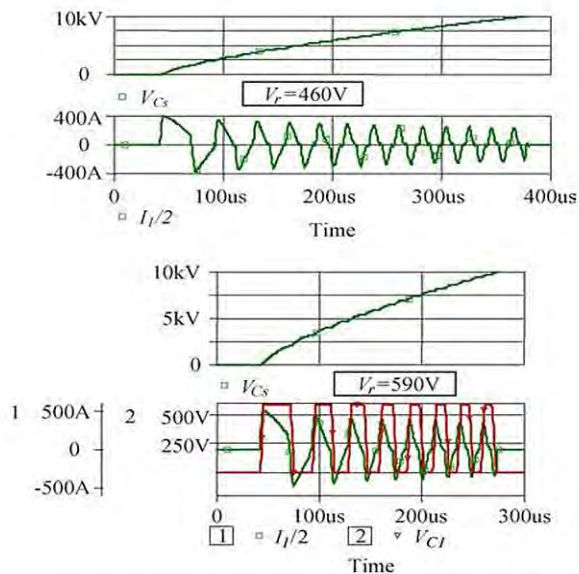

Fig. 6. PSpice simulation for 460 V and 590 V dc rail voltage. Parameters correspond to those of physical object (leakage inductance is $L = 3.3$ mH, reflected to secondary; $C1 = C2 = 2$ μ F is resonant capacitor, $C_s = 200$ nF is the storage capacitance). Primary current I_1 is halved.

- 2) Error in generating EOC signal. This may be caused by a poor-quality feedback, noise, unstable reference voltage, etc.

- 3) Delay t_d between the EOC and the actual insulated-gate bipolar transistor (IGBT) turn-off. It comprises digital delays, optocouplers delay, and the IGBT turn-off delay. Even constant t_d , if commensurable with half-period, affects PPR. Depending on the circuitry and the components, t_d can be fractions of a microsecond, i.e., t_d is a good part of the half-period.

The open literature cites factor 1 only as detrimental to PPR. However, factor 2 can be quite as important. A rule of thumb is that, in relatively low-voltage applications and low-noise environment, and charge intervals comprising just a few cycles of conversion frequency, factor 1 dominates. On the contrary, at high voltage in a noisy environment and long charge, factor 2 would dominate. In the present work, factor 2 accounts for roughly 60% of the pulse-to-pulse variability at the maximum charge voltage. Quantifying further the influence of the cited factors is beyond the scope and means of this paper.

It is logical to assume that E_{rem} , on the average, is proportional to the rail voltage squared, and E_{rem} depends upon the value of the primary/secondary current at EOC. With our broad definition, E_{rem} can be stored anywhere in the system: in the leakage and magnetizing inductances and parasitic capacitance of the HV transformer and rectifier, in the parasitic inductances of the busbars and connections, etc. For the sake of simplicity, we disregard factors 2 and 3 and will limit the analysis to the case of E_{rem} stored in the leakage inductance only.

In the circuit in question, E_{rem} flows not only into C_s , but is recovered partially in the dc rail power supply and, depending on the initial conditions (IC), may be directed to the resonant capacitors $C1$, $C2$; part of it is lost in the form of heat. Upon the transistor opening at EOC, if the corresponding resonant capacitor is not fully discharged (mode 1), with reference to Fig. 2, the transformer current flows along the following loops (we have chosen arbitrarily the bottom switch as the conducting one): positive terminal of $C1$, HV transformer, HV rectifier $D5$, C_s , FWD $D2$, V_r , returning to $C1$. The FWD current is split in two, half of it recharging one of the divider capacitors $C2$. If FWD parallel to $C1$ conducts at EOC (mode 2), the current loop does not include $C1$, but closes through $D3$. There also can be a transition from mode 1 to mode 2.

Sample PSpice waveforms for a low charge voltage of 2 kV (the charger is rated for 10 kV) are shown in Fig. 7; they will be useful as an empirical guide for further analytical analysis. In this parametric run, the source of the variability was the dc rail voltage V_r , swept from 460–600 V in 20-V increments, which corresponds to common variations of a 400 VAC 3-phase line. EOC corresponds to the chopping of the primary winding current I_1 .

It is seen that the maximum overshoot takes place not at the maximum chopping current. Moreover, the same chopping current (same amount of energy stored in L_s) may result in very different overshoots depending on the EOC timing, as follows from the comparison of the first and the last curves ($V_r = 460$ V, $V_r = 600$ V, respectively). Calculating by (2), the overshoot ΔV above the programmed voltage of 2 kV, which would result from E_{rem} delivered wholly to C_s , we obtain $\Delta V \approx 450$ V. In this example, $E_{rem} = L_s I_1^2 / 2 = 0.2$ J for $I_1 = 500$ A corresponding to $V_r = 460$ V, $V_r = 600$ V. It

TECHNICAL ARTICLES ABOUT HVPS and HV ELECTRONICS

Research Papers

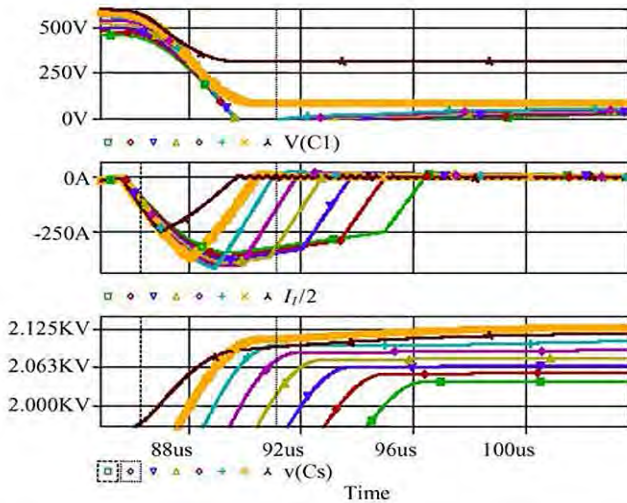

Fig. 7. Programmed charge voltage 2 kV. $V_r = 460\text{ V}, 480\text{ V}, \dots, 600\text{ V}$. $C_s = 200\text{ nF}$. Primary current I_1 is halved. Curves corresponding to largest overshoot are in thicker lines.

is seen that the overvoltages are much lower than the above estimates even at higher currents. Thus, only part of E_{rem} reaches C_s , the rest being recuperated mainly in the dc rail source. An additional observation is that the largest overshoot (lower graph Fig. 7, 2nd curve from the left) occurs when the resonant capacitor voltage does not reach zero.

Linearizing the circuit piecewise and using corresponding equivalent circuits (EC) allows full analytical description of the electromagnetic processes occurring after EOC; IC can be obtained from the equations derived in [15].

An analytical treatment is given in the Appendix. In this paper, it is limited to a worst case of EOC occurring at any time from the primary current onset to its maximum. Full rigorous analysis and a predictive control algorithm derived from it will be reported separately. For the converter parameters corresponding to our experimental setup and simulations¹, the repeatability R , is plotted in Fig. 8 versus EOC time t_c (subscript “c” stands for Chopping). The load voltage V_L serves as a parameter and is given as a fraction of the rail voltage; both V_L and V_r reflected to the same side of the HV transformer. Since a halfbridge is involved, the nominal load voltage is $V_L \approx V_r/2$ at low line. Considering V_r variation from 460 V (low line) to 590 V (high line), we note that the repeatability is worse at high line, whereas the nominal load voltage is $V_L = 10\text{ kV} \approx V_r/2 * 460/590 * k_{tr} = 0.39k_{tr}V_r$. The maxima of the curves indicate the worst case of the most unfavorable EOC timing and are plotted separately in Fig. 9 together with a plot of (2). It is seen that the overshoot derived empirically is by several times larger than that predicted by the rigorous analysis. Finally, Fig. 10 summarizes PSpice and analytical calculations and experimental results. The latter are described in more detail in Section V-D. Notably, the analytical curve lies very close to its PSpice counterpart, always above it, as it should, because the

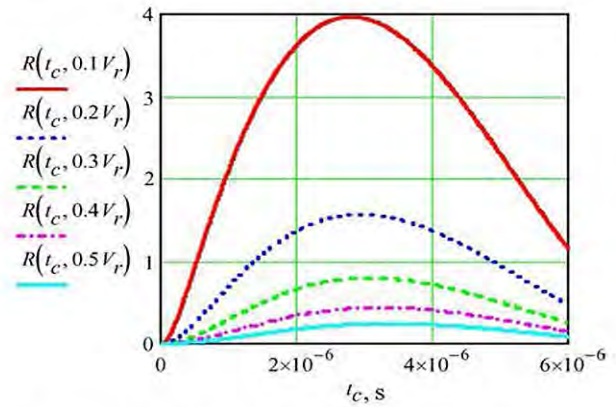

Fig. 8. Repeatability $R\%$ versus t_c , with load voltage V_L as a parameter (in fractions of the rail voltage, both reflected to the same side of HV transformer). Nominal load voltage (10 kV) is $V_L \approx V_r/2$ for low line ($V_r = 460\text{ V}$ at primary side). $C_s = 200\text{ nF}$, $C1 = C2 = 2\text{ }\mu\text{F}$. Compare to Fig. 7.

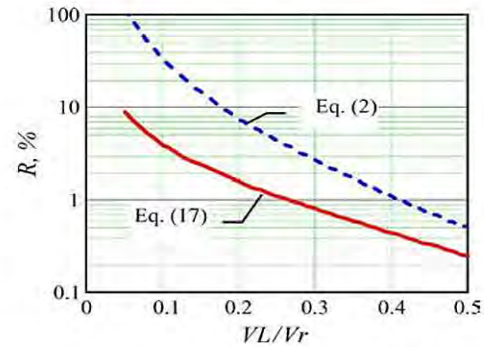

Fig. 9. Repeatability as a function of charge voltage, $C_s = 200\text{ nF}$, $C1 = C2 = 2\text{ }\mu\text{F}$, worst case.

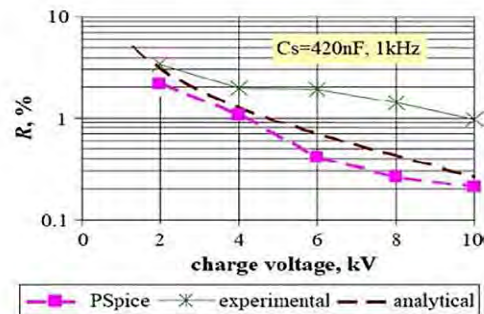

Fig. 10. Repeatability as a function of charge voltage—summary of PSpice and analytical calculations and experimental results.

PSpice parametric sweeps performed in 20-V V_r increments do not necessarily find precisely the worst-case EOC time.

V. EXPERIMENTAL

A. Measurement Means

For the measurement of the high-frequency current of the inverter components, Rogowski probes of PEM make, model CWT15, were used. The C_s voltage was measured by a

¹200 nF in simulations, 400 nF in experiments.

TECHNICAL ARTICLES ABOUT
HVPS and HV ELECTRONICS
Research Papers

Fig. 11. Typical waveforms at high line. PRR = 1400 Hz in burst, charge time is 507 μ s. (a) Load capacitor voltage and primary winding current. (b) Collector current.

Tektronix P6015A probe. Floating voltage measurements were performed by a differential Tektronix probe P5200. Efficiency and power factor were measured with a Voltech power meter, model PM300. Temperatures were monitored by thermocouples connected to an Agilent data logger, model 34970A, with supporting BenchLink software.

B. Waveforms

One of the main goals of this work was realizing the highest efficiency possible by enforcing lossless switching in all possible scenarios at all charge levels and repetition rates. The noise immunity of the control circuitry in this sense is also an important issue. A thorough experimental investigation, side by side with PSpice modeling, was performed. We found that, under no circumstances, ZCS was disturbed. Several figures below illustrate the results. Fig. 11(a) shows V_c and primary winding current I_1 in burst operation at a PRR of 1400 Hz for $C_s = 420$ nF (charge rate of 29.4 kJ/s), with the collector current I_c of one of the transistors displayed on expanded scale in Fig. 11(b). The information on horizontal and vertical scales per division here and in further plots is indicated in the waveforms' annotations.

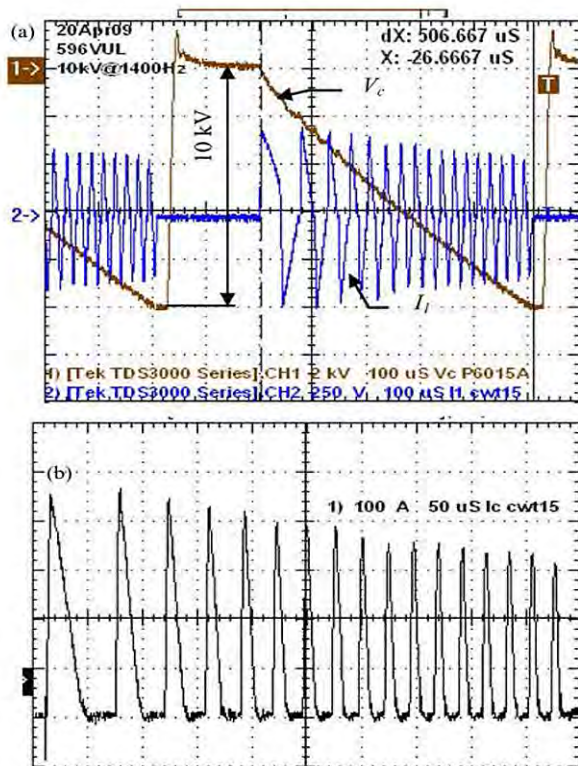
Note that the experimental V_c curves appear to be closer to a linear function than their theoretical counterpart Fig. 4. This discrepancy results from generous deadtime absent in the analytical treatment.

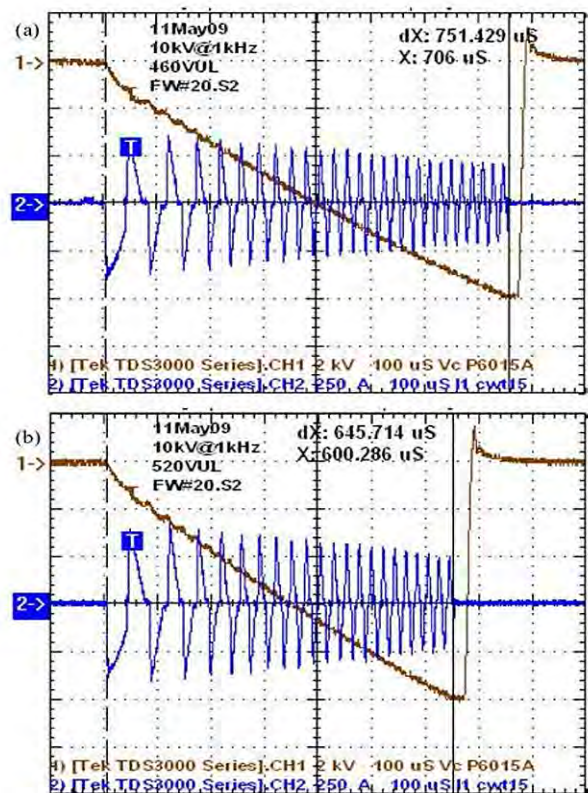

Fig. 12. Typical waveforms at 10 kV at 1000 Hz at (a) low and (b) nominal line.

At low line (longest charge), $C_s = 420$ nF is charged in 750 μ s [Fig. 12(a)], so continuous operation with such load is limited to a PRR of 1 kHz, if ample deadtime is desirable between the shots. At higher line voltage, the charge is accomplished faster [Figs. 11(a) and 12(b)]. As clearly seen in Fig. 11(b), the conversion frequency adapts to keep high duty cycle yet maintaining ZCS. The highest conversion frequency is 55 kHz at low line, with a very large margin guaranteeing ZCS without any shoot-through currents even at abnormal line sags.

C. Efficiency and Power Factor

The efficiency is calculated from the values of the input and load power, the former being measured by a Voltech PM300 power meter. Measuring the load power is indirect. It is actually calculated as the energy per shot delivered to the storage capacitor ($E = C_s \cdot V_c^2/2$) multiplied by PRR. At full power, the efficiency was about 92%, and power factor was 94% (Fig. 13). The efficiency values are lower by 1–2% than expected and what could be deducted from the loss measurement (see [18] for methods of the IGBT loss measurement), and intuitively from the amount of the dissipated heat. We note that the IGBTs' baseplate overheat was less than 40 $^{\circ}$ C at all operational modes. One of the possible sources of error is a low-accuracy V_c measurement (the probe P6015A is specified at $\pm 3\%$ dc attenuation, excluding the oscilloscope error; we minimized this error

TECHNICAL ARTICLES ABOUT HVPS and HV ELECTRONICS

Research Papers

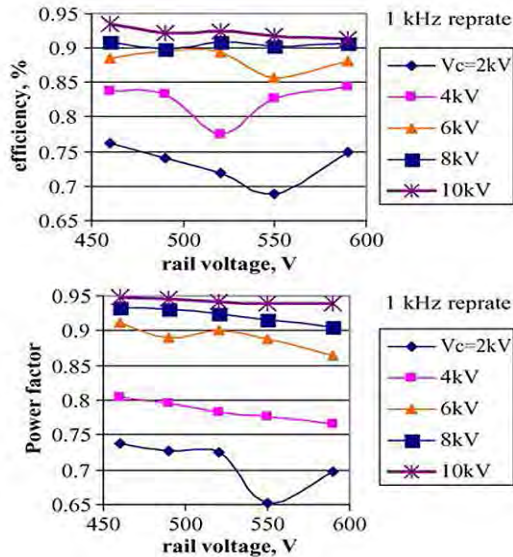

Fig. 13. Efficiency and power factor dependence on rail voltage for several charge voltages.

by careful calibration). Every percent of voltage measurement error is translated to 2% of the energy measurement error, so the uncertainty of the efficiency measurement is quite pronounced.

D. Repeatability

We will distinguish here between short-term and long-term PPR. The former is defined as that derived from N consecutive pulses. In our measurements, $N = 80$, sampled from the 121st to the 200th pulse. Thus, the short-term PPR is not influenced by thermal drifts, aging of components, etc. It is affected by the rail voltage variations to the extent of the high-frequency rail voltage ringing, excluding slow input changes. Long-term PPR is also influenced by the rail voltage variation in the full specified range, for instance, from 460 to 590 VDC (corresponding to $400V AC_{-10\%}^{-14\%}$). In this paper, the reference to long-term PPR is made in the light of such variations, other parameters being not controlled.

PPR measurements were taken using the FastFrame capability of a DPO7054 scope. Up to four signals were monitored simultaneously. The load voltage V_c was measured again by the P6015A probe, but on a 100-mV scale with a 10-V offset allowing the signal at EOC fit the screen. In addition, the feedback voltage V_{fdbk} (with the same sensitivity and offset) and primary current were monitored. The shortcoming of these direct measurements is their low resolution, of the order of several bits of the scope vertical resolution. Arguably, a better technique is differential measurement, e.g., monitoring the difference between the feedback voltage and the programming voltage. In such a way, at EOC, the scope would see virtually zero voltage. In the differential measurement, the feedback voltage was biased with a voltage equal to the programming value. After finding fair matching of the V_c and differential V_{fdbk} data, we continued with direct V_c measurement only.

The scope was triggered by the EOC event. In these experiments, the discharge switch DSw was fired 20 μs after EOC.

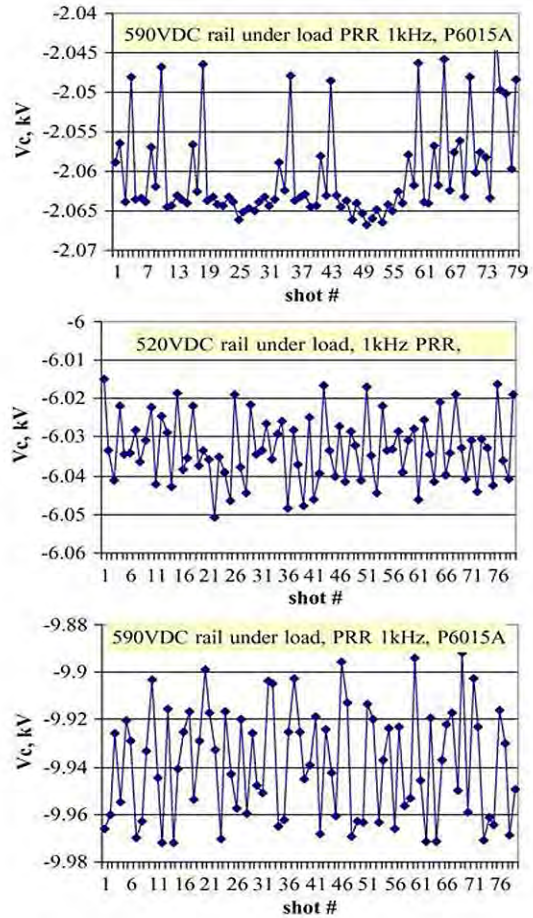

Fig. 14. Shot-to-shot variability taken with FastFrame. $C_s = 420$ nF, 1 kHz replate, 2-kV, 6-kV, and 10-kV settings. See inset annotations for rail voltage.

The first 800 shots were collected with a 500-point resolution on a 4- μs /div scale. The waveforms were saved as screen captures, and 80 frames, starting from the 121st frame, were saved in the csv format. An Excel spreadsheet was designed, in which 79 shots² were processed; they are graphed in Fig. 14 for several rail voltages showing V_c pulse-to-pulse variation.

Three typical screenshots of the overlays of 80 frames are shown in Fig. 15. They correspond to the data of Fig. 14 and show where the variability, at least partially, evolves. At EOC, the primary current is chopped at random. If there is a certain pattern (as seen at 2-kV and 6-kV settings), PPR is better. When the current is chopped at an arbitrary time point (10-kV setting), at the rising and trailing edges and at zero, PPR deteriorates. It still remains below 1% at the maximum voltage and PRR, owing to specifics of the used converter topology and high conversion frequency.

For three rail voltage settings, namely 460, 520, and 590 VDC, PPR was calculated by the formula that looks in an

²Values shown are averages of 50 points, starting from 250 pnt of the acquisition (approximately the middle part of the screen Fig. 15).

TECHNICAL ARTICLES ABOUT HVPS and HV ELECTRONICS

Research Papers

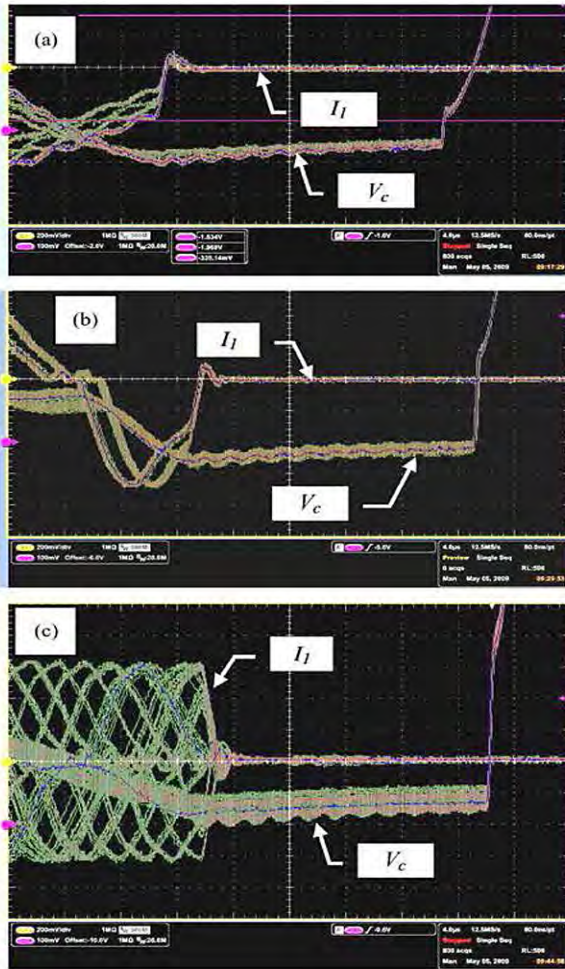

Fig. 15. Overlay of 80 frames (V_c —100 V/div, I_1 —100 A/div) for: (a) high line, 2 kV at 1 kHz; (b) nominal line, 6 kV at 1 kHz; and (c) high line, 10 kV at 1 kHz. Horizontal $4 \mu\text{s}/\text{div}$.

Excel convention as follows:

$$R = \frac{\min(A2 : C80) - \max(A2 : C80)}{\text{average}(A2 : C80)} * 100 \quad (6)$$

where columns A-C contain each V_c values for 79 consecutive pulses, for 460, 520 and 590 VDC, respectively, i.e., $3 \times 79 = 237$ pulses. Alternatively, we varied the line voltage continuously from the low to high level, looking for the least stable operation, i.e., for the largest V_c variation. For this method, PPR was calculated by (1) using $V_{C_{\max}}$, $V_{C_{\min}}$ values from the whole measurement range.

The short- and long-term PPR are plotted in Figs. 16 and 17, respectively. The experimental curves shown in Fig. 17 are calculated by (1), (6); they are labeled as “overall experimental”, and “3 rail experimental”, respectively. Thus, every point of the first curve is built from many thousands shots, and every point of the second one comprises 237 shots. The variability is larger than that predicted by the theory accounting for factor 1 only

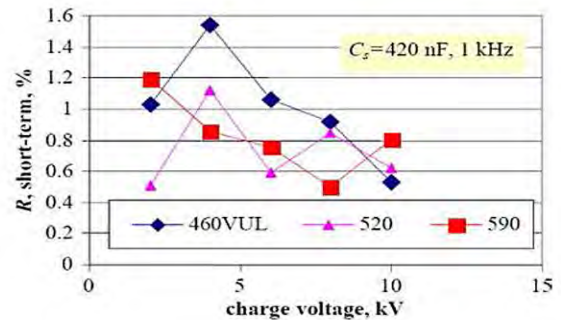

Fig. 16. Short-term repeatability.

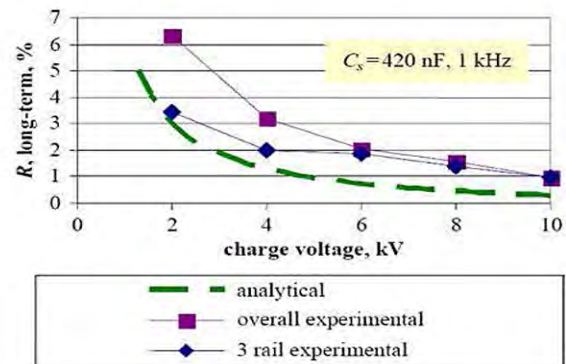

Fig. 17. Long-term repeatability as a function of charge voltage—summary of analytical calculations and experimental results.

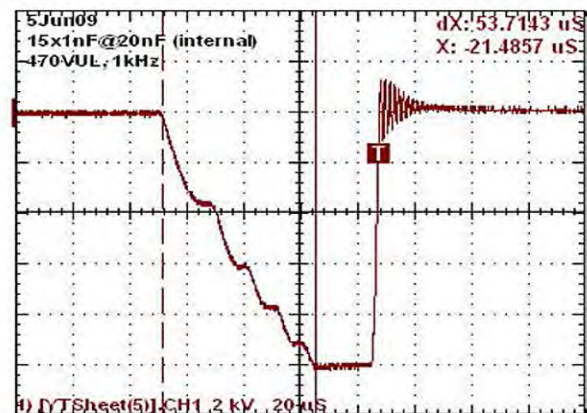

Fig. 18. 33-nF capacitor assembly under test. Charge time is 53 μs .

(“analytical” curve). This discrepancy can be attributed to the measurement errors and propagation delays (factors 2, 3).

All the above results pertain to the experiments with $C_s = 420$ nF. Additional measurements were taken with much smaller $C_s = 33$ nF. A typical charge waveform is shown in Fig. 18. Short charge time allows much higher PRR, up to 7 kHz, leaving ample time between the charge cycles. However, with our SCR-based discharge switch, we cannot operate the system at such high PRR.

Remarkably, although the current chopping at EOC occurs at random (Fig. 19), even with this very low capacitance, PPR

TECHNICAL ARTICLES ABOUT
HVPS and HV ELECTRONICS

Research Papers

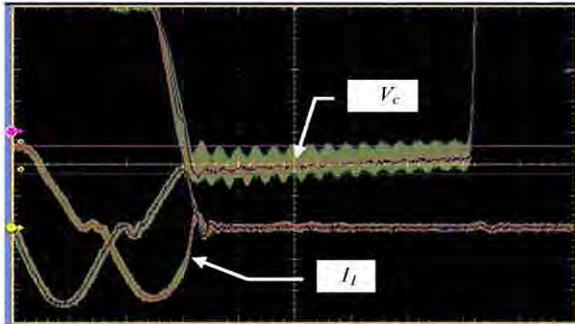

Fig. 19. Overlay of 600 frames (V_c —100 V/div, I_i —200 A/div) $C_s = 33$ nF; 10 kV at 1 kHz, $V_r = 470$ VUL. Horizontal 4 μ s/div.

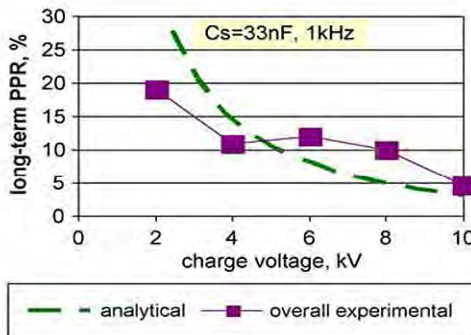

Fig. 20. PPR at low-capacitance charge.

is better than 1% at 10 kV and $V_r = 470$ V. However, with continuous V_r variation, PPR is worse. A summary of the results is shown in Fig. 20. We note that the analytical curve is not valid if the charge occurs during one two half-cycles, which is the case for the 2-kV and 4-kV voltage setting.

At the time of writing this paper, the charger was in continuous operation for 3000 hrs, having generated more than 10^{10} 10-kV shots at 1 kHz, with the test ongoing.

VI. CONCLUSION

This development has been a test case for low-cost generic technology of high repetition rate high-voltage high-power highly efficient capacitor charging. A crossover of 10-kV, 20-kJ/s, and 1-kHz PPR specifications was chosen for the demonstration. An energy-dosing converter topology with smart controls optimizing the switching frequency for high efficiency was used. The switching is accomplished at a frequency of up to 55 kHz employing relatively slow inexpensive IGBTs. High efficiency allowed a compact all-air cooled design. Good PPR was demonstrated.

A rigorous repeatability analysis has been performed, as far as we know, for the first time in open literature. The obtained results allow accurate evaluation of achievable long term PPR for energy-dosing resonant topologies. They also can be extended to the case of classic series resonant converters. Improving the measurements can narrow the gap between the theoretical limit, as put forth by the analytical treatment, and the experimental results, for the long-term repeatability. In addition, the derived

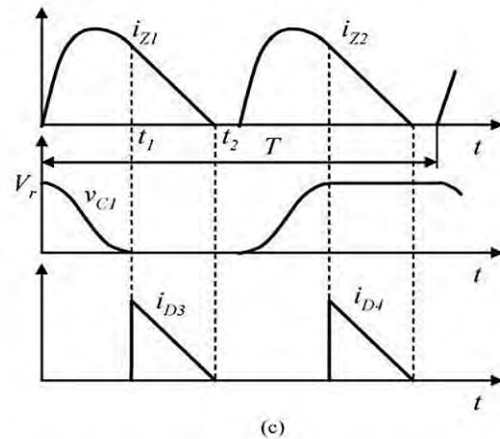
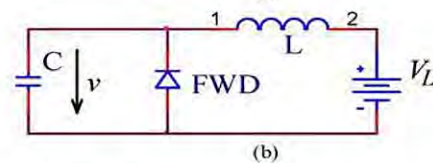
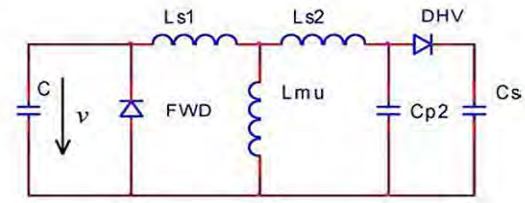

Fig. 21. (a) Full equivalent circuit. (b) Reduced equivalent circuit. (c) Timing diagrams in normal operation (see Fig. 2 for notation).

equations have allowed building a predictive control algorithm, thus paving the road for a dramatic PPR improvement without any slowing of the charge rate. This work will be reported later. Only worst-case analysis is presented in full in this paper.

APPENDIX

The EOC signal is generated when the charge voltage reaches a preset value. This can occur at any time within the transistor conduction interval, and even during the deadtime, since some residual energy E_{rem} still circulates in the system. If the programmed load voltage is calculated as $V_L = \sqrt{2E_c/C_s}$, and the real charge voltage is $V_L + \Delta V_L = \sqrt{2(E_c + E_{rem})/C_s}$, assuming that E_{rem} is delivered to C_s , we transform (1) to a form

$$R = \sqrt{1 + \frac{E_{rem}}{E_c}} - 1. \quad (7)$$

Equation (7) is a simplistic PPR assessment giving largely overstated values (see Introduction).

The last half-period preceding EOC starts as usual, with one of the resonant capacitors charged to the rail voltage, and the other fully discharged. We neglect here the rail/busbar voltage oscillations and the FWD forward drop. A full-scale EC is shown in Fig. 21(a). Here, $C = 2C1 = 2C2$, diode

TECHNICAL ARTICLES ABOUT
HVPS and HV ELECTRONICS
Research Papers

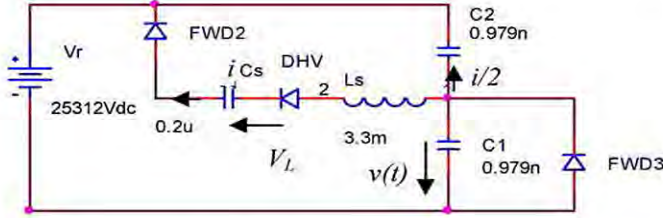

Fig. 22. Equivalent circuit after EOC. FWD2 is parallel to transistor, DHV stands for HV rectifier. All parameters are reflected to secondary. Ls current is split equally between Vr and C2 if FWD3 does not conduct.

DHV denotes the HV rectifier. A T -equivalent circuit of the transformer is used, where Ls1, Ls2 are the leakage inductances of the primary and the secondary windings, respectively, Lmu is the magnetizing inductance, Cp2 is the transformer parasitic capacitance. All parameters and variables are reflected to the secondary.

Full circuit is too complicated for analytical treatment. In our case of the transformer with a closed magnetic system, the magnetizing current can be neglected. Likewise, in high-power applications, the parasitic capacitances of the HV transformer and rectifier can be neglected. We assume also that the load voltage $V_L \equiv V_C$ does not change much during a half-period of the conversion frequency; hence, the storage capacitor can be represented by a counter electromotive force equal to the load voltage. This common assumption works well if the charge is accomplished in two or more periods of the conversion frequency. Then, the circuit Fig. 21(a) reduces to that of Fig. 21(b), and the correspondent equations and timing diagrams can be borrowed from [15]. Here, L is the transformer leakage inductance.

The inductance L current and the resonant capacitance C voltage before t_1 are given as (a misprint made in [15] is corrected)

$$i_1 = \frac{V_r - V_L}{\rho} \sin \omega t, \quad v_1 = (V_r - V_L) \cos \omega t + V_L \quad (8)$$

where $\omega = 1/\sqrt{LC}$, $\rho = \sqrt{L/C}$.

After EOC has been generated at time t_c , the EC transforms to that of Fig. 22. The values are for reference only. This EC is valid until the clamping FWD starts conducting. With the current and voltage directions as indicated by the arrows, the circuit is described by the differential equation

$$\frac{d^2 v}{dt^2} + \omega^2 v = \omega^2 (V_L + V_r). \quad (9)$$

Equation (8) provides IC for the analysis

$$i_1(t_c) = \frac{V_r - V_L}{\rho} \sin(\omega t_c)$$

$$v_1(t_c) = (V_r - V_L) \cos(\omega t_c) + V_L \quad (10)$$

or, restarting from zero the time count for the EC Fig. 22

$$i_1(0) = \frac{V_r - V_L}{\rho} \sin(\omega t_c), \quad \frac{dv_1}{dt}(0) = -\frac{i(0)}{C}. \quad (11)$$

Equation (9) with IC (10) has a solution

$$v = (V_L - V_r) \sin \omega t_c \cdot \sin \omega t + [(V_r - V_L) \cos \omega t_c - V_r] \cos \omega t + V_r + V_L \quad (12)$$

wherefrom the inductor current is

$$i = \frac{1}{\rho} [(V_r - V_L) \sin \omega(t + t_c) - V_r \sin \omega t]. \quad (13)$$

It crosses zero at a time point T_{ei}

$$T_{ei} = \frac{1}{\omega} \arctg \frac{(V_L - V_r) \sin \omega t_c}{(V_r - V_L) \cos \omega t_c - V_r}. \quad (14)$$

Depending upon the EOC time C_s and the load voltage, the latter increases after EOC by

$$\Delta V_L = \frac{1}{C_s} \int_0^{T_{ei}} i dt. \quad (15)$$

There is some inconsistency in this analysis, because the clamping action of the FWD is not accounted for. A more correct approach would be to check if and where voltage v reaches zero, integrate to the time of the voltage crossing zero, and continue the analysis from this point using a simpler equivalent circuit that is a subset of Fig. 22, with C1, C2 out of action. However, we simplify the analysis at this point, assuming that in the worst-case scenarios, C does not discharge fully. This assumption is borne by formal analysis, simulations and experiment.

After some derivations, we obtain the output overshoot

$$\Delta V = \frac{C}{C_s} \{ (V_r - V_L) [\cos \omega t_c - \cos(\omega T_{ei} + \omega t_c)] - V_r (1 - \cos \omega T_{ei}) \} \quad (16)$$

and the repeatability R % as defined by (1), ($V_{Cavg} = V_L$, in a closed form

$$R = \frac{100}{V_L} \frac{C}{C_s} \{ (V_r - V_L) [\cos \omega t_c - \cos(\omega T_{ei} + \omega t_c)] - V_r (1 - \cos \omega T_{ei}) \}. \quad (17)$$

Equations (12)–(17) are valid if v does not reach zero before i does.

Introducing a nondimensional variable $v_i = V_L/V_r$, we rewrite (17) as

$$R = 100 \frac{C}{C_s} \{ (1/v_i - 1) [\cos \omega t_c - \cos(\omega T_{ei} + \omega t_c)] - 1/v_i (1 - \cos \omega T_{ei}) \} \quad (18)$$

which is plotted in Fig. 23; (16) is plotted in Fig. 24 for $V_r = 550$ V. In these calculations, $C1 = C2 = 2 \mu\text{F}$ ($C = 1.958$ nF), $C_s = 200$ nF. It is seen that the maximum error occurs at a t_c that is slightly smaller than a quarter of the period of the resonant frequency $T = \omega/2\pi$.

TECHNICAL ARTICLES ABOUT HVPS and HV ELECTRONICS

Research Papers

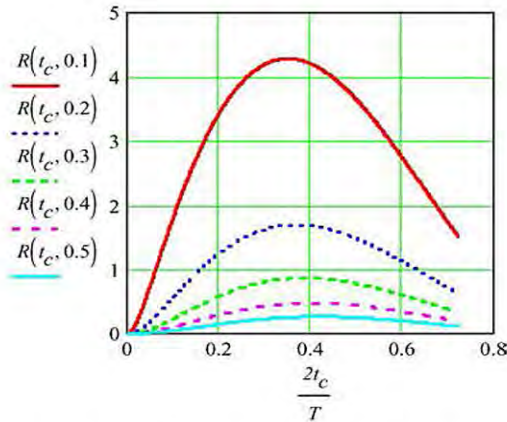

Fig. 23. Repeatability R % versus chopping point t_c , with normalized load voltage v_l as a parameter. $T = 2\pi/\omega$.

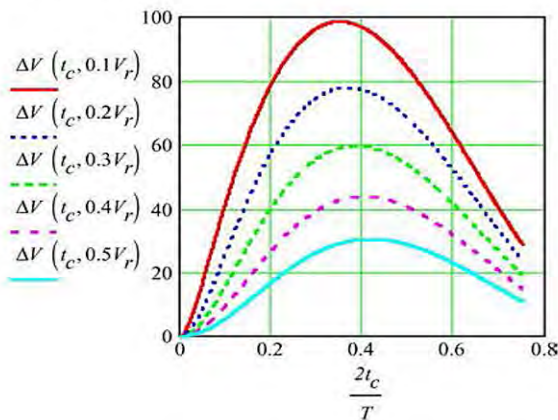

Fig. 24. Load voltage overshoot dependence on EOC timing t_c for $V_r = 850$ V. Load voltage in fractions of V_r serves as parameter.

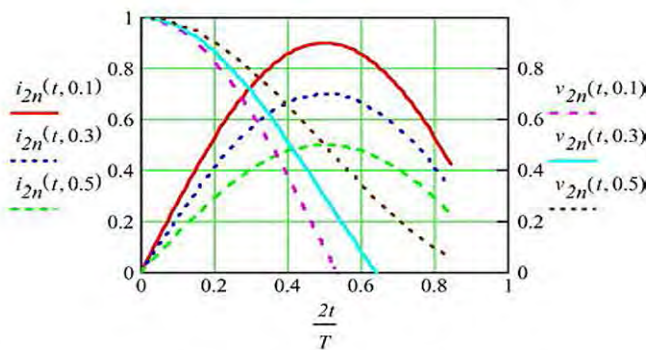

Fig. 25. Normalized inductor current and resonant cap voltage. v_l serves as a parameter.

Looking again at (8) and rewriting them in a normalized form

$$i_{2n} = (1 - v_l)\sin \omega t, \quad v_{2n} = (1 - v_l)\cos \omega t + v_l \quad (19)$$

where $i_{2n} = i_2/I_0$, $I_0 = V_r/\rho$, $v_{2n} = v_2/V_r$, we note that the resonant capacitors do not discharge to zero before $t_c \sim 0.5T$, which is shown in Fig. 25.

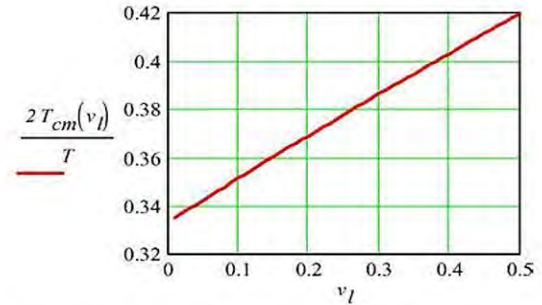

Fig. 26. Worst chopping moment versus normalized load voltage.

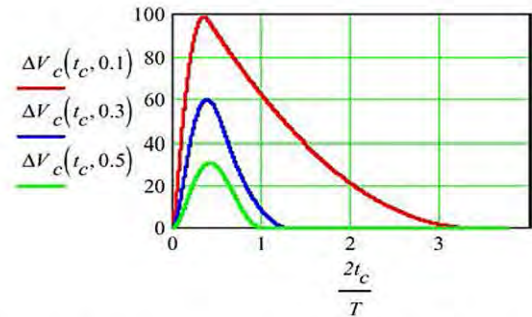

Fig. 27. Load voltage increment dependence on EOC timing t_c for $V_r = 850$ V. Compare to Fig. 24.

Alternatively, we can solve

$$\frac{dR(t_c, V_l)}{dt_c} = 0 \quad (20)$$

for t_c , thus finding at what t_c R reaches maximum. This time point is designated as T_{cm} . The expressions are too bulky to reproduce here, but the solution plotted in Fig. 26, in conformity with Fig. 25, clearly indicates that the worst PPR corresponds to the EOC time point, at which the resonant capacitors do not discharge fully. A rigorous analysis involving sequential ECs is even more complex; we give an example chart Fig. 27 corroborating the validity of the aforementioned statements. Thus, the worst-case analysis is complete.

ACKNOWLEDGMENT

The authors would like to thank A. Lipovich for his help in mechanical design.

REFERENCES

- [1] H. Bluhm, *Pulsed Power Systems: Principles and Applications*. Berlin, Germany: Springer-Verlag, 2006.
- [2] [Online]. Available: <http://www.gaep.com/product-applications.html>
- [3] J. Jichetti, A. Bushnell, and R. McDowell, "Precision capacitor charging switching power supplies," in *Proc. 14th IEEE Pulsed Power Conf.*, Jun. 2003, pp. 522–525.
- [4] G. L. Bees and A. Tydeman, "Capacitor charging power supply design for high pulse to pulse repeatability applications," in *Proc. 12th IEEE Pulsed Power Conf.*, Jun. 1999, pp. 397–398.
- [5] J. Biebach, P. Ehrhart, A. Müller, G. Reiner, and W. Weck, "Compact modular power supplies for superconducting inductive storage and for capacitor charging," *IEEE Trans. Magn.*, vol. 37, no. 1, pp. 353–356, Jan. 2001.

TECHNICAL ARTICLES ABOUT HVPS and HV ELECTRONICS

Research Papers

- [6] M. M. McQuage, V. P. McDowell, F. E. Peterkin, and J. A. Pasour, "High power density capacitor charging power supply development for repetitive pulsed power," in *Proc. PM*, 2006, pp. 368–371.
- [7] A. K. Jaint, C. P. Henze, C. B. Henze, and K. Conroy, "Development of a 350 kW, 10 kV pulse power converter for capacitor charging," in *Proc. 22nd APEC*, Feb. 25–Mar. 1, 2007, pp. 1164–1170.
- [8] J. S. Oh, S. D. Jang, Y. G. Son, M. H. Cho, and W. Namkung, "Development and application of an inverter charging supply to a pulse modulator," in *Proc. LINAC*, Gyeongju, Korea, 2002, pp. 205–207.
- [9] H. J. Ryoo, S. R. Jang, J. S. Kim, and Y. B. Kim, "Design and testing of the high voltage capacitor charger for 150 kJ pulsed power application," in *Proc. 17th Int. Pulsed Power Conf.*, Washington, DC, Jun. 28–Jul. 2, 2009.
- [10] *Regulation and Repeatability*, APP Note 509, A.L.E. Systems. [Online]. Available: http://www.us.tdk-lambda.com/hp/product_html/high_volt.htm
- [11] *High Power, High Voltage Power Supply Voltage Regulation*. [Online]. Available: <http://www.gaep.com/voltage-regulation.html>
- [12] R. Ness, P. Melcher, G. Ferguson, and C. Huang, "A decade of solid state pulsed power development at Cymer Inc.," in *Proc. 26th Power Modulator Symp.*, May 23–26, 2004, pp. 228–233.
- [13] A. Pokryvailo, C. Carp, and C. Scapellati, "High power, high efficiency, low cost capacitor charger concept and demonstration," in *Proc. 17th IEEE Int. Pulsed Power Conf.*, 2009, pp. 801–806.
- [14] B. D. Bedford and R. G. Hoft, *Principles of Inverter Circuits*. New York: Wiley, 1964.
- [15] B. Kurchik, A. Pokryvailo, and A. Schwarz, "HV converter for capacitor charging," in *Pribory i Tekhnika Experimenta*. New York: Plenum, 1990, pp. 121–124.
- [16] M. Wolf and A. Pokryvailo, "High voltage resonant modular capacitor charger systems with energy dosage," in *Proc. 15th IEEE Int. Conf. Pulsed Power*, Monterey, CA, Jun. 13–17, 2005, pp. 1029–1032.
- [17] [Online]. Available: <http://www.spellmanhv.com/Products/Rack-Supplies/SR.aspx>
- [18] A. Pokryvailo and C. Carp, "Accurate measurement of on-state losses of power semiconductors," in *Proc. 28th Int. Power Modulators Symp.*, Las Vegas, NV, May 27–31, 2008, pp. 374–377.



Alex Pokryvailo (M'05–SM'07) was born in Vyborg, Russia. He received the M.Sc. and Ph.D. degrees in electrical engineering from the Leningrad Polytechnic Institute, St. Petersburg, Russia, in 1975 and 1987, respectively.

Formerly with Soreq NRC, Yavne, Israel, he is now with Spellman High Voltage Electronics Corporation, Hauppauge, NY. His current and recent experience relates to pulsed power, with emphasis on high-current opening and closing switches and magnetic design, fast diagnostics, design of HV high-power switch-mode power supplies, and corona discharges. Previously, he studied switching arcs, designed SF₆-insulated switchgear, made research in the area of interaction of flames with electromagnetic fields, etc. He has published over 100 papers, two textbooks (in Hebrew), and is the holder of more than 20 patents pertaining to HV technology.

Costel Carp (M'07), photograph and biography not available at the time of publication.

Clifford Scapellati (M'92), photograph and biography not available at the time of publication.

Comparative Testing of Simple Terminations of High-Voltage Cables

Key words: high-voltage cable, direct current, polyethylene insulation, shrink tubes, stress grading tapes, corona, space charge

Introduction

In HV systems, cable terminations are one of the weakest links. The majority of failures occur on the ground shield side. This side is especially stressed by the electric field in free space connections. Field control and rigorous technological processes are key to reliable functioning. The first was realized for a century by stress relief cones in conjunction with solid dielectric fillings. Later, stress-grading nonlinear materials in the form of paint, tapes, and tubes were used with much success (see, e.g., [1]–[3] and their bibliography). In dc applications, which are the main interest of this paper, the falling resistivity-field characteristic effectively pushes the electric field off the shield terminus, where it is strongest.

Many field calculations for cable terminations have been published, analytical and numerical, using both linear and nonlinear approaches [1]–[6]. Understandably, they did not address the space charge formation arising from ionization around sharp edges. In fact, most designs avoid fields strong enough to cause ionization. It also seems that little or no work has been done on leakage current (LC) flowing along the cable termination. In low-current, precision HV applications, these currents may be comparable with the load current, and being inherently unstable, can compromise stability. At the same time, low-cost design limits the use of high-quality materials and/or elaborate field control techniques. These limitations are especially important in open-space connections characterized by very unfavorable stress concentration at the shield terminus.

In this light, several termination types for polyethylene HV cables were tested for dielectric strength and LC, down to the picoampere level. It was not the goal of this work to investigate partial discharge (PD) phenomena, in the cable body or in its terminations, although we are fully aware of possible correlation between PD and LC.

Experimental Setup

This section describes the layout of the test setup, the design of the tested cables, and the experimental routines.

**Alex Pokryvailo, Costel Carp,
and Clifford Scapellati**

*Spellman High Voltage Electronics Corporation
475 Wireless Boulevard
Hauppauge, NY 11788*

In high-voltage cable terminations, leakage currents often originate from the ground shield. Design factors significantly influence their magnitude and temporal behavior.

Test Rig

The test bench (Figure 1) comprises a test power supply unit (PSU) V1 with its HV cable T1, cable under test (CUT) T2, and measurement and data-acquisition equipment. Two PSUs (Spellman SL130kV and XRF180kV series) provide smooth voltage regulation and high stability in the range 0–130 kV and 0–180 kV for positive and negative polarities, respectively. The HV leads of the CUT and the PSU cable are connected together, whereas the CUT shield is grounded through a current-measuring device (Keithley picoammeter 6487). A typical physical implementation is shown in Figure 2.

High-voltage leads of all cables were connected physically to the HV electrode of a voltage divider (Spellman model HVD-100) [7] capable of corona suppression up to 130 kV, as suggested by electric field analysis. In this way, the LCs generated by the ionization (corona) mechanism at the CUT *shield side only* are collected and directed through the picoammeter. To exclude the current originating at the lead end of the CUT, we screened its shield by a grounded copper electrode.

TECHNICAL ARTICLES ABOUT
HVPS and HV ELECTRONICS
Research Papers

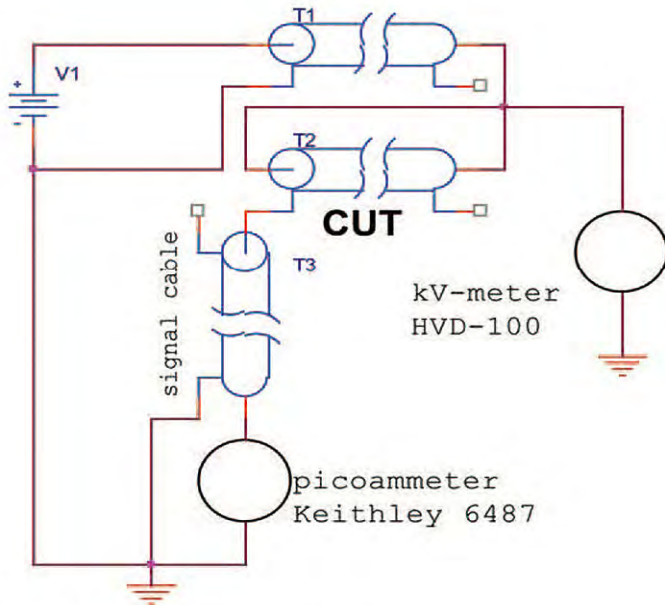

Figure 1. Schematic layout of test rig.

CUT designation	Termination method	Termination length <i>l</i> (Figure 3d, f), cm
(CUT#1)	FC, no SHT	20
(CUT#2)	FC, SHT	20
(CUT#3)	FC, SHT	14.7
(CUT#4)	O-ring cross-section diameter 2 mm, SHT	14.7
CUT#5	Shield flapped over protective jacket, tape 217.21	14.7 cm, 3 cm from shield covered by 217.21
CUT#6	Shield flapped over, HiK 6501	14.7 cm, 3 cm from shield covered by tape HiK 6501

CUTs

Several CUTs were manufactured from a 2124 Dielectric Sciences Polyethylene (PE) cable. All of them were approximately 2.5 m long. Their main parameters are summarized in Table 1, and photos of several of them are shown in Figure 3. The acronyms FC and SHT stand for flush cut and shrink tube, respectively (Alpha Wire Company irradiated polyolefin SHTs were used). Semiconductive stress-grading tape VonRoll 217.21 is SiC based and exhibits nonlinear behavior. Its conductivity increases at higher fields, effectively suppressing corona. HiK 6501 tape from Dielectric Sciences is defined as conductive. However, its resistivity was too large to be measured at low voltage using digital voltmeters. Its datasheet is unavailable.

Test Procedure

For LC, every cable was tested in steps of, typically, 10 kV up to 90 kV and steps of 5 kV above 90 kV. CUT#6 was not tested

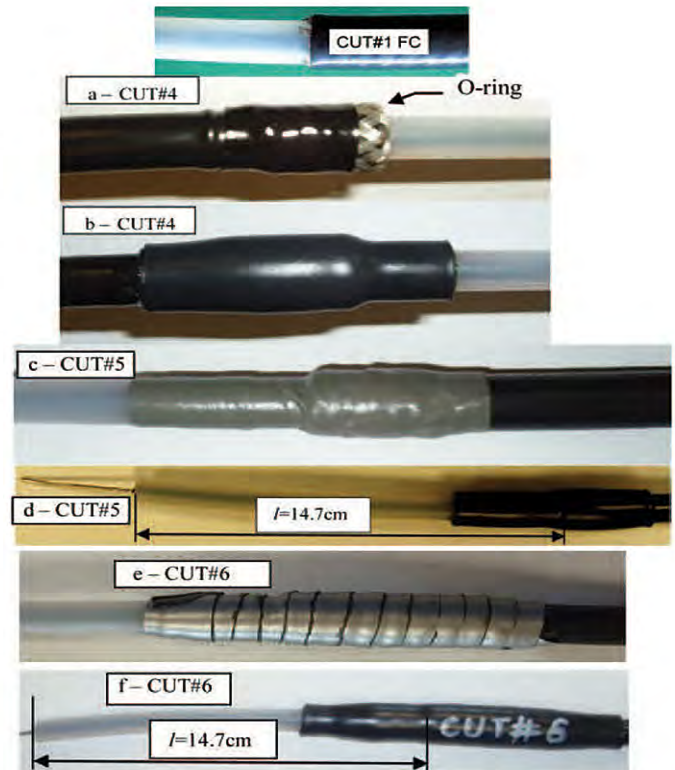

Figure 3. CUT#1 showing loose strands. a) CUT#4, shield flapped over protective jacket and held by shrink tube (SHT); b) CUT#4, additional SHT cover; c) CUT#5, shield flapped over jacket and held by semiconductive tape Von Roll 217.21 protruding ~3 cm onto bare polyethylene (PE); d) CUT#5 ready for test, SHT cover on top of semiconductive tape; e) CUT#5, shield flapped over and held by HiK 6501 protruding ~3 cm onto bare PE; f) CUT#6 ready for test, SHT cover on top of HiK tape.

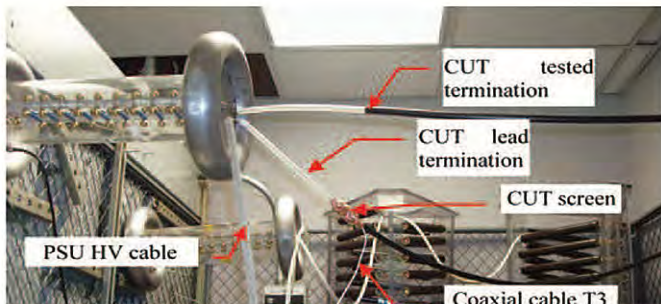

Figure 2. Experimental setup.

TECHNICAL ARTICLES ABOUT HVPS and HV ELECTRONICS

Research Papers

at negative polarity. It is important to note that the voltage was changed monotonously, always increasing. Every test voltage was applied a minute before collecting the LC data transferred from the Keithley picoammeter to a PC using Keithley ExceLINX software. Thirty-five values were collected and stored at each measurement, which lasted 46 s, and averaged. Volt-ampere characteristics were constructed from the averages.

Ambient temperature and humidity were typically 25°C and 60 %, respectively. They were not monitored, but it is unlikely that they varied significantly during data collection.

CUTs#3, 4, 5, and 6 were subjected to breakdown voltage tests. The voltage was raised at a rate of approximately 2 kV/s to breakdown and then reduced to a level at least 20 kV lower than the registered breakdown voltage. The test was repeated 2 to 4 times. In view of the damage sustained by the shrink insulation and semiconductive tape, these were replaced before testing with the opposite polarity. Given the small number of samples, no averaging or other statistical processing was applied to the disruptive test data. The flashover was videotaped to document the flashover pattern.

Experimental Results

Leakage Current Measurement

To establish a baseline, the first measurements were conducted on the FC bare cable CUT#1. The LC was stable in time, especially at positive polarity voltages (grounded shield negative) higher than 20 kV, as shown in Figure 4a. The LC reached 40 μA at +90 kV and 98 μA at -90 kV (Figure 4b). To ensure that the current did indeed originate at the cable shield, an additional experiment was conducted in which the FC was protected by a relatively low-curvature electrode. This reduced the current to less than 3 μA at +90 kV. Obviously, the current was generated by a corona discharge.

Covering the shield termination by SHT suppressed the leakage by orders of magnitude (Figure 5), especially at positive polarity, which also confirms the origin of the leakage current as the shield cut of the tested termination end. Reducing the length of the bare PE to $l = 14.7$ cm in CUT#3 resulted in somewhat higher leakage. The height of the error bars in these and similar plots is the standard deviation calculated over all 35 measurements. Using an O-ring termination (CUT#4) with SHT, of the same length as the bared PE, caused the LC to drop by an order of magnitude, compared with the FC of CUT#3 (Figure 6), at both polarities (compare with Figure 5).

CUT#5 with semiconductive tape and CUT#6 with HiK tape (Figure 7) had the lowest LCs, of order 1 nA at 100 kV at positive polarity. Also, the currents increased fairly smoothly with increasing voltages, i.e., there were very few picoammeter overflows on the 200-nA range, whereas other cables could be tested only on the 20- μA range at 100 kV. CUT#5 was also tested at negative polarity. The LC was large (Figure 8), even higher than that of CUT#4 (Figure 6).

The negative-polarity LCs were always higher than those at positive polarity. The reasons for this are discussed in the Analysis and Discussion section.

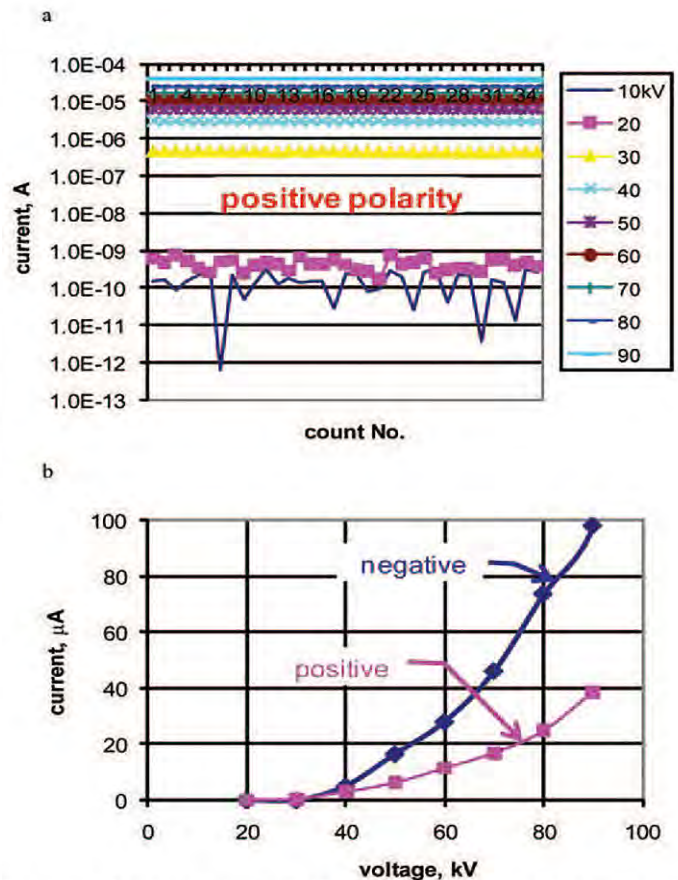

Figure 4. Leakage current (LC) for CUT#1 (flush cut, no shrink tube). a) LC dependence on time (count number) at positive polarity; b) LC as a function of applied voltage at positive and negative polarity.

Breakdown Voltage Tests

The tests were conducted as indicated in the Test Procedure section.

At positive polarity, for CUT#3, the first flashover occurred at 104 kV along the surface of the test termination. The subsequent breakdowns (at 124 kV) occurred along the surface of the much longer lead termination. The path change may be attributed to conditioning of the shield, i.e., removal of loose strands by the arc.

CUT#4 had a different flashover pattern, with the spark bridging the shield and the HV electrode of the HVD-100 voltage divider through the air (Figure 9). First breakdown was at 124.5 kV, and subsequent ones were at 112, 113, and 117 kV. CUT#5 and CUT#6 behaved very similarly to each other but very differently from the other specimens. They broke down at 130 kV after ~10 s exposure. The first flashover reached the folded end of the shield, as indicated by the arrow in Figure 10. Consecutive breakdowns occurred at the same voltage, but the luminous channel ended at the shrink sleeve end.

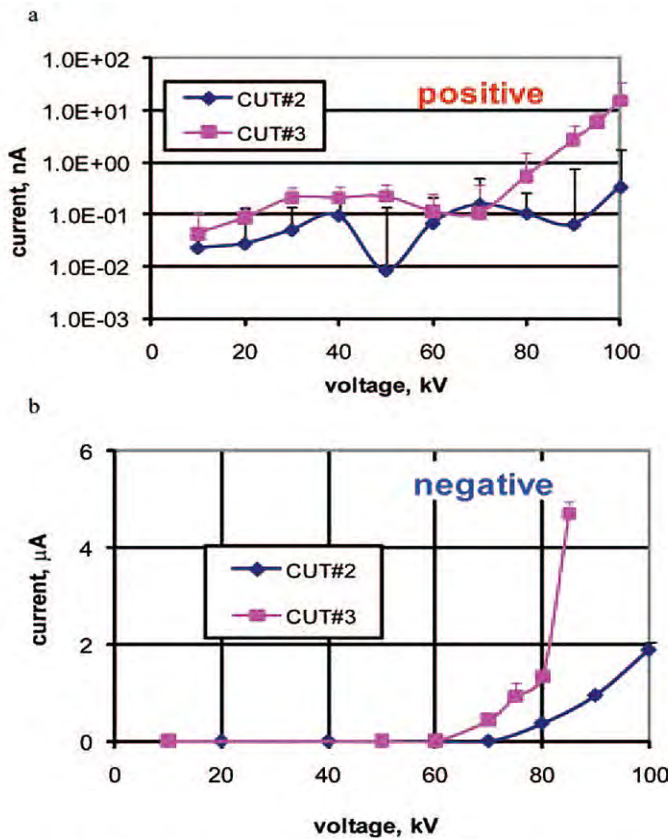

Figure 5. Leakage current as a function of applied voltage for CUT#2 [flush cut (FC), shrink tube (SHT), $l = 20$ cm polyethylene bared length] and CUT#3 (FC, SHT, $l = 14.7$ cm) at (a) positive and (b) negative polarity.

At negative polarity, CUT#4 flashed over the PE surface, with the spark anchored at the O-ring. The first breakdown was at 126 kV, and subsequently at 109 and 104 kV, almost identical to the positive-polarity case. CUT#5 broke down at 136 kV after ~5 s exposure. The first flashover reached the folded end of the shield, as indicated by the arrow in Figure 11. The second breakdown occurred at the same voltage, but intense corona started forming at 80 kV. The other cables were not tested at negative polarity.

Analysis and Discussion

The cable-insulating system comprising PE, SHT, and air is difficult to analyze because of its ill-defined geometry and the nonlinear electrical characteristics of some of the materials. Thus, accurate electric field calculations are difficult, if not impossible. However, several general features can be observed.

In dc systems, conduction currents govern the field distribution, but displacement currents are more important during fast transient processes and under ac conditions (50 Hz and higher). In other words, the material conductivity is dominant at dc, but the material permittivity is dominant at ac. This is now well recognized [8]-[11].

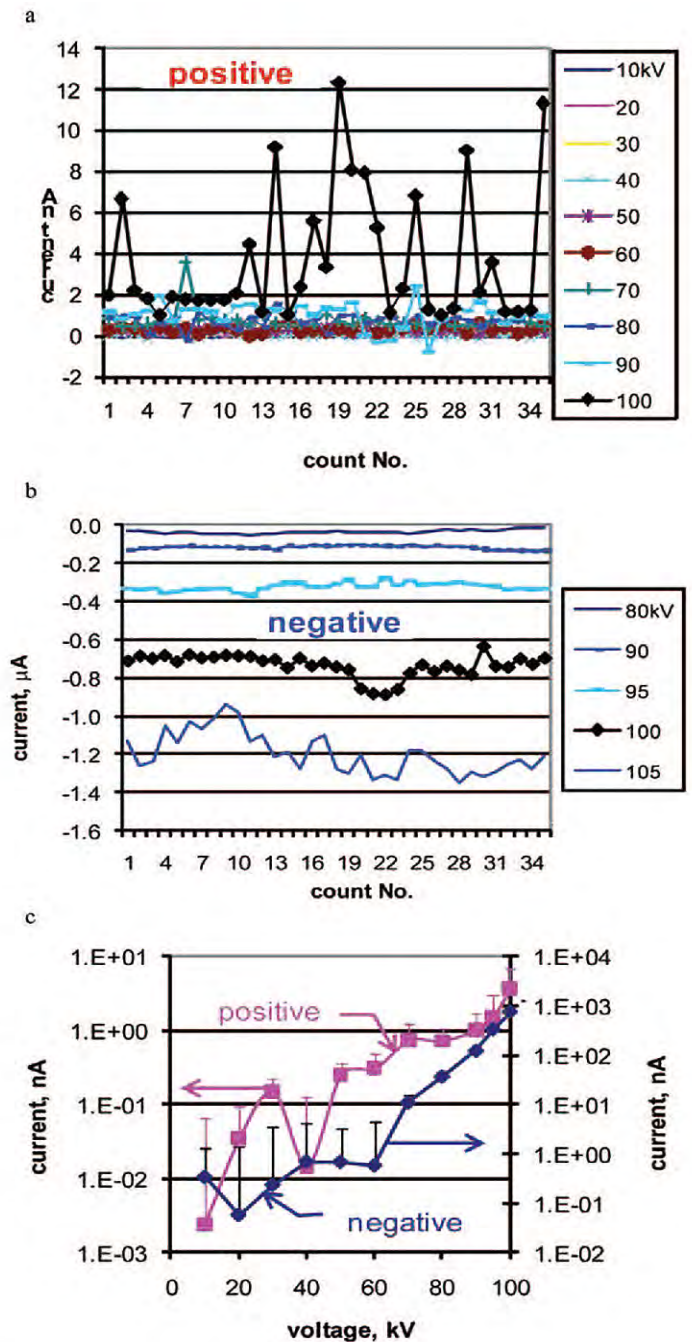

Figure 6. Leakage current (LC) of CUT#4 (O-ring, shrink tube). a) LC dependence on time (count number) at positive polarity; b) same at negative polarity; c) LC as a function of applied voltage at positive and negative polarity.

The differences in the field distribution can be seen in Figures 12, 13, and 14, which were generated using Ansoft Maxwell 2D Student Version [12]. The assumed geometry approximates that

TECHNICAL ARTICLES ABOUT HVPS and HV ELECTRONICS

Research Papers

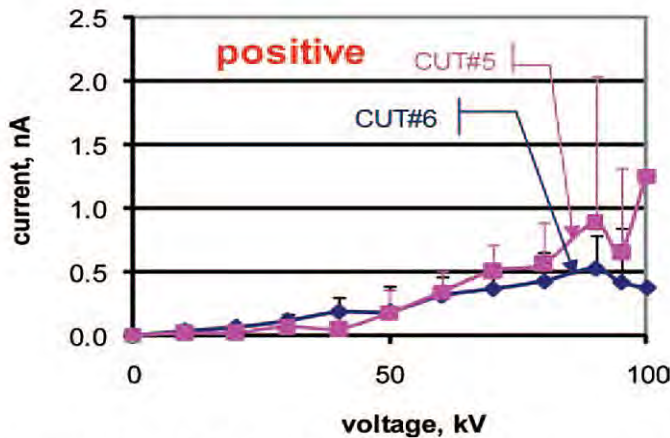

Figure 7. CUT#5, CUT#6. Leakage current at positive polarity.

of the test arrangement (see Figure 2). In all calculations, the potential difference between the HV electrodes and ground was 1 V. Because we are dealing with a linear problem, the results can be scaled with the applied voltage. Plots a and b correspond to the dc and ac cases, respectively. In the former, the ratio of PE resistivity to that of air was taken as 100, and in the latter, the relative permittivity of PE was set at 2.25. The field under ac is much less uniform. The dc distribution is greatly influenced by the temperature dependence of the component conductivities. Irrespective of the applied voltage waveform, the field may be further modified by ionization processes and reduced or enhanced by space and surface charges. At negative polarity on the sharp electrode, space charge tends to reduce the maximum field. Semiconductive tapes have the same effect under *both* polarities, suppressing ionization and improving LC stability.

Obviously, the high fields predicted by the field analysis for FC without SHT ($E > 100$ kV/cm for both cases at a voltage greater than 60 kV) would lead to air ionization. This is manifested by CUT#1 with exposed shield and short (~1 mm) loose strands protruding outward from it randomly, which lead to further field enhancement. Clearly, large currents drawn from the shield (Figure 4) are generated by a mechanism similar to corona, which may also be described as creeping discharge. Currents became measurable at voltages above 30 kV for both polarities. Scaling Figure 13a up to 30 kV suggests a field of 50 kV/cm at this voltage, which surprisingly agrees with the values for the corona onset fields, in similar air gaps, given on page 153 of [13]. In agreement with published data [13], [14], *at the same applied voltage*, the corona current is greater for positive polarity of the sharp electrode (shield) or, in the terminology of this article, at negative polarity. It should be further emphasized that although positive corona draws larger current than its negative counterpart, the difference in a unipolar corona mode is small, in the range of 20–30%. The reason is that the mobilities of positive and negative ions are very similar in electronegative gases. Positive streamer corona developing at higher voltages in large gaps tends to draw much larger current but transits to spark at lower voltage than negative corona [15]. This effect is related to the streamer mechanism of discharge described in [14] and [16].

If the SHT resistivity is lower than that of PE, the field at the shield edge is weakened considerably (Figure 14), below the corona onset level. This might partially explain the dramatic improvement brought about by the SHT covering. Here we adopted the figures of $10^{14} \Omega\cdot\text{m}$ [17], $10^{12} \Omega\cdot\text{m}$ [18], and $10^{13} \Omega\cdot\text{m}$ for the resistivities of PE, SHT, and air, respectively. Beyer *et al.* [19] cited a resistivity of $4 \cdot 10^{14} \Omega\cdot\text{m}$ for air at STP, but we have used $10^{13} \Omega\cdot\text{m}$ in view of the fact that the gas resistivity is higher in the absence of ionization. Note that the term *resistivity* must be applied cautiously because the current conduction is limited by saturation in a wide field strength range below the onset of impact ionization [14], [20], [21]. Shrink tube weakens the field because of its permittivity and conductivity values but generates only minor ionization in residual air pockets. The charges generated in this way are trapped and neutralize the external field, thus suppressing the ionization and greatly reducing the LC (Figure 5 and Figure 6). The sometimes erratic behavior of the LC curves is probably due to accumulation and decay of these charges, these processes frequently having large time constants because of the high resistivity of the dielectrics.

The O-ring termination reduces the external field and is superior to FC in that it is free of loose copper strands. The O-ring termination was effective at both polarities.

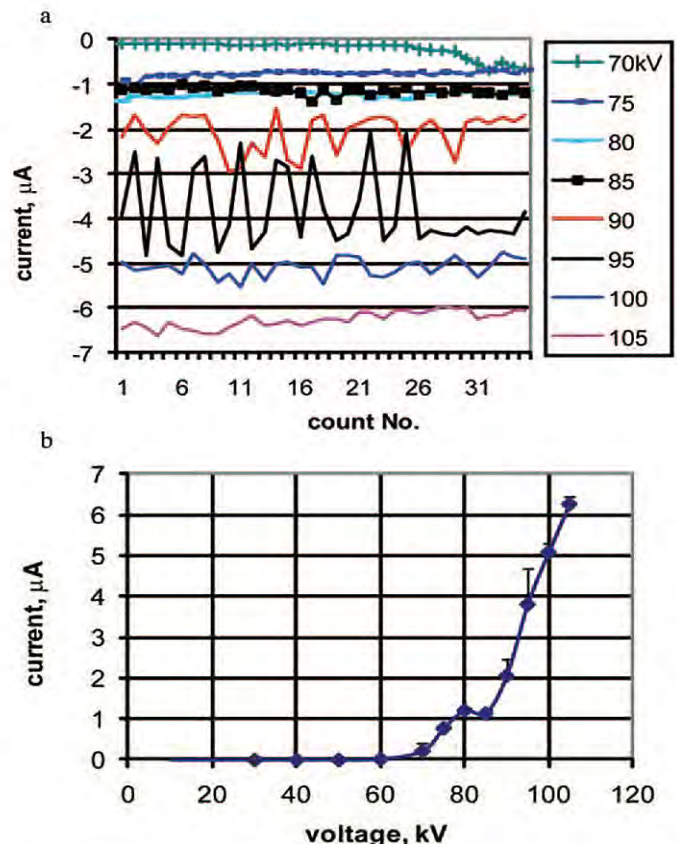

Figure 8. CUT#5. Leakage current (LC) at negative polarity. a) LC dependence on time (count number); b) LC as a function of applied voltage.



Figure 9. CUT#4. Photo of flashover. Positive polarity.



Figure 10. CUT#5. Photo of flashover. Positive polarity.

At negative polarity, the O-ring termination had lower LCs than the other CUTs. However, the breakdown voltage of CUT#5 was slightly higher than that of the O-ring termination. Because only 2 samples were tested, quantitative comparison is not useful. However, the flashover patterns for these designs are informative. For both polarities, the flashover followed the short path to the shield with FC and O-ring terminations but chose the long path in the case of the semiconductive and HiK tapes. Thus, the field at the shield termination is weakened by the tape, and so the breakdown voltage is higher.

Stress-grading tapes have the effect of pushing the field away from the shield. At positive polarity, CUT#5 and CUT#6 had very stable and low LCs. Their breakdown voltages were considerably higher than those of the other designs.

In our opinion, stress-grading tapes are not necessary for most dc applications but offer a major advantage for ac and pulsed applications.

For the cables equipped with SHTs, the LC at positive polarity was 3 orders of magnitude lower than that at negative polarity. We do not have a convincing explanation for this effect. N



Figure 11. CUT#6. Photo of flashover. Positive polarity.

TECHNICAL ARTICLES ABOUT
 HVPS and HV ELECTRONICS
 Research Papers

Figure 12. Field plots (equipotential lines). a) dc field; b) ac field. Potential difference is 1 V.

merous publications deal with the influence of dielectric barriers on the breakdown voltage of gas gaps, particularly in relation to polarity, barrier placement, identity of the gas, and its temperature and pressure [13], [14], [16], [19]-[23]. However, they do not discuss LCs.

Consider the influence of space charge on the discharge mechanism in gas gaps with strongly nonuniform electric fields. At negative polarity (positive shield), negative space charge attracted to the shield enhances the field, thus promoting the LC flow. On the other hand, at positive polarity, the same space charge is repelled and diffuses around the shield, effectively weakening the field and suppressing the LC.

As a rule, air gaps break down at nearly the same voltage in repetitive tests, provided the electrodes are not reconditioned, space charge, surface charge or metastables do not accumulate, and the ambient temperature is constant. Such effects were observed in high-repetition-rate pulsed discharges [24], [25]; the gap impedance increased and the breakdown voltage decreased at higher repetition rates. In our measurements, the breakdown

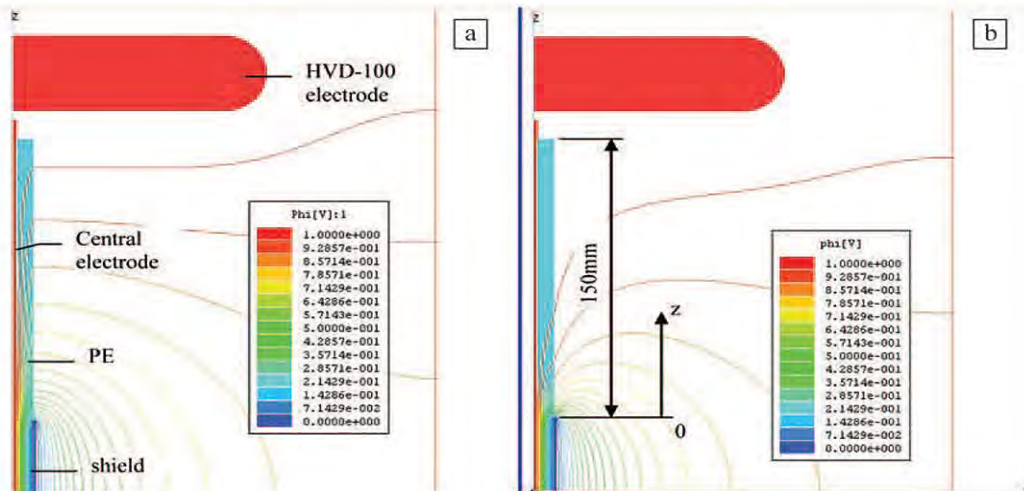
voltages decreased markedly in consecutive tests, suggesting a different breakdown mechanism. The SHTs were punctured after several flashovers and, therefore, did not suppress LCs. It may be that at negative polarity and voltages at which the LCs reach several microamperes, the SHTs are damaged thermally following several flashovers as a result of localized power losses estimated at the subwatt level.

In the context of HV cable terminations, reducing and stabilizing LCs is essential for achieving higher breakdown voltages and greater reliability. There are other important considerations. The current drawn from the PSU is usually stable and is the sum of the load current and various LCs, including that of the cable. The data on the temporal behavior of the LCs presented in this work allow us to assess the level of the load current stability achievable under the cited ambient conditions. Thus, if the LC is of order 1 μA and the load current is 100 μA , one cannot expect stability better than 1%, even if the PSU stability is specified as 0.01%. Similar effects can be caused by dark currents in vacuum gaps [26].

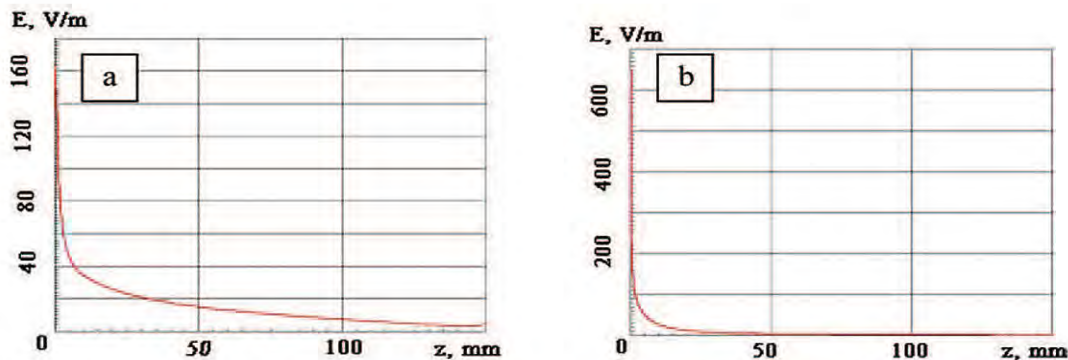

Figure 13. E-field distribution along bare polyethylene starting from cable shield. Plots a and b correspond respectively to the dc and ac cases of Figure 12.

TECHNICAL ARTICLES ABOUT HVPS and HV ELECTRONICS

Research Papers

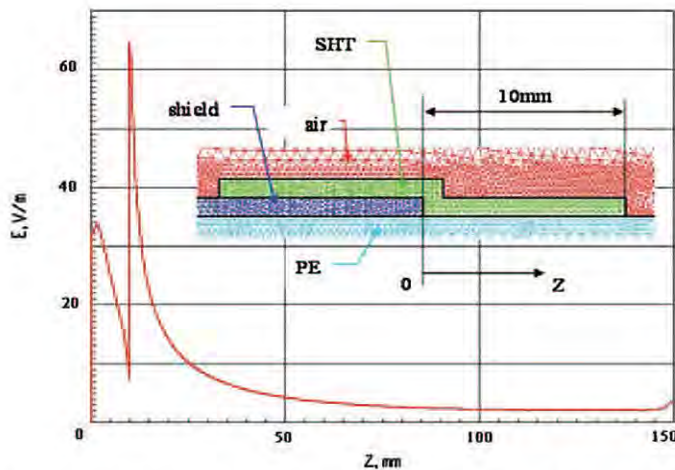

Figure 14. E-field distribution along polyethylene (PE) starting from cable shield, dc case. Polyethylene covered by shrink tube (SHT) 1-mm thick. Inset shows part of meshed geometry. Resistivities of PE, SHT, and air are in the ratio of 100:1:10.

Conclusion

Six different types of 2124 cable shield termination were tested for leakage current and dielectric strength. The main results can be summarized as follows:

- (1) Shrink sleeve strongly affects ionization phenomena, effectively suppressing corona discharge.
- (2) Flush cutting a shield leaves loose short strands, which increase the probability of main insulation damage.
- (3) Folding the shield back over an O-ring decreases the electric field strength, leaves no loose strands, and decreases the probability of main insulation damage. This is recommended for dc applications.
- (4) Stress-grading tapes reduce (and greatly stabilize) leakage currents, at a level around 1 nA at 100 kV and room temperature. They also increase the breakdown voltage to approximately 130 kV for a 15-cm length of insulation. They are recommended for pulsed operation and critical dc applications.

References

- [1] P. N. Nelson and H. C. Hervig, "High dielectric constant materials for primary voltage cable terminations," *IEEE Trans. Power App. Syst.*, vol. PAS-103, no. 11, pp. 3211–321, Nov. 1984.
- [2] J. C. G. Wheeler, A. M. Gully, A. E. Baker, and F. A. Ferrot, "Thermal performance of stress grading systems for converter-fed motors," *IEEE Electr. Insul. Mag.*, vol. 23, no. 2, pp. 5–11, 2007.
- [3] G. C. Stone, E. A. Boulter, I. Culbert, and H. Dhirani, *Electrical Insulation for Rotating Machines*. IEEE Press, Wiley, 2004.
- [4] S. V. Nikolajevic, N. M. Pekaric-Nad, and R. M. Dimitrijevic, "Optimization of cable terminations," *IEEE Trans. Power Del.*, vol. 12, no. 2, pp. 527–532, April 1997.
- [5] G. Lupb, K. Tuoci, N. Femia, and M. Vigielli, "Electric field calculation in HV cable terminations employing heat-shrinkable composites with non linear characteristics," in *Proceedings of the 4th International Conference on Properties and Applications of Dielectric Materials*, Brisbane, Australia, pp. 278–281, 1994.

- [6] J. Mackewich and J. Hoffman, "Insulation enhancement with heat-shrinkable components. Part 11: Shielded power cable," *IEEE Electr. Insul. Mag.*, vol. 7, no. 4, pp. 31–40, 1991.
- [7] <http://www.spellmanhv.com/~lmedia/Files/Products/HVD.ashx>.
- [8] P. Gallagher, *High Voltage: Measurement, Testing and Design*. Chichester, UK: Wiley, 1983, p. 197.
- [9] A. I. Dolginov, *High Voltage Engineering*. Moscow: Energia, 1968.
- [10] M. S. Khalil, "International research and development trends and problems of HVDC cables with polymeric insulation," *IEEE Electr. Insul. Mag.*, vol. 13, no. 6, pp. 35–47, 1997.
- [11] A. Pokryvailo, "Analyzing electric field distribution in non-ideal insulation at direct current," in *Proc. Electrimacs 2008*, on CD-ROM, Quebec, Canada, June 2008.
- [12] Maxwell 2D Student Version, Ansoft Corp., Pittsburgh, PA, 2002.
- [13] J. M. Meek and J. D. Craggs, *Electrical Breakdown of Gases*. Oxford: Clarendon Press, 1953.
- [14] L. B. Loeb, *Electrical Coronas: Their Basic Physical Mechanisms*. Berkeley: University of California Press, 1965.
- [15] K. Parker, *Electrical Operation of Electrostatic Precipitators*. London: IEE, 2003.
- [16] Y. P. Raizer, *Gas Discharge Physics*. Berlin: Springer, 1991.
- [17] G. G. Raju, *Dielectrics in Electric Fields*. New York: Marcel Dekker Inc., 2003.
- [18] Shrink Tubing. Available: <http://www.alphawire.com/pages/114.cfm>.
- [19] M. Beuer, W. Boeck, K. Möller, and W. Zaengl, *Hochspannungstechnik*. Springer-Verlag, 1986, 1992. Translation to Russian 1989 (Moscow: Energoatomizdat).
- [20] E. Kuffel and W. S. Zaengl, *High Voltage Engineering*, 2nd ed., Butterworth-Heinemann, 2000.
- [21] G. I. Skanavi, *Physics of Dielectrics: Weak-Field Region*. Moscow: Gos-tekhnizdat, 1949, pp. 218–219.
- [22] G. I. Skanavi, *Physics of Dielectrics: Strong-Field Region*. Moscow: Fizmatlit, 1958.
- [23] V. Y. Ushakov, *Insulation of High-Voltage Equipment (Power Systems)*. Springer, 2004 (Translation from 1994 Russian ed.).
- [24] Y. Yankelevich, R. Baksht, M. Wolf, A. Pokryvailo, J. Vinogradov, B. Rivin, and E. Sher, "NOx diesel exhaust treatment using pulsed corona discharge: The pulse repetition rate effect," *Plasma Sources Sci. Tech.*, vol. 16, pp. 386–391, 2007.
- [25] A. Pokryvailo, M. Wolf, and Y. Yankelevich, "Investigation of operational regimes of a high-power pulsed corona source with an all-solid state pulser," *IEEE Trans. Dielectr. Electr. Insul.*, vol. 14, no. 4, pp. 846–857, Aug. 2007.
- [26] A. Pokryvailo and V. Okun, "An investigation of stray currents of x-ray tubes having tubular hollow anodes," *Instrum. Methods X-Ray Anal.*, vol. 32, pp. 120–126, 1984 (in Russian).



Alex Pokryvailo was born in Vyborg, Russia. He received his MSc and PhD degrees in electrical engineering from the Leningrad Polytechnic Institute in 1975 and 1987, respectively. Formerly with Soreq NRC, Israel, he is now working with Spellman High Voltage Electronics Corp. His current and recent experience relates to pulsed power, with emphasis on high-current opening and closing switches and magnetic design, fast diagnostics, design of HV high-power switch-mode power supplies, and corona discharges. Previously he studied switching arcs, designed SF₆ insulated switchgear, and carried out research in the area of interaction of flames with electromagnetic fields. He has published over 100 papers and 2 textbooks (in Hebrew) and holds more than 20 patents pertaining to HV technology.



A High-Power, High-Voltage Power Supply for Long-Pulse Applications

Alex Pokryvailo, Senior Member, IEEE, Costel Carp, and Cliff Scapellati

Abstract—This paper describes a concept and a physical demonstration of a high-efficiency small-size low-cost 100-kV 100-kW high-voltage (HV) power supply (HVPS) designed for long-pulse applications (units of milliseconds to dc operation). Key technology includes a modular HV converter with energy-dosing inverters that run at about 50 kHz and have demonstrated an efficiency of 97.5% across a wide range of operating conditions. The inverters' output voltages are phase shifted, which yields a low ripple of 1% and a slew rate of 3 kV/ μ s combined with less than 10 J of stored energy at the maximum voltage. Modular construction allows easy tailoring of HVPS for specific needs. Owing to high efficiency, small size is achieved without water cooling. Controls provide standard operating features and advanced digital processing capabilities, along with easiness of accommodating application-specific requirements. HVPS design and testing are detailed. It is shown that the ripple factor is inversely proportional to the number of modules squared. Experimental current and voltage waveforms indicate virtually lossless switching for widely varying load in the full range of the line input voltages and fair agreement with circuit simulations. The overall efficiency is as high as 95% at full load and greater than 90% at 20% load, with a power factor that is typically greater than 93%.

Index Terms—Power electronics, pulsed power, resonant converter, voltage multiplier, voltage ripple.

I. INTRODUCTION

PULSED-POWER science and technology have accumulated many means of pulse generation in a wide range of parameters, with duration from picoseconds to seconds at power levels going up to terawatts for shorter pulses. A recent book by Mesyats [1] can serve as an encyclopedia on this subject. With the focus on *rectangular* millisecond-to-second durations, ubiquitous in X-ray tomography, RF sources, ion implantation, etc., the most common methods are using pulse-forming networks (PFN) or dc power supplies, self-modulated or having high-voltage (HV) switches for modulating the output voltage level. Obviously, PFNs are better suited for the generation of shorter pulses, and dc modulation is the only practical means of forming longer multimillisecond-to-several-seconds duration pulses with fast transitions. We include a single storage capacitor with a fully controlled output switch and inductive energy storage systems [2], [3] in the PFN category.

Manuscript received September 22, 2009; revised January 4, 2010; accepted February 25, 2010. Date of publication April 12, 2010; date of current version October 8, 2010.

The authors are with Spellman High Voltage Electronics Corporation, Hauppauge, NY 11788 USA (e-mail: Apokryva@spellmanhv.com; ccarp@spellmanhv.com; cliff@spellmanhv.com).

Color versions of one or more of the figures in this paper are available online at <http://ieeexplore.ieee.org>.

Digital Object Identifier 10.1109/TPS.2010.2044810

The ability to provide fast rise time is beneficial also in electrostatic precipitation (ESP) applications. Heavy sparking inherent to the ESP operation results in frequent voltage collapses, and fast power restoration improves the collection efficiency [4], [5]. The same is true in the case of intermittent energization.

A typical requirement for dc HV power supplies (HVPSs), including but not limited to long-pulse applications, is the reduction of the output stored energy below a certain level, simultaneously meeting a contradicting requirement of keeping the voltage ripple as low as possible. The most promising approach to satisfy these conditions economically is using high-frequency (HF) multiphase topologies in their various incarnations. Closed-loop feedback circuits, in principle, can provide tight regulation and compensate for the line voltage variations, such as droop and line-frequency ripple, although it is not simple to ensure both clean and fast transitions without overshoots and high stability at a dc level. In order to realize high efficiency, almost universally, the converter part makes use of resonance to avoid switching losses. The theory and practice of such converters are known well [6], [7]. Very high power systems have been developed around three-phase HV transformers having individual or common cores [8]–[10] that operate typically at 20 kHz. A natural way for the voltage/current adjustment in such converters is frequency regulation.

We favor a modular approach that makes use of multiple phase-shifted individual transformers, each having its rectifying circuit [11], [12]. In this way, the system design is flexible and open, with the possibility of choosing the desired number of phases for the ripple suppression. This paper widens this concept and describes a physical demonstration of an ultrahigh-efficiency small-size low-cost 100-kV 100-kW HVPS designed for long-pulse applications. It is also suitable for ESP and similar markets.

II. SHORT SPECIFICATIONS

This section is intended as a short introduction to the following material, giving a brief outline of the specifications that guided the development and have been largely met or exceeded. The emphasis is on the dynamic characteristics combined with high power. The main specifications are as follows:

- 1) average output power: 100 kW in an output voltage range of 90–100 kV; derated at lower voltage;
- 2) dynamic response: a slew rate of 100 kV/ms minimum (5% to 95% of preset voltage); typically 300 kV/ms;

TECHNICAL ARTICLES ABOUT
HVPS and HV ELECTRONICS

Research Papers

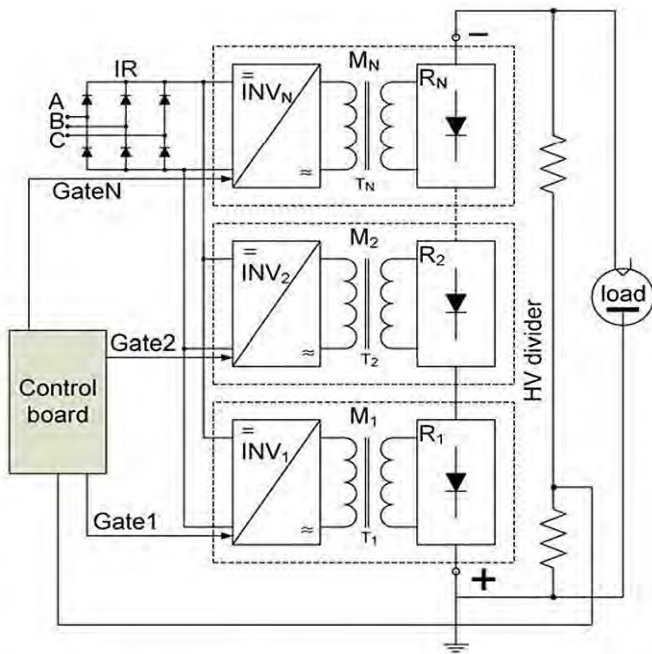

Fig. 1. HVPS block diagram.

- 3) HF ripple component, peak to peak (p-p): 1% typically at 100 kV at full power;
- 4) output stored energy: < 10 J;
- 5) conversion frequency: 50 kHz;
- 6) input voltage: three-phase 400 VAC^{+10%}_{-14%};
- 7) power efficiency: typically > 95% at full power at 100 kV; > 90% at 20 kW;
- 8) overall weight: < 250 kg; oil volume less than 60 L.

III. KEY TECHNOLOGY

The HVPS is built around a modular HV converter (Fig. 1). All converter modules $M_1 - M_N$ are fed from a common input rectifier (IR). The modules comprise inverters $INV_1 - INV_N$ feeding HV transformers $T_1 - T_N$ that feed voltage multipliers $R_1 - R_N$ having M multiplication stages, which voltages are summed by their dc outputs. Such topology may be termed as “inductive adder.” For the 100-kV 100-kW rating, $N = 4$, and $M = 3$. Each module is built for 25-kV 25-kW average power and has high-potential insulation of the secondary winding of the transformer rated at $3 \cdot 25 \text{ kVDC} = 75 \text{ kVDC}$. This insulation, along with the rest of the components (mainly HV capacitors), must also withstand transient voltages arising during the pulsing. The number of such transients is determined by the HVPS operating scenario. For instance, in ESP applications, the number of pulses during the lifetime is determined by the sparking rate. If the latter is 6 sparks/min, the number of shots may well exceed 10^7 .

The topology Fig. 1 was suggested and partially investigated long ago [11], [12]. It allows reduction of both the number of multiplier stages and the voltage rating of the HV transformer. The first improves the compression ratio (the ratio of

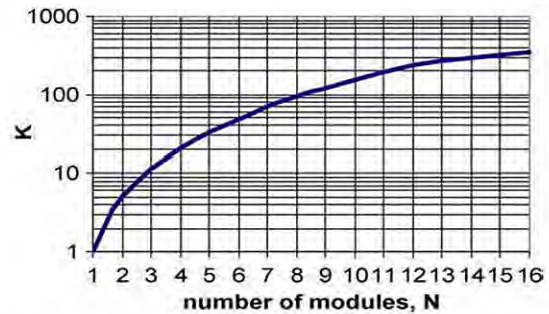

Fig. 2. Ripple suppression factor.

the voltage across the first multiplier stage to that of the last) and reduces drastically the stored energy. With $M = 3$, the transformers and multiplier boards are rated at 8.5 kV, which simplifies their design and greatly reduces the insulation stress caused by the HF voltage component. The phase shift of the inverters’ output voltages results in the decrease of the output ripple and in the additional reduction of the stored energy. In this approach, the development costs and time are driven down, noting that, once a single module has been developed (including its main insulation), the whole converter is realized by a simple combination of the desired number of modules that may be connected both in series and in parallel. The penalty is larger part count and the necessity of the high-potential main insulation that is not required in conventional Cockroft-Walton multipliers. However, this insulation is stressed mainly by a dc voltage and therefore ages much slower compared to an HF (tens of kilohertz) stress [13]. Under pulsed operation, the main insulation is also subjected to pulse voltages.

A. Ripple Suppression

Let us define the ripple suppression factor K as the ratio of the ripple of the HVPS comprising N modules operating in-phase V_{Nrs} to that having N phase-shifted modules V_{Ns} . The ripple can be regarded as the p-p voltage of the HF ac component or can be represented in percent of the dc component. For simplicity sake, we will assume here that the rectified voltage of each module is a superposition of a dc component and a modulus of a sine wave.

The ripple suppression factor can be easily calculated; it is shown in a graphical form in Fig. 2. It is shown that, for the analyzed case, K is proportional to N^2 . For arbitrary ripple waveforms, this dependence is more complicated. In general, K can be estimated using the formula $K = \alpha \cdot N^\beta$, where the waveform-dependent coefficient $\alpha \approx 1 \div 1.3$ and the exponent $\beta = 1 \div 2$. For a rectified sine wave, $\alpha \approx 1.3$ and $\beta = 2$, as shown in Fig. 2, whereas for a sawtooth ripple defined, for instance, by a function $v(t) = -t + \text{ceil}(t)$, $\alpha = 1$ and $\beta = 1$ (this statement can be also easily verified graphically).

If the ripple factor is specified, the phase shift imparts approximately N to N^2 reduction of the rise time, output capacitance, and the stored energy. Thus, the described multicell concept enables the HVPS optimization in the space of the aforementioned parameters.

TECHNICAL ARTICLES ABOUT HVPS and HV ELECTRONICS

Research Papers

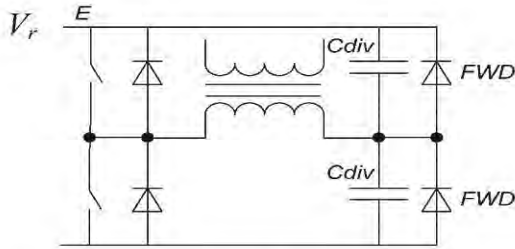

Fig. 3. Half-bridge inverter with energy-dosing capacitors. V_r denotes the dc rail supply voltage.

B. Individual Module Design

The converter cells are centered around half-bridge energy-dosing quasi-resonant inverters (Fig. 3). The principle, theory of operation, benefits, and shortcomings were described elsewhere [14] (see also the accompanying paper [15] and its references), and we do not expand the description here.

The inverters operate at approximately 50 kHz at full load with virtually zero switching losses. The leakage inductance of the HV transformers is fully incorporated into the resonant tank circuits; thus, no external inductors are necessary. Aside from lowering the part count and cost, this feature is highly beneficial for the chosen multicell resonant topology, since leakage inductance is well repeatable from sample to sample and, being determined by the flux concentrated outside the ferromagnetics, virtually does not depend on temperature. The parasitic capacitance of the transformer has larger technological tolerances. It is also more sensitive (than the leakage inductance) to the transformer-rectifier position. However, these factors can affect the voltage sharing between the modules only at a no-load scenario, and by a proper choice of the conversion frequency, this effect can be nullified [16].

C. Control

The control board is based around FPGA. It provides standard operating features and advanced digital processing capabilities, along with the easiness of accommodating application-specific requirements. The standard features include multiple protections (arc/spark, overheat of the major components, overcurrent and overvoltage, etc.) and means of voltage and current setting. The output regulation is accomplished by the frequency control and is realized digitally, with the FPGA forming the transistors' conduction intervals to realize ZCS. In such a way, the switching losses are virtually eliminated, which allows using relatively slow inexpensive transistors having low saturation voltage; the latter also boosts the inverter efficiency.

The feedback loop taking the control signal from a precision high-bandwidth built-in HV divider is optimized for fast transitions with minimal or no overshoot (see experimental sections hereinafter) and tight stabilization after the voltage settling. We note here that full-scale HVPS PSpice models were developed. They adequately reproduce all salient features of the HVPS operation, including parasitic components of the HV part, the phase-shift mechanism, feedback circuit, etc., assisting in both the design and interpretation of the experimental data.

IV. EXPERIMENTAL

A. Measurement Means and Experimental Methods

For the HF current measurement, specialty workshop-made current transformers with a sensitivity of 0.01 V/A (designated further in the text as CC1) and Rogowski probes of PEM make, model CWT15 [17], were used. The latter were also used for the CC1 calibration. A standard high-precision Spellman voltage divider (model HVD100 [18]) served for the HVDC measurement. A modified, compensated, and calibrated version, designated as HVD100C, was used for the transient measurements. Its rise time is less than 2 μ s. The ripple was monitored by a specialized ripple checker comprising a blocking capacitor in series with a resistor [19], the voltage across which was measured by a P6015A Tektronix probe. Although the ripple did not exceed 1 kV at dc operation, such HV probe was needed to accommodate much higher transient voltages during turn-on. Floating voltage measurements were performed by a differential Tektronix probe P5200. A specialized nonlinear divider (workshop made) was used for the measurement of saturation voltages across the semiconductor switches [20]. Power measurements [efficiency and power factor (PF)] were taken with a Voltech power meter, model PM300. Temperatures were monitored by thermocouples connected to an Agilent data logger, model 34970A, with supporting BenchLink software.

The input line voltage was regulated manually with a three-phase variac in tests with a single module, at a power level of less than 30 kW. Thus, the input voltage could be adjusted continuously. At higher power, a three-phase line-frequency transformer with switchable taps was used. It allowed the simulation of the scenarios of low-, nominal-, and high-line input voltages. The latter were not stabilized and varied slightly during the runs. The point of measurement was the dc rail supply voltage V_r . In this paper, the values of the latter corresponding to the aforementioned scenarios are defined as the ranges from 460 to 480 V, 510 to 530 V, and 580 to 600 V for the low-, nominal-, and high-line input voltages, respectively. The V_r variation from 460 to 590 V corresponds to the three-phase 400 VAC^{+10%}_{-14%} line factoring in the voltage drop in the IR.

B. Single Module Tests

Typical waveforms shown in Fig. 4 indicate good resonant switching with no shoot-through currents in the full range of the line input voltages, and fair agreement with PSpice simulations. In this and the following figures, the inset notes indicate test conditions, types of the probes used, horizontal and vertical resolutions, etc. The primary winding was divided into two sections connected in parallel, each commutated by a transistor set, hence the notation "halved" in this and the following figure captions. The dashed line shows the start of the FWD conduction. At low line, the FWDs do not conduct at all. These measurements were performed with the Powerex IGBTs CM300DC-24NFM. The power losses were assessed at 50 W per transistor, and the heat was easily evacuated using air-cooled heat sinks with an overheat of less than 40 °C above

TECHNICAL ARTICLES ABOUT HVPS and HV ELECTRONICS

Research Papers

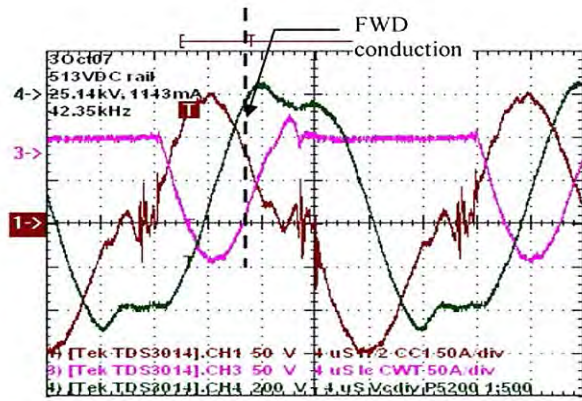

Fig. 4. Nominal line. $P = 28.7$ kW. (Trace 1) Primary winding current (halved). (Trace 3) Collector current (halved). (Trace 4) Voltage across resonant capacitors. FWD conducts to the right of the dotted line.

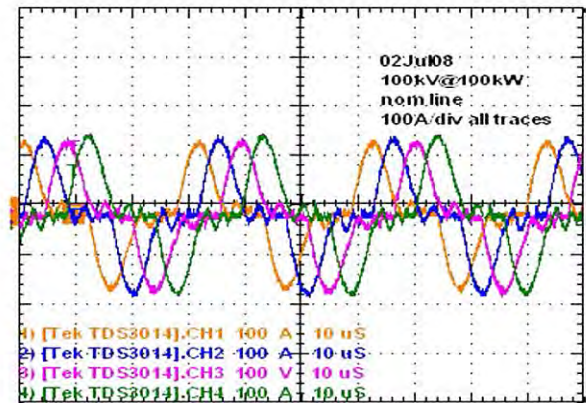

Fig. 6. $\pi/4$ -phase-shifted primary winding currents (halved) at 100 kV and 100 kW. Nominal-line voltage: 400 VAC.

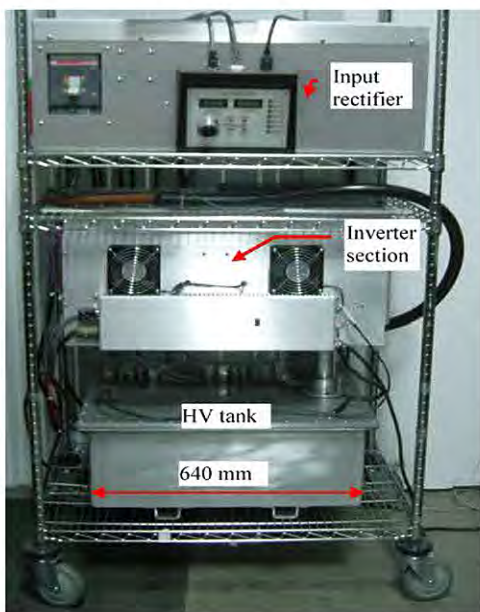

Fig. 5. Laboratory HVPS.

ambient under the harshest conditions. The methods of power-loss measurement and calculation are detailed in [20].

Special attention was paid to the determination of the HV transformer and multiplier losses. This was a key to the design of the HV tank. With this purpose, the calorimetric measurements of the losses of the converter module HV components were performed. The converter efficiency was estimated at 97.5%; thus, an overall efficiency of 95% of the whole HVPS was projected. In view of the expected high efficiency, it was decided to adopt an all-air-cooling scheme without any heat exchangers.

C. HVPS Tests

A laboratory HVPS was assembled on a cart, as shown in Fig. 5. It comprises three main units: a circuit-breaker-protected

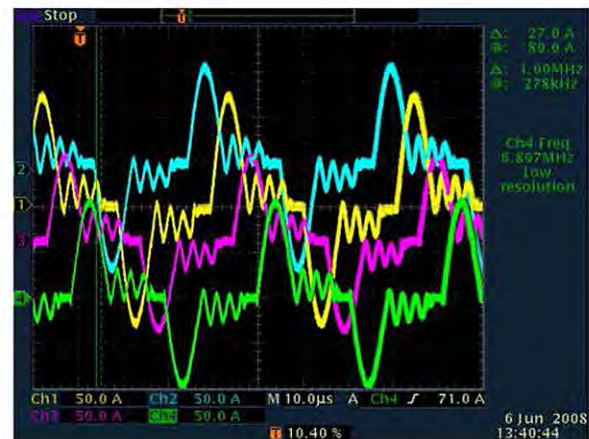

Fig. 7. Same as in Fig. 6 at 100 kV and 50 kW. Low-line voltage: 400 VAC-14% (345 VAC).

line rectifier (the heaviest unit), an inverter section, and a hermetically sealed oil-filled HV tank. The latter weighs 109 kg and contains less than 60 L of oil. We note that, in this paper, the emphasis was on the converter part; the line rectifier was not optimized for size and cost.

The HVPS was extensively tested with resistive loads. Figs. 6 and 7 show typical phase-shifted primary winding currents (halved) for 100- and 50-kW operations, respectively. The oscillations after the main current surge are generated by the resonance between the leakage inductance and parasitic capacitance of the transformers. Note the absence of the “backswing” current pulse; the latter characterizes true series resonant schemes under light load.

Since a full-wave rectification scheme is used, the phase shift between the transformer windings’ currents is $\pi/4$. PSpice calculations predict 0.223% output voltage p-p ripple with an HVPS shock (output) capacitance of < 2 nF at the worst case of high line (Fig. 8). The measured ripple is roughly four times larger and has a lower frequency fundamental component (Fig. 9). The emergence of the latter can be attributed to the asymmetry of the gate signals, unequal parasitic capacitances,

TECHNICAL ARTICLES ABOUT HVPS and HV ELECTRONICS

Research Papers

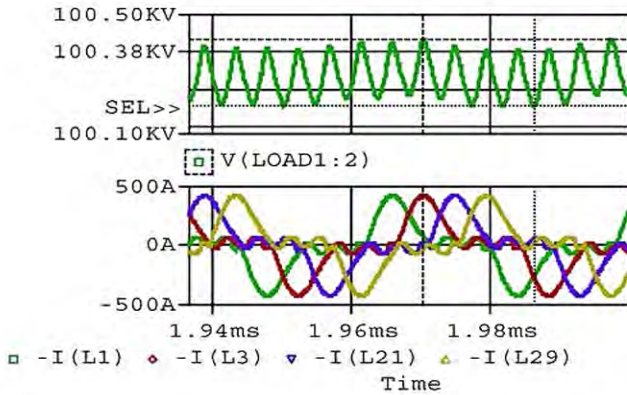

Fig. 8. HVPS circuit simulation. High-line voltage: $V_r = 580$ V. Ripple: 0.223% p-p. $PF = 0.943$. Experimental $PF = 0.946$ (see Fig. 11).

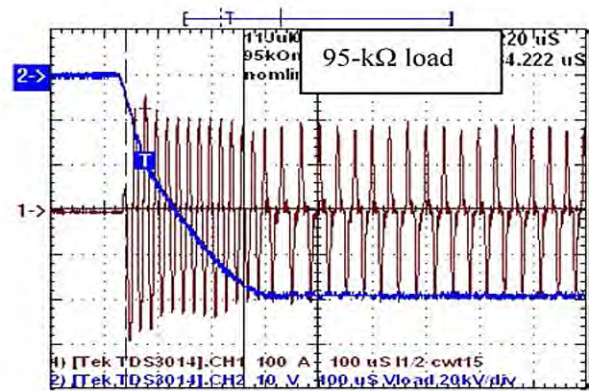

Fig. 10. Rise time across 95-kΩ load at nominal line. (Trace 2) Load voltage: 20 kV/div (measured by a specially compensated voltage divider). (Trace 1) Primary current (halved): 100 A/div.

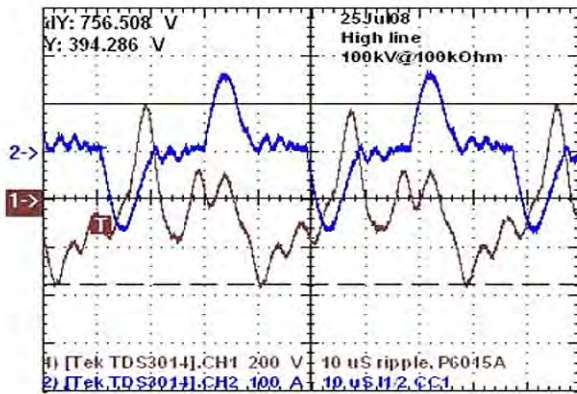

Fig. 9. Ripple at 100 kV across 100-kΩ load is 0.76% p-p. High line.

spread in the winding data, nonideal feedback, etc. Similar effect was observed in [12]. The aforementioned simulations provide also a value of the PF of 0.943, which is close to the experimental results. Note that the ripple wave shapes are neither a rectified sine wave nor sawtooth; they are but closer to the first pattern; thus, the value for the exponent in (4) can be adopted as $\beta = 2$. This is borne out by numerous measurements and simulations in a wide range of the load impedances and output voltages. Again, poor feedback can strongly affect the ripple suppression by the phase shift.

Accounting for a very conservative voltage rating of the HV transformers and low ripple, the dynamic response of the HVPS is exceptionally fast: The rise time from zero to full output voltage is typically less than 250 μ s (Fig. 10), depending on the line voltage. With fair accuracy, the dynamic characteristics in the energy-dosing mode can be analyzed using [14]

$$V_i(t) = 2V_r \sqrt{\frac{C_{div}}{C_s} ft} \quad (1)$$

where all the variables and parameters are reflected on the same side of the transformer; t is the time, f is the conversion frequency, and C_s is the overall capacitance of the module multiplier and load. If the frequency is varied during the charge, PSpice simulations provide better accuracy. Obviously, the rise

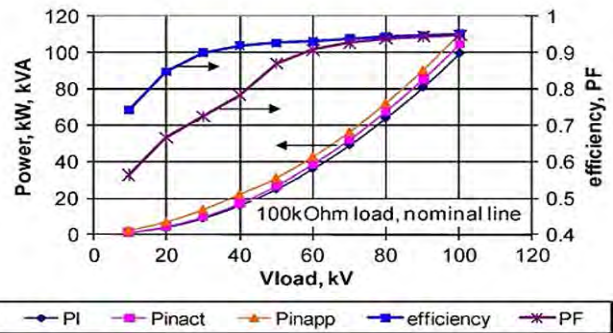

Fig. 11. Apparent (Pin_{app}) and active (Pin_{act}) input powers, load power (PI), efficiency, and PF at nominal line for 100-kΩ load.

time, as derived from (1), the output stored energy, and the ripple factor are inversely proportional to C_s . Thus, allowing for a 2-% ripple factor at full voltage and full power, the rise time can be reduced to less than 100 μ s. We note that the rise time practically does not depend on the load, since the load current is by an order of magnitude smaller than the current charging the multiplier capacitors.

Fig. 11 shows the experimental data on the power measurements obtained at the nominal line. In accordance with the simulations and information derived from the work with the single module, the overall efficiency is 95% at full load and is greater than 90% at 20% load. The PF was also satisfactorily high. At high and low lines, the measurements yielded very similar results. At higher resistance load, the efficiency and PF were virtually the same (Fig. 12).

The long-term runs at 100 kV have been performed up to a power level of 100 kW (average continuous power). In order to establish the overload capability, the HVPS was also run with three modules at 88.4 kV, 90 kW, and in a pulsed mode (see the following). Conservative overheating of the major HVPS components was observed. For the nominal line, the results are summarized in Table I.

The HVPS was also tested in a pulsed mode, mainly with the goal of validating the lifetime of the main insulation. The HVPS-generated 110-kV rectangular pulses with a period of

TECHNICAL ARTICLES ABOUT
HVPS and HV ELECTRONICS

Research Papers

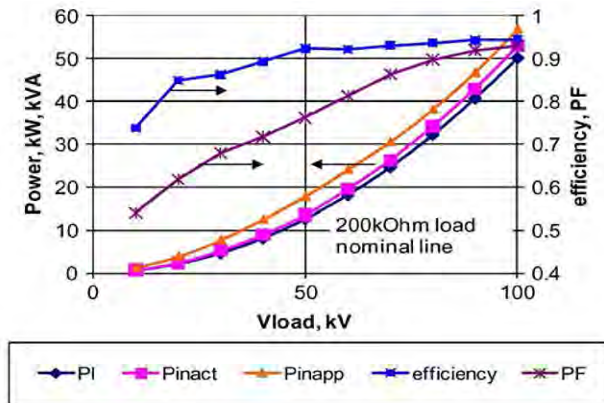

Fig. 12. Same as in Fig. 11 for 200-kΩ load.

 TABLE I
OVERHEAT OF MAJOR HVPS COMPONENTS, °C

load power, kW	transistor baseplate	FWD baseplate	HV tank (bulk oil)
100 (4 modules)	25	23	42
90 (3 modules)	27	10	38

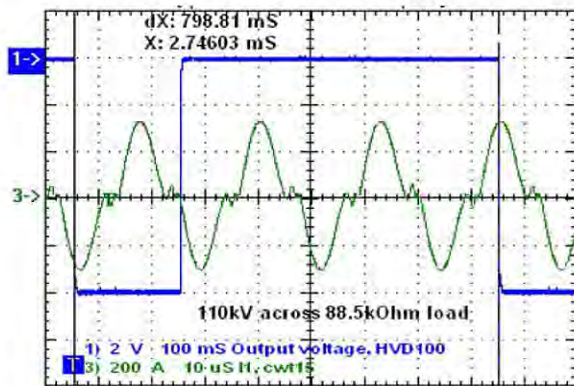

Fig. 13. Long-pulse operation: 110 kV, 137-kW peak power, and 34-kW average power. (Trace 1) Load voltage and (trace 3) primary current (after voltage settling) are shown on different timescales. Nominal line.

0.8 s and a pulsewidth of 0.2 s across an 88.5-kΩ load, which corresponds to 137-kW peak power and 34-kW average power, respectively (see Fig. 13). At the time of writing this paper, a total of $1.1 \cdot 10^6$ pulses have been generated.

Additional pulse tests were made with a capacitive load imitating large ESP fields. With this purpose, a 0.4-μF capacitor was connected across a 180-kΩ load. The experiments were conducted at a repetition rate of ~0.2 Hz. The rise time from zero to 100 kV was 20 ms.

The unit was also tested for spark/arc withstand capability. It was repetitively shorted to ground at full voltage. No damage was sustained, also after intermittent sparking in the course of the tests. We note that the arc/spark protection is provided by a proprietary $L-R$ network limiting the current derivative and amplitude without significant power dissipation in this network (less than 10 W) in normal operation.

V. CONCLUSION

An HVPS for long-pulse applications has been developed. It was extensively tested in a wide range of resistive and capacitive loads. The HVPS salient features are as follows:

- 1) multiphase topology and modular construction allow easy and fast tailoring of HVPS for specific needs;
- 2) exceptionally low ripple and fast rise time combined with low stored energy;
- 3) high efficiency and PF in a wide range of output parameters;
- 4) all-air-cooled design;
- 5) small size, weight, and footprint; small oil volume.

It is foreseen that the described approach will be widely implemented in HVPS for long-pulse applications, particularly for X-ray computer tomography scanners.

ACKNOWLEDGMENT

The authors would like to thank their colleagues at Spellman for the massive support of this paper, particularly Mr. A. Lipovich for his contribution to the mechanical design and Mr. A. Silverberg for the FPGA programming of the phase-shift algorithm.

REFERENCES

- [1] G. A. Mesyats, *Pulsed Power and Electronics*. Moscow, Russia: Nauka, 2004, Translation to English: "Pulsed Power," Kluwer, NY, 2005.
- [2] M. Kanter, S. Singer, R. Cerny, and Z. Kaplan, "Multikilojoule inductive modulator with solid-state opening switches," *IEEE Trans. Power Electron.*, vol. 7, no. 2, pp. 420–424, Apr. 1992.
- [3] A. Pokryvailo, I. Ziv, and M. Shapira, "Repetitive inductive storage power supply for ETC tank gun," *IEEE Trans. Magn.*, vol. 39, no. 1, pp. 257–261, Jan. 2003.
- [4] K. Parker, *Electrical Operation of Electrostatic Precipitators*. London, U.K.: IEE, 2003.
- [5] Advanced Electrostatic Precipitator (ESP) Power Supplies Update: The State-of-the-Art of High-Frequency Power Supplies. EPRI, Palo Alto, CA, 2006, 1010361.
- [6] M. K. Kazimierzczuk and D. Czarkowski, *Resonant Power Converters*. New York: Wiley, 1995.
- [7] R. Erickson and D. Maksimovic, *Fundamentals of Power Electronics*, 2nd ed. New York: Springer-Verlag, 2001.
- [8] W. A. Reass, D. M. Baca, R. F. Gribble, D. E. Anderson, J. S. Przybyla, R. Richardson, J. C. Clare, M. J. Bland, and P. W. Wheeler, "High-frequency multimegawatt polyphase resonant power conditioning," *IEEE Trans. Plasma Sci.*, vol. 33, no. 4, pp. 1210–1219, Aug. 2005.
- [9] M. J. Bland, J. C. Clare, P. W. Wheeler, and R. Richardson, "A 25 kV, 250 kW multiphase resonant power converter for long pulse applications," in *Proc. IEEE Pulsed Power Plasma Sci. Conf.*, 2007, pp. 1627–1630.
- [10] M. J. Bland, J. C. Clare, P. Zanchetta, P. W. Wheeler, and J. S. Przybyla, "A high frequency resonant power converter for high power RF applications," in *Proc. Eur. Power Electron. Conf.*, 2005, pp. 1–10.
- [11] H. Baumann, "X-ray diagnostic generator," U.S. Patent 4375 105, Feb. 22, 1983.
- [12] Y. Petrov and A. Pokryvailo, "HV DC-to-DC converter," *Prib. Tekh. Eksp.*, vol. 2, pp. 141–143, 1986.
- [13] V. Y. Ushakov, *Insulation of High-Voltage Equipment (Power Systems)*. New York: Springer-Verlag, 2004 (Translation from Russian ed. 1994).
- [14] B. Kurchik, A. Pokryvailo, and A. Schwarz, "HV converter for capacitor charging," *Prib. Tekh. Eksp.*, no. 4, pp. 121–124, 1990.
- [15] A. Pokryvailo, C. Carp, and C. Scapellati, "High power, high efficiency, low cost capacitor charger concept and demonstration," in *Proc. 17th IEEE Int. Pulsed Power Conf.*, Washington, DC, Jun. 29–Jul. 2, 2009, pp. 801–806.
- [16] A. Pokryvailo, "On electromagnetic processes in HV transformers of switching-mode power supplies at no-load conditions," in *Proc. 27th Int. Power Modulators Symp.*, Arlington, VA, May 14–18, 2006, pp. 287–290.
- [17] [Online]. Available: http://www.pemuk.com/pdf/cwt_mini_0605.pdf
- [18] [Online]. Available: <http://www.spellmanhv.com>

TECHNICAL ARTICLES ABOUT HVPS and HV ELECTRONICS

Research Papers

- [19] *IEEE Standard Techniques for High Voltage Testing*, IEEE Std-4-1995, section 5.1.5.
- [20] A. Pokryvailo and C. Carp, "Accurate measurement of ON-state losses of power semiconductors," in *Proc. 28th Int. Power Modulators Symp.*, Las Vegas, NV, May 27-31, 2008, pp. 374-377.

Costel Carp, photograph and biography not available at the time of publication.

Clifford Scapellati, photograph and biography not available at the time of publication.



Alex Pokryvailo (M'05-SM'07) was born in Vyborg, Russia. He received the M.Sc. and Ph.D. degrees in electrical engineering from the Leningrad Polytechnic Institute, St. Petersburg, Russia, in 1975 and 1987, respectively.

He was with Soreq NRC, Yavne, Israel. He is currently with Spellman High Voltage Electronics Corporation, Hauppauge, NY. He has published over 100 papers, two textbooks (in Hebrew), and more than 20 patents pertaining to HV technology. His current and recent experiences relate to pulsed power,

with emphasis on high-current opening and closing switches and magnetic design, fast diagnostics, the design of HV high-power switch-mode power supplies, and corona discharges. Previously, he studied switching arcs, designed SF₆-insulated switchgear, made research in the area of interaction of flames with electromagnetic fields, etc.

Comparison of the Dielectric Strength of Transformer Oil Under DC and Repetitive Multimillisecond Pulses

Key words: transformer oil, millisecond pulses, high voltage, power supply

Introduction

The dielectric strength of insulating liquids in general, and of transformer oil in particular, is of great practical interest and has been studied extensively for more than a century [1]–[6]. Reference [7] focuses on the impulse breakdown of liquids over a wide range of parameters and is particularly relevant to the work presented in this article.

It is well known that the dielectric strength of fresh, thoroughly purified (filtered, degassed, dehumidified) oil is several times higher than that of aged, contaminated oil, except under nano- or picosecond pulses. Some of the reasons for this difference are as follows: (1) under the influence of an electric field, solid impurity particles or water may form a chain and initiate breakdown [1]; (2) solid impurities can be generated in oil as the result of accidental or intentional arcs, or oxidation of metals; (3) water may be absorbed from the atmosphere in non-hermetically sealed devices.

The various breakdown mechanisms have been discussed extensively [1]–[7]. In highly purified liquids, breakdown is usually governed by micro-defects, e.g., gas cavities of nano- and micrometer size trapped on electrode surfaces and in bulk liquid. Even in the absence of micro-bubbles, a transition from liquid to gas can occur owing to heating by electrons field-emitted from the cathode. Because the dielectric strength of a gas is much lower than that of the corresponding liquid, discharge is initiated in the gas and can progress to full breakdown through the bulk liquid. For details, see Ch. 2 of [7]. In contaminated, aged liquids, breakdown mechanisms are less subtle, e.g., a mechanism in which foreign particles tend to align along the electric field lines, building a bridge that initiates discharge. However, this mechanism operates typically on millisecond time scales because of the slow associated particle movement [4]–[7].

Oil degrades considerably in equipment that has been in service for extended periods. In equipment with sealed tanks, e.g., x-ray monoblocks [8], the oil would probably not be changed during the lifetime of the equipment. In such circumstances, breakdown mechanisms and the dielectric strength of purified

A. Pokryvailo and C. Carp

Spellman High Voltage Electronics Corporation, 475 Wireless Boulevard Hauppauge, NY 117

The dielectric strength of fresh and contaminated transformer oil under repetitive millisecond pulses was compared with that at DC voltage. The pulsed breakdown voltage was found to be higher than its DC counterpart by 10 to 20%.

fresh oil are irrelevant, except possibly for the initial choice of oil. Working field stress is chosen on the basis of expected breakdown stress at the end of the service lifetime. A vast database exists on the dielectric strength of fresh and aged oils under DC, AC, and pulsed stress, e.g., [1]–[7] and their references.

As with any dielectric, the breakdown voltage (BV) of liquids tends to increase under short pulses, although not consistently [5], [9]. It was reported in an early investigation [9] that, for transformer oil, the BVs under pulses of several milliseconds duration and very low pulse repetition rates (PRRs) were higher than for AC (60 Hz) by a factor of approximately 1.5 to 2, with larger increases for shorter pulses.

In some equipment, oil is subjected to repetitive pulse stress. Despite the huge amount of breakdown voltage data, we could not find an explicit comparison of the dielectric strength of oil at AC or DC voltages with that under repetitive millisecond pulses.

TECHNICAL ARTICLES ABOUT
HVPS and HV ELECTRONICS
Research Papers

Table 1. High-Voltage Power Supply Basic Specifications.	
Input voltage	90 to 264 VAC, 50/60 Hz (or 0 to 420 VDC if bypassing input rectifier and power factor corrector)
Output voltage	0 to 160 kV (0 to ±80 kV bipolar symmetric to ground)
Output current	0 to 12 mA
Pulse repetition rate	DC, or single shot up to 150 Hz (limited by fall time)
Rise time to nominal voltage	<1 ms without shielded HV cables
Output capacitance	About 30 pF (not including shielded HV cables)
Fall time	Load and HV cable dependent
Ripple, peak to peak	<2%
Conversion frequency	150 kHz
Size	15.7 × 34.3 × 45.7 cm
Insulation	Transformer oil

Because the insulation thickness in equipment used for many specialized applications, e.g., x-ray machines, is much less than that commonly found in power equipment, e.g., transformers and switchgear, information on dielectric strength under repetitive millisecond pulses is important. These two factors motivated the investigation reported below.

Setup and Methods

A. High-Voltage Power Supply

The basic parameters of the custom-designed switch-mode high-voltage power supply (HVPS) are summarized in Table 1. It generates bipolar voltage pulses symmetrical to ground (zero to ±80 kV) at PRRs up to 150 Hz. Arc fault detection and consequent shutdown are provided. Although the HVPS can be fed directly from mains, we preferred feeding its DC-to-DC converter from a regulated DC power supply (one of a Spellman SL series [10]). This enabled greater HV control flexibility. The output was delivered through two shielded cables, each approximately 3 m in length, or by two unshielded cables, each approximately 2 m in length. The importance of specifying the output exactly is that the HV cable capacitance affects the pulse fall time greatly, thus limiting the PRR.

The HVPS with unshielded polyethylene cables attached is shown in Figure 1, along with two function generators setting the PRR and ramp rate (see Test Procedures below). It is a standard Spellman package comprising low-voltage (LV) and high-voltage (HV) sections. The LV section contains a line rectifier, power factor corrector, inverter, and control board. The HV unit houses the HV transformers, multipliers, feedback dividers, et cetera, and is oil-insulated.

A typical negative pole output relative to ground at full voltage (75 kV, or 150 kV between the poles), as measured by the feedback divider, is shown in Figure 2. The flatness of the bottom of the pulse, as observed in calibration tests against a Tektronix P6015A HV probe (Tektronix Inc., Beaverton, OR) up to 40 kV, is better than that shown in Figure 2. The limiting

factor in raising the PRR is the discharge time of the cables. (The multiplier capacitance of approximately 30 pF can be neglected.)

B. Device Under Test

We chose a sphere-to-plane spark gap (SG) configuration to imitate the operational conditions of x-ray tubes and other HV parts in oil. The field nonuniformity factor f , defined as

$$f = E_m / E_{av} \tag{1}$$

where E_m and E_{av} are respectively the maximum and the average field in the gap, would be typically in the range of 1.5 to 6 in the imitated systems. The lower values relate to large, low-curvature

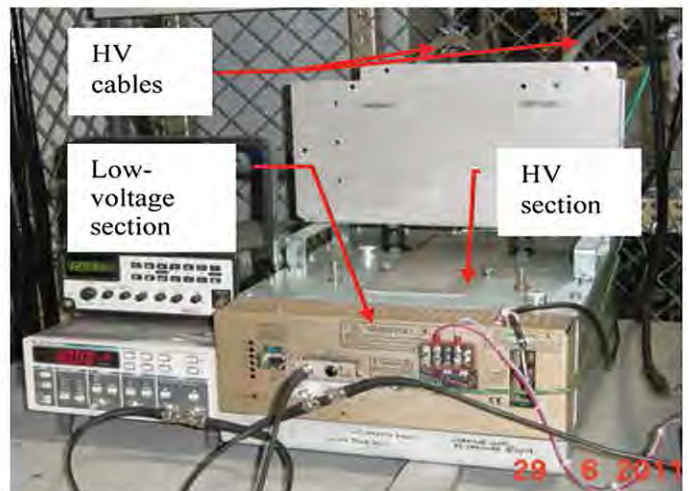

Figure 1. High-voltage power supply (HVPS) with unshielded polyethylene cables.

TECHNICAL ARTICLES ABOUT HVPS and HV ELECTRONICS

Research Papers

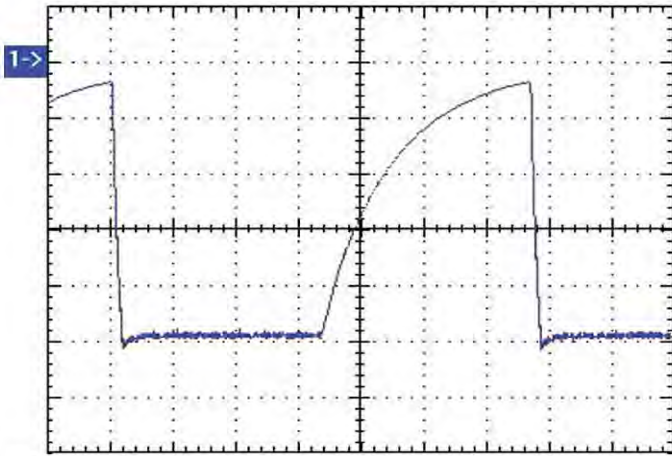

Figure 2. Typical output of the negative pole (-75 kV), with shielded cables. Load resistance = $83.5\text{ M}\Omega$. Pulse repetition rate = 15 Hz . Vertical scale 15 kV/div , with zero indicated by $1\rightarrow$; horizontal scale 10 ms/div .

electrodes, and the larger values relate to ball-soldered joints of components such as diodes, resistors, and capacitors.

The test SG is shown in Figure 3. The polished brass sphere has a 12.5 mm diameter, and the plane is formed by a 20-mm -thick, 63.4-mm -diameter aluminum disc rounded on the edges. Sturdy Lexan stands, reinforced for rigidity, support the electrodes; the gap can be varied between 0 and 40 mm using a threaded rod. Practical test gaps, however, were limited to 15 mm by the voltage capabilities of the HVPS. Field analysis (see Appendix) showed that the field nonuniformity factor f in the practical test gaps varied from unity to slightly greater than 3 . We note here that the electric field inside a sphere-to-plane gap for a symmetrical connection (bipolar voltage application) is very similar to that for a grounded plane.

For testing, we chose a Shell Diala A/AX oil (Shell Oil Company, Houston, TX) widely used in industry. The dielectric



Figure 3. Sphere-to-plane spark gap.

Year	Average BV (kV)	Standard deviation (kV)	Oil condition
2010	34.0	6.1	Fresh
2010	14.6	2.3	Contaminated
2011	40.3	4.0	Fresh

strength at 60 Hz was determined in accordance with ASTM D 1816-84a [11] for fresh oil (before the tests) and for contaminated oil (after the tests). The results are presented in Table 2. Two oil batches, each of approximately 20 L , were used for the three tests listed in the table. One batch was used in 2010 and another in 2011.

C. HV Layout

The SG was immersed in about 20 L of oil contained in a plastic tank (Figure 4). A bleeder load was connected to the HVPS to assist the discharge, and bare silicone rubber HV leads connected the HVPS donuts to the SG. At first, no limiting resistors were used, but after tests with fresh oil (see Fresh Oil section), an assembly consisting of five $22\text{-k}\Omega$ resistors connected in series was mounted on each pole to limit the discharge current. These assemblies were used only with shielded HV cables. In the case of unshielded HV cables, no limiting resistors were needed in view of the small amount of stored energy. With shielded cables, the load was $83.5\text{ M}\Omega$. With unshielded cables, pulsed tests were conducted using a $20\text{-M}\Omega$ load, which allowed testing at PRRs up to 120 Hz .

The polarity was switched by swapping the leads. Thus, all the tests were conducted under a bipolar voltage application (symmetrical connection).

D. Test Procedures

All tests were conducted at room temperature. The voltage was increased linearly at a rate of 4 kV/s until breakdown occurred, or up to a maximum of 150 kV , either by programming the Spellman SL power supply (for measurements with shielded cables), or by programming the HVPS (for measurements with unshielded cables). In the first case, the HVPS operated with an open feedback loop, and in the second case with a closed feedback loop, which yielded tighter regulation of the output voltage amplitude and a flatter pulse top. If breakdown did not occur before the maximum voltage was reached, the voltage was then linearly reduced at 4 kV/s . The tests for each gap spacing were performed for each of the following voltage waveforms:

- 1) positive polarity, marked as DC+ (sphere positive);
- 2) negative polarity, marked as DC- (sphere negative);
- 3) positive polarity pulsed, marked as Pulsed+ (sphere positive);
- 4) negative polarity pulsed, marked as Pulsed- (sphere negative).

TECHNICAL ARTICLES ABOUT HVPS and HV ELECTRONICS

Research Papers

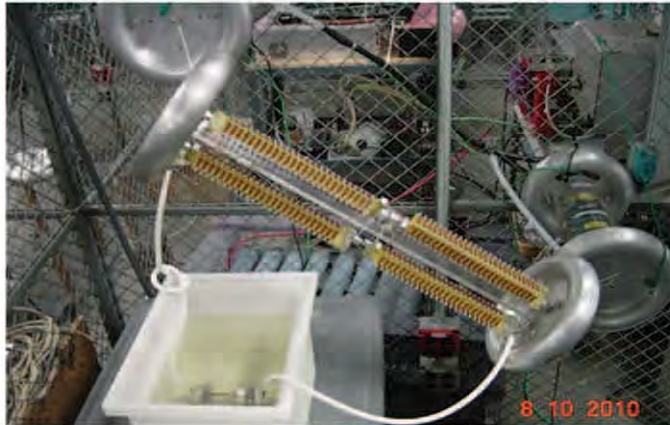

(a)



(b)

Figure 4. HV layout. (a) Shielded HV cables (partially visible). The load is supported by two HV dividers, HVD100 [12], allowing measurement of the voltage between the poles and ground. (b) Unshielded polyethylene cables. A resistive load shortens the voltage impulse fall time.

For waveforms 3 and 4, the ramp voltage modulated the pulsed output. At a PRR of 10 Hz the duty cycle D was 50%, and 20% at PRRs of 30, 50, and 120 Hz.

An interval of at least 1 min was maintained between successive tests, in line with oil testing procedures [11], [13]. Seven breakdown tests were performed for each of the four test types, and the average and standard deviation values were calculated. If the voltage application did not result in breakdown, a BV of 150 kV was assigned to the relevant test. The electrodes were cleaned after each change of gap distance.

The BV in DC tests was determined by a Fluke 179 multimeter (Fluke Corporation, Everett, WA) using its MaxMin function (capturing the maximum value). In pulsed tests, the BV values were recorded by a TDS3034C oscilloscope (Tektronix Inc.). Its horizontal sweep was set in such a way as to capture a few of the last pulses before breakdown. The BV value was taken as the

peak of the feedback divider signal if the breakdown took place on the rising edge or at the crest, or as the amplitude of the “flat” top (disregarding overshoot, if any) if the breakdown occurred at the top or on the trailing edge. The crest value of the envelope of the same signal, on a 10 s/div time base scale, was also recorded. In open-loop operation, the pulse top drooped considerably because of the limited power of the DC power supply; in closed-loop operation, the pulse top was essentially flat.

Test Results

Fresh Oil (Shielded Cables)

The first test series was conducted with fresh oil without limiting resistors at the output of the cables. At a PRR of 10 Hz, breakdowns occurred mainly on the flat top or during the pulse tail. The results are summarized in Figure 5. As expected, BV at negative polarity was higher than at positive polarity. This was the case for gas, liquid, and solid insulation, and for many electrode shapes, gap sizes, and voltage waveforms. A succinct summary of the polarity effect can be found in [5]. There was no clear difference between pulsed and DC breakdown. The BV standard deviation was considerably larger for positive polarity than for negative polarity.

Contaminated Oil (Shielded Cables)

(1) Contamination Attributable to Arcing

After tests with fresh oil, the limiting resistors described in Section IIC were installed on the electrodes as shown in Figure 6 (five 22-k Ω resistors on each pole). At the smallest gap, the arc fault trip did not operate following the first breakdown, so

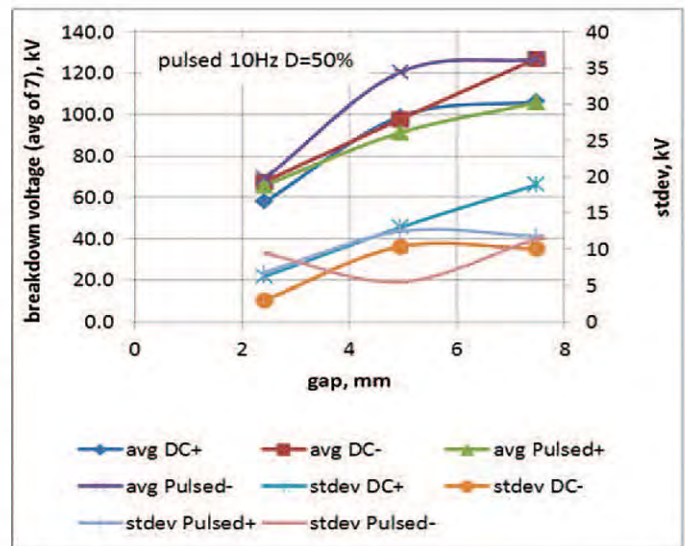

Figure 5. Breakdown voltages for fresh oil, without limiting resistors at the output of the cables. Pulse repetition rate (PRR) = 10Hz, D = duty cycle = 50%.

TECHNICAL ARTICLES ABOUT HVPS and HV ELECTRONICS

Research Papers

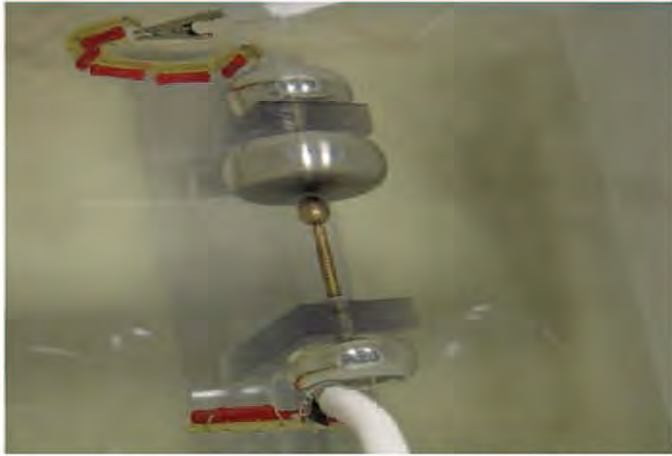

Figure 6. Limiting resistors (in red) attached to the electrodes. Note the soot floating in the oil.

the unit arced many times, sometimes for 1 to 2 s, before shutting down. Because all the charge stored in the cable capacitance passed through the arc channel during every discharge, the oil was blackened with soot despite a low peak current (Figure 6), and its BV, as tested by the standard method, decreased markedly (Table 2).

Two series of tests were performed with the soot-contaminated oil. In the first, the voltage parameters were the same as before, i.e., PRR = 10 Hz and D = 50%. In the second series, PRR = 30 Hz and D = 20% were selected to investigate the influence of the pulse width. A typical set of waveforms at breakdown for the second series is shown in Figure 7. The oscilloscope was triggered on the falling (trailing) edge of the last pulse (pulse on which the breakdown occurred); all breakdowns occurred either

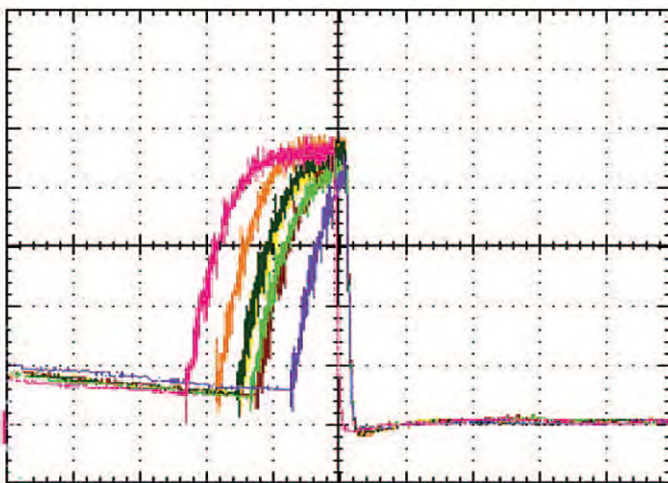

Figure 7. Last pulse at breakdown for a 10-mm gap, negative polarity, oil contaminated by arcing. PRR = 30 Hz, D = 20%. Horizontal scale 2 ms/div, vertical scale 30 kV/div.

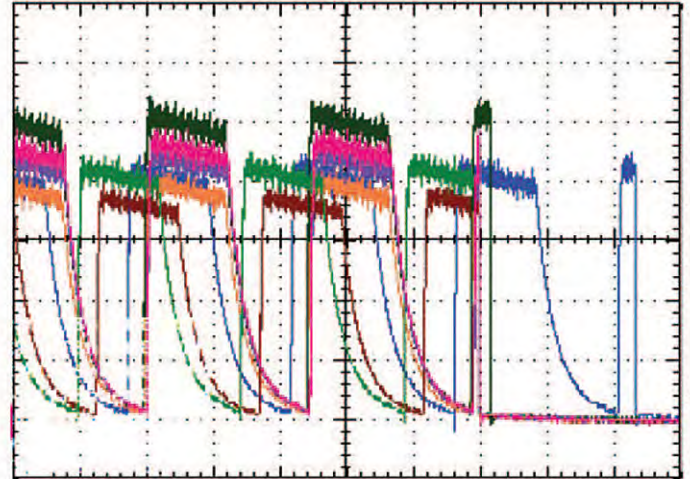

Figure 8. Last pulses before breakdown for a 7.47-mm gap, negative polarity, oil contaminated by arcing. PRR = 10 Hz, D = 50%. Horizontal scale 40 ms/div, vertical scale 30 kV/div.

on the rising (leading) edge or immediately after the crest, but for longer pulses of the first series, they occurred mainly on the “flat” top (Figure 8).

The results are presented graphically in Figures 9 and 10. Again, the BV was higher at negative polarity than at positive polarity (the 15.2-mm gap did not arc in most of the tests up to 160 kV), and the standard deviation was smaller. However, there was a marked difference between pulsed and DC breakdown at both polarities; the average pulsed BV was higher than its DC counterpart by 14.9% for positive polarity, and by 10.3% for negative polarity. We attribute this difference to the bridge breakdown mechanism in contaminated liquids [1]–[2], [4]–[7]. The contaminating particles take some time to form a bridge along the field direction, and initiate breakdown. However, there is no clear difference between long and short pulses (Figure 10).

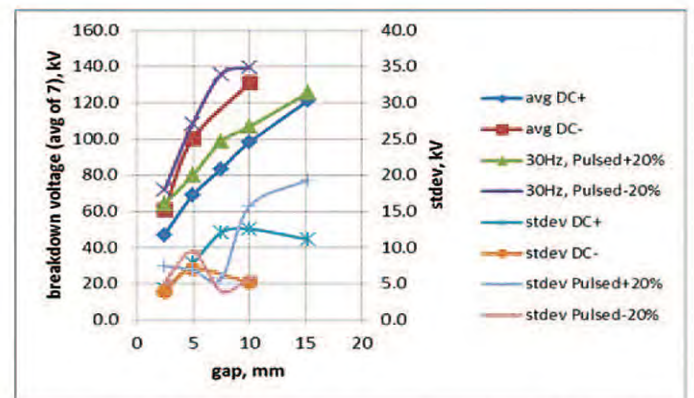

Figure 9. The BV for oil contaminated by arcing. PRR = 30 Hz, D = 20%.

TECHNICAL ARTICLES ABOUT HVPS and HV ELECTRONICS

Research Papers

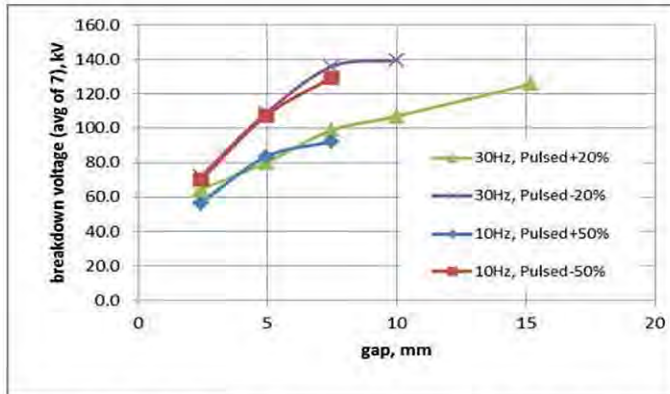

Figure 10. The BV for oil contaminated by arcing. PRR = 30 Hz with $D = 20\%$, and PRR = 10 Hz with $D = 50\%$.

(2) Contamination with Soot and Other Additives

An even greater decrease in dielectric strength might be expected for heavily contaminated (aged) oil, compared with fresh oil and soot-contaminated oil. Because contamination of the oil through conventional commercial usage would be too slow, we opted to add other contaminants with well-defined properties. Two sets of samples were prepared as follows:

- (a) 4 mL (approximately 0.24 g) of fine silica (Degussa R812, hydrophobic, particle size 8 nm, also known as Aerosil R 812, Evonik Degussa GmbH, Essen, Germany) was thoroughly mixed with 20 L of the soot-contaminated oil used in the measurements described above.
- (b) In addition to the fine silica particles, 4 mL of a silicone-based paste containing nano-sized carbon black (Dispersion Technology Inc., Bedford Hills, NY; color K-73169, average particle size 42 nm) was then added and stirred until uniformly dissolved, blackening the oil and rendering it almost opaque.

BV measurements were made only on a 15.2-mm SG at positive polarity because no dramatic change in dielectric strength, compared with that measured on samples contaminated only with soot, was found.

Although silica reduced the BV to some extent, carbon black increased it (Table 3). Possible explanations for the increase are as follows:

- (1) Oil containing conductive or semiconductive nanofillers has greater breakdown strength than oil without nanofillers [14]–[16].
- (2) Field nonuniformity decreases with increasing conductivity.

Contaminated Oil (Unshielded Cables, 2011)

Measurements were made on a new batch of oil that had been contaminated by soot formed during prolonged arcing in preliminary tests. The aim was to investigate whether PRRs above 30 Hz had a greater effect on dielectric strength than those that had been observed up to 30 Hz. Accordingly, the time intervals between successive tests were kept as short as possible; i.e., a positive DC test was followed immediately by a pulsed DC test, or vice versa. The gap width and the arrangement of the leads were not modified, so that the oil was not stirred and its condition remained very largely unchanged between tests. Thus a meaningful comparison between DC and pulsed tests was possible; a comparison of results obtained days apart would be questionable.

Unshielded HV cables, heavier loads, and closed-loop operation allowed testing at higher PRRs with cleaner waveshapes. Figure 11(a) shows, for PRR = 50 Hz, a typical last pulse prior to breakdown, and the following pulse on whose flat top the breakdown took place. Traces 1 and 3 in Figure 11(b) show pulses during which breakdown occurred, at PRR = 120 Hz. The rise times of these pulses are less than 1 ms, whereas trace 2 shows that the trailing edge of a pulse during which breakdown did not occur was approximately 7 ms in duration. Breakdowns were observed only along the leading edge or the flat top, never along the trailing edge.

The test results are summarized in Figure 12. Figure 12(c) is constructed using the breakdown voltages shown in Figures 12(a) and 12(b), omitting standard deviations in the interests of clarity. In Figure 12(c), (50) or (120) indicate that the breakdown voltages at DC were measured in successive tests with their pulsed counterparts at 50 or 120 Hz, respectively. Thus avg DC+(120) means that positive DC breakdown voltages were measured immediately before or after pulsed tests at positive polarity and at 120 Hz (avg Pulsed+120Hz) for each gap width. Thus the oil was not stirred between these tests (as it would be if the gap were changed or the leads swapped).

Clearly, the BVs for the pulsed waveform at both 50 and 120 Hz are considerably higher than their DC counterparts. Figure 12(c) shows that the breakdown field, E_{br} , decreases sharply with increasing field nonuniformity factor f . The latter is calculated for the geometry shown in Figure 14 of the Appendix.

Table 3. Breakdown Voltages for Oil Contaminated With Soot and Other Additives, Measured Using a 15.2-mm Spark Gap.

Test type	Average BV (kV) for oil contaminated with soot and other additives	Average BV (kV) for oil contaminated only with soot
DC+	116 (soot + silica)	121
DC+	127 (soot + silica + carbon black)	121
Pulsed+, 30 Hz, $D = 20\%$	132 (soot + silica)	125.7
Pulsed+, 30 Hz, $D = 20\%$	130 (soot + silica + carbon black)	125.7

TECHNICAL ARTICLES ABOUT HVPS and HV ELECTRONICS

Research Papers

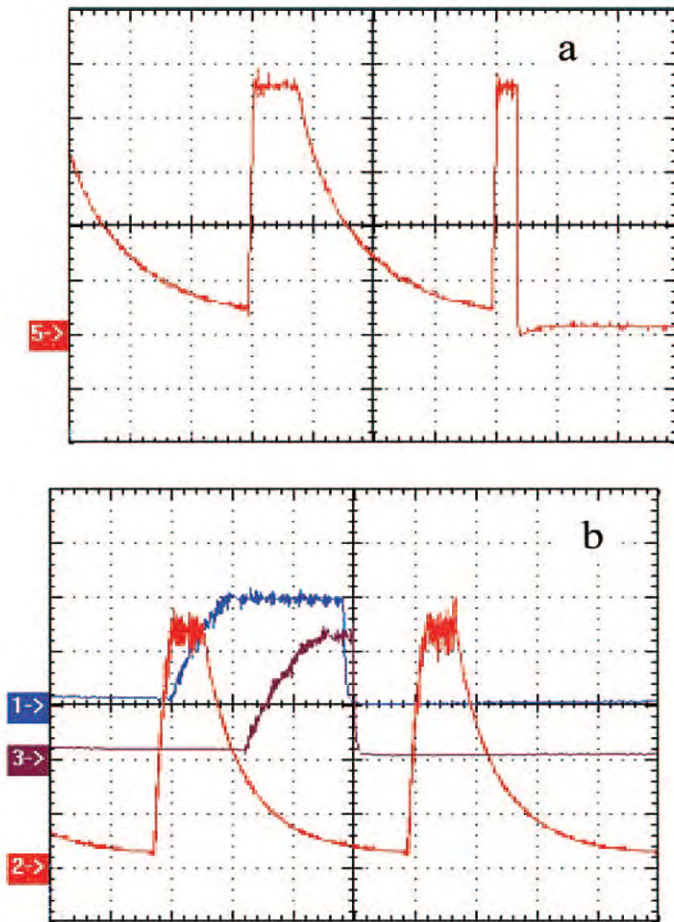
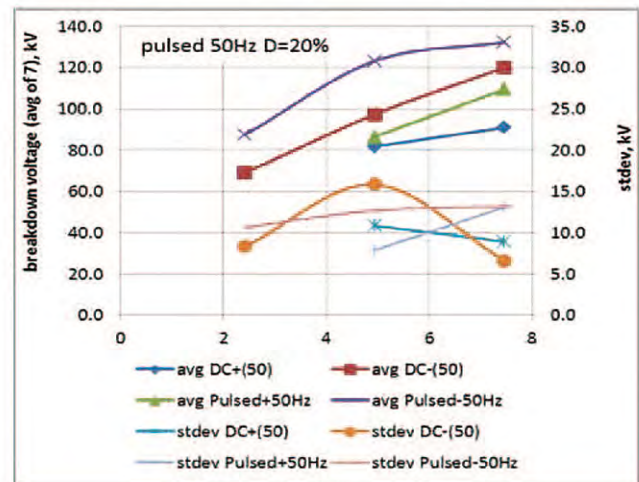

Figure 11. Typical pulse waveforms. (a) The last pulse prior to breakdown, followed by the pulse during which breakdown occurred. Gap = 7.47 mm, load = 82 M Ω , negative polarity, PRR = 50 Hz, horizontal scale = 5 ms/div, vertical scale = 30 kV/div. 5 \rightarrow indicates the zero on the vertical axis. (b) Traces 1 and 3 show pulses on which breakdown occurred, with horizontal scale 0.5 ms/div, vertical scale 60 kV/div. Trace 2 shows the long trailing edge of a pulse when breakdown did not occur, horizontal scale 2 ms/div, vertical scale 30 kV/div. 1 \rightarrow , 2 \rightarrow , and 3 \rightarrow show the zeros on the vertical axis for the corresponding traces. Gap = 4.94 mm, load = 20 M Ω , negative polarity, PRR=120 Hz.

Table 4, in which the results of all the tests are drawn together, shows that the breakdown voltage is consistently higher under pulsed conditions than at DC.

Conclusion

The results presented above suggest that, when designing oil insulation for pulsed conditions at frequencies up to at least 100 Hz, one can afford to decrease the insulation thickness by 10 to 20% relative to those required at DC. However, great care must be exercised because of the small number of tests carried



(a)

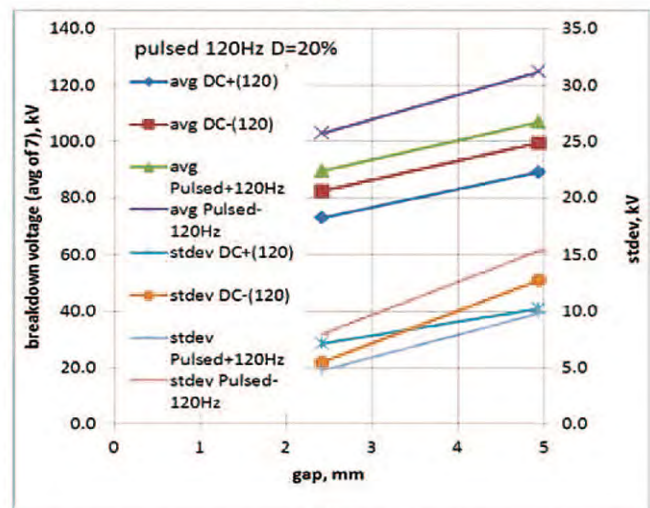

(b)

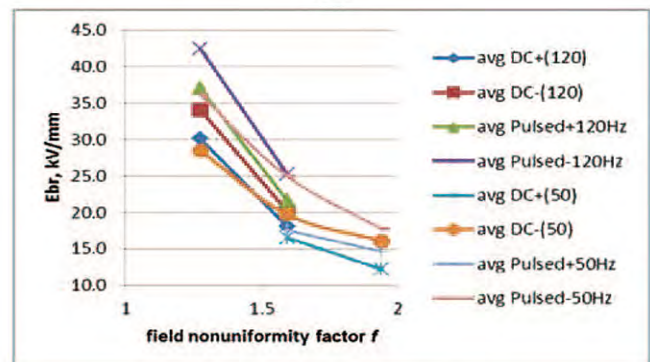

(c)

Figure 12. Test results (2011). (a) DC and pulsed test at PRR = 50 Hz, D = 20%. (b) DC and pulsed test at PRR = 120 Hz, D = 20%. (c) Dependence of the breakdown field E_{br} on field nonuniformity factor f . c is constructed using the data in a and b (note the uniformity of the data series legends in a, b, and c).

TECHNICAL ARTICLES ABOUT
HVPS and HV ELECTRONICS
Research Papers

Table 4. Percentage Increase in Breakdown Voltage (BV) for Pulsed Waveforms Relative to Their DC Counterpart [D = 50% at Pulse Repetition Rate (PRR) = 10 Hz, D = 20% for the Other PRRs].

PRR, Hz	Polarity	
	Positive	Negative
10	15.6	10.4
30	14.9	10.3
50	12.0	16.6
120	19.3	22.2

out over a very limited parameter range. Only solid insoluble impurities were present in the oil under test, and the oil conditions were largely uncontrolled. It should also be recognized that much larger stressed oil volumes in real systems would result in lower breakdown voltages, compared with our test gap results (see Ch. 6 of [5]).

Since only solid impurities were present in the oil, one should consider the bridge mechanism of breakdown. For DC or pulses longer than, say, 50 ms, the particles can form a bridge that may initiate breakdown [1], [2], [4]–[7]. It can be argued that the findings of this work are consistent with this breakdown mechanism. At higher frequencies (30 to 120 Hz) breakdown occurred mainly on the leading edge of the pulse or immediately afterward, whereas at 10 Hz (and longer pulses) it occurred mainly on the flat top or the trailing edge of the pulse. Thus it took several tens of milliseconds to complete breakdown, which strongly suggests that slow processes were involved.

Appendix

In this section, we quantify field nonuniformity in the test gap, and ground influence in the case of symmetrical connection. It is known that even distant ground may cause dramatic changes in the field distribution when least expected (see [17] for an example of a two-wire transmission line suspended high above ground, the distance between the wires being several orders of magnitude smaller than the distance to ground).

An analytical solution for the field on the axis of a sphere-to-sphere gap in symmetrical connection can be obtained in series

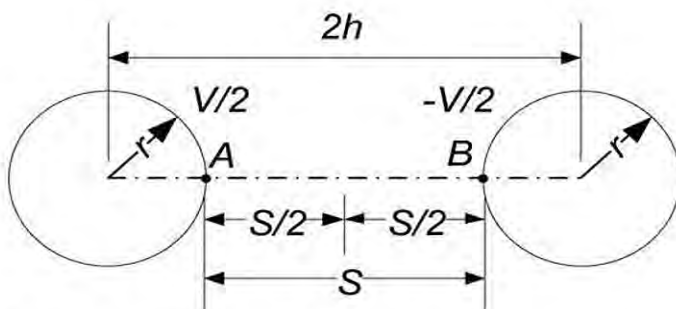

Figure 13. Sphere-to-sphere gap geometry.

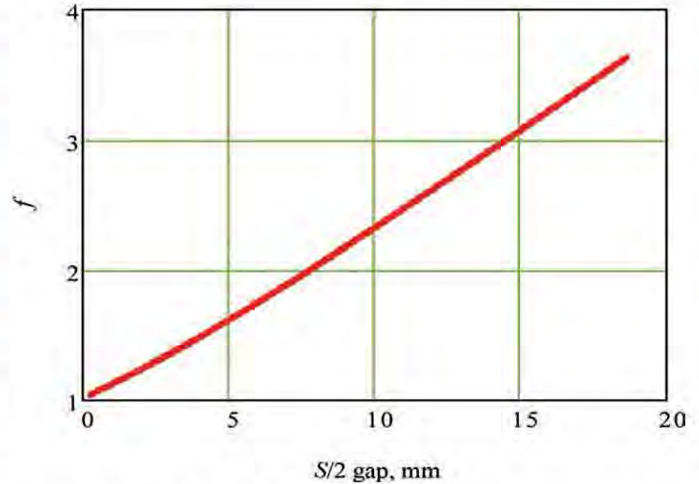

Figure 14. Field nonuniformity factor *f* as a function of the sphere-to-plane gap *S/2*, with $2r = 12.5$ mm (Figure 13). $N =$ number of terms in series (2) = 1000.

form, using the method of images [18]–[20]. The field maximum E_m is found at points A and B on the axis connecting the spheres (Figure 13). For symmetric connection

$$E_m = \frac{V}{2r} \frac{(1+x)^2}{1-x} \cdot \sum_{n=0}^N x^{2n} \cdot \frac{1-x^{2n+1}}{(1+x^{2n+1})^2}, \quad (2)$$

where $x = (h/r) - \sqrt{(h/r)^2 - 1}$ and V is the potential difference between the spheres (one at $V/2$ and the other at $-V/2$ relative to ground). The field nonuniformity factor $f = E_m/E_{av}$, where the average field in the gap $E_{av} = V/S$, and the gap is $S = 2(h - r)$.

Recognizing that the plane perpendicular to the axis and equidistant from the spheres is at zero potential, we can find the maximum field in the sphere-to-plane gap from (2) by halving the applied voltage and halving the gap width (see Figure 13). The field nonuniformity factor for a halved gap $S/2$ is shown in Figure 14 for a range of gap widths.

Finite element analysis was used (Maxwell 2D Student Version [21]) to investigate the influence of the ground position on the field distribution. Using an axisymmetric approximation (R - Z coordinates), we analyzed both symmetrical and asymmetrical connections. Some simulation examples are shown in Figures 15–18. Here, Z is the axis of rotation, and R is the radial coordinate. The positive electrode, a sphere mounted on a rod, is shown in red, and the negative electrode, a disc, is shown in blue (see Figure 3). Note that the case of symmetrical connection with an open boundary (Figure 18, zero voltage at infinity) is closest to the ideal case (Figure 13). It was found that the ground presence influences the field distribution only slightly, as do the HV leads, provided the gap is much smaller than the disk diameter. Thus, f in our tests can be reliably estimated from Figure 14. The discrepancy between analytical solutions obtained using

TECHNICAL ARTICLES ABOUT HVPS and HV ELECTRONICS

Research Papers

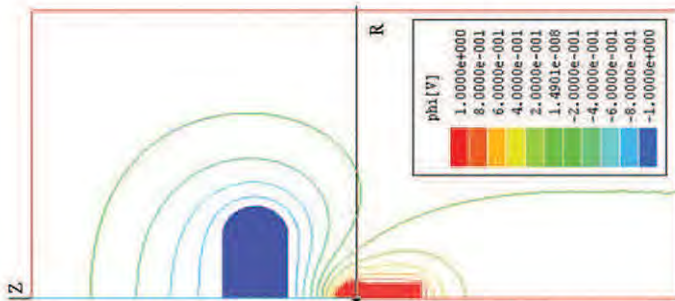

Figure 15. Field distribution with symmetrical connection, grounded boundary shown by red line. The positive electrode (a sphere mounted on a rod), shown in red, is held at potential $\phi = 1$ V. The negative electrode (a disk), shown in blue, is held at $\phi = -1$ V. Gap = 15 mm, field nonuniformity factor $f = 2.8$.

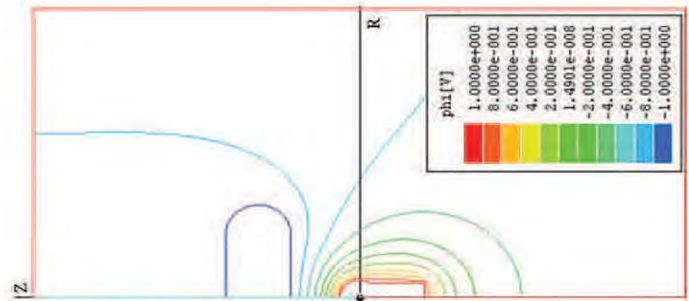

Figure 18. Field distribution with symmetrical connection, boundary open, $f = 3.2$, voltage $\phi = 1$ V applied on the positive electrode (sphere mounted on a rod), voltage $\phi = -1$ V applied on the negative electrode (a disk).

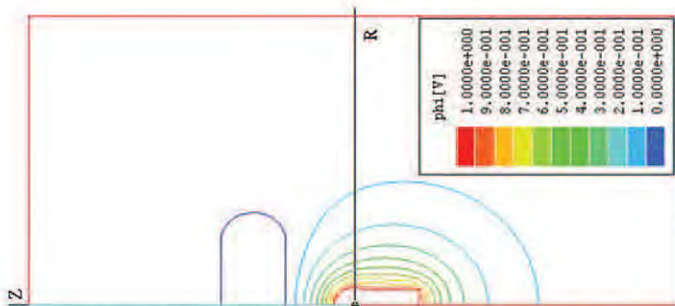

Figure 16. Field distribution with the negative electrode (a disk) and boundary grounded, $f = 3.3$, voltage $\phi = 1$ V applied on the positive electrode (sphere mounted on a rod).

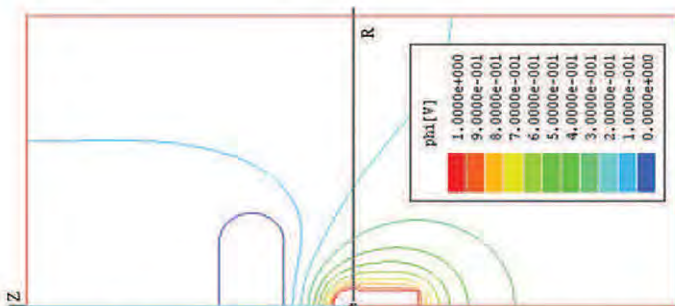

Figure 17. Field distribution with the negative electrode (a disk) grounded, boundary open, $f = 3.15$, voltage $\phi = 1$ V applied on the positive electrode (sphere mounted on a rod).

(1) and (2), and those obtained using finite element analysis for a sphere-to-sphere gap, is typically less than 3% (field plot not shown).

Acknowledgment

The authors thank Spellman High Voltage Electronics Corp. for support of this work.

References

- [1] I. Adamczewski, *Ionization, Conductivity and Breakdown in Dielectric Liquids*, London, UK: Taylor & Francis, 1969.
- [2] T. J. Gallagher, *Simple Dielectric Liquids*, Oxford, UK: Clarendon Press, 1975.
- [3] T. J. Lewis, "Basic Electrical Processes in Dielectric Liquids," *IEEE Trans. Dielectr. Electr. Ins.*, vol. 1, no. 4, pp. 630–643, 1994.
- [4] G. I. Skanavi, *Physics of Dielectrics: Strong-Field Region*, Moscow, Russia: Fizmatlit, 1958.
- [5] V. Y. Ushakov, *Insulation of High-Voltage Equipment (Power Systems)*, Berlin, Germany: Springer, 2004. (Translation from Russian edition, 1994).
- [6] R. A. Lipshtein, and M. I. Shakhnovish, *Transformer Oil*, 3rd ed., Moscow, Russia: Energoatomizdat, 1983. (English translation of *Transformer Oil*, 2nd ed., Jerusalem, Israel: Israel Program for Scientific Translations, 1970).
- [7] V. Ya Ushakov, V. F. Klimkin, and S. M. Korobeynikov, *Impulse Breakdown of Liquids*, Berlin, Germany: Springer, 2007.
- [8] Power supply & x-ray tube in an integrated subsystem [Online]. Available: http://www.spellmanhv.com/~media/Files/Downloads/Monoblock_catalog_ashx
- [9] P. L. Bellaschi and W. L. Teague, "Dielectric Strength of Transformer Insulation," *Electr. Eng.*, vol. 56, no. 1, pp. 164–171, Jan. 1937.
- [10] SL Series of high voltage power supplies [Online]. Available: http://www.spellmanhv.com/~media/Files/Products/SL_ashx
- [11] *Test Method for Dielectric Breakdown Voltage of Insulating Oils of Petroleum Origin Using VDE Electrodes*, ASTM D 1816-84a, 1990.
- [12] http://www.spellmanhv.com/~media/Files/Products/HVD_ashx
- [13] *Insulating Liquids—Determination of the Breakdown Voltage at Power Frequency*, 2nd ed., IEC 156, 1995.
- [14] *Insulation Liquid*, by O. Hjortstam, T. Auletta, A. Jaksts, R. Liu, L. A. A. Pettersson, and L. Walfridsson (2008, Jun. 19), WIPO Patent Application WO/2008/071704.
- [15] J. G. Hwang, M. Zahn, F. M. O'Sullivan, L. A. A. Pettersson, O. Hjortstam, and R. Liu, "Electron scavenging by conductive nanoparticles in oil insulated power transformers," presented at 2009 Joint Electrostatics Conference, Boston, MA, Jun. 2009.

TECHNICAL ARTICLES ABOUT HVPS and HV ELECTRONICS

Research Papers

- [16] J. G. Hwang, "Elucidating the Mechanisms Behind Pre-breakdown Phenomena in Transformer Oil Systems," PhD Thesis, MIT, Cambridge, MA, 2010.
- [17] Pokryvailo, A., Yankelevich, Y., Nissim, N., Baksht, R., and Ashkenazy, J., "Development of Short Pulsed Corona on Two-Wire Transmission Line," *IEEE Trans. Plasma Sci.*, vol. 34, no. 1, pp. 104-114, Feb. 2006.
- [18] G. I. Skanavi, *Physics of Dielectrics: Strong-Field Region*, Moscow, Russia: Fizmatlit, 1958.
- [19] K. A. Rezvykh, "Calculation of electrostatic fields," *Energia*, vol. 34, no. 1, pp. 73-75, 1967.
- [20] E. Kuffel and W. S. Zaengl, *High Voltage Engineering*, 2nd ed. Oxford, UK: Pergamon Press, 1984/2000.
- [21] Maxwell 2D Student Version, Ansoft Corp., Pittsburgh, PA, 2002.



Alex Pokryvailo was born in Vyborg, Russia. He received the M.Sc. and Ph.D. degrees in electrical engineering from the Leningrad Polytechnic Institute in 1975 and 1987, respectively. Formerly with Soreq Nuclear Research Center, Israel, he is now with Spellman High Voltage Electronics Corporation, serving as Director of

Research. His recent experience relates to design of HV high-power switch-mode power supplies, pulsed power with empha-



Costel Carp (IEEE Member since 2006) was born in Romania. He earned his B.Tek degree from Polytechnic Institute, Iasi, Romania, in 1986, and has been with Spellman High Voltage Electronics Corporation since 2002. His main field of expertise is power electronics, with emphasis on high-voltage, high-power supplies for industrial and medical applications.



Behavior of HV Cable of Power Supply at Short Circuit and Related Phenomena IEEE Transactions on Dielectrics and Electrical Insulation

Alex Pokryvailo, Costel Carp and Cliff Scapellati
Spellman High Voltage Electronics Corporation

ABSTRACT

Discharges in many HV loads are unavoidable at voltages close to their operational limits. Such loads may be vacuum gaps, e.g., X-ray tubes. The discharge characteristics depend not only on the state of the load, but, in the case of a vacuum gap, on external circuitry. In cabled connections, the cable length is critical. Long cables may decrease the breakdown voltage, which is mostly overlooked in literature. Selected experimental data and means of improving performance are reviewed. Regarding methods of cable connections, we consider two cases. In the first, regular connection, the cable shield is connected to ground on both sides. Then the processes in the cable can be described by conventional transmission line equations. Pattern of traveling waves developing at short-circuit conditions and overvoltages (OV) at the power supply side are shown as a function of the cable parameters. In the second case, the shield at the power supply side is grounded, and at the load side it is floating (unterminated shield connection). It is shown that conventional two-wire transmission line model is no longer applicable. PSpice equivalent circuits with lumped parameters are developed and analyzed. It is shown that the cable insulation is overstressed at the load side in unterminated shield connections, and at the power supply side in regular connections. Experimental results obtained on low-voltage models are presented.

Index Terms - High-voltage cable, insulation, short-circuit, overvoltages, X-ray tube.

1 INTRODUCTION

1.1 GENERAL

DISCHARGES in HV loads at voltages close to their operational limits are virtually unavoidable. Such loads may include devices operating in vacuum, and in particular, X-ray tubes. The discharge characteristics depend not only on the load, but, to a large extent, on the external circuitry, namely, the capacitance directly connected to the load, and limiting impedance, if any. The influence of external circuit is most strongly expressed in the case of vacuum loads and is much less felt in atmospheric pressure gas loads.

Often the load is connected to the high voltage power supply (HVPS) via a long HV cable. The cable can have its shield a) grounded on both sides or b) only at the HVPS side. We will term the latter as “unterminated shield connection”. For the clarity sake, we note that only coaxial cables are considered in this paper. In this category also

fall the cables with several central conductors that can be used for filament and grid supplies. In the case a) the processes in the cable can be described by conventional transmission line equations (see, e.g., [1], [2]). It will be shown that in unterminated shield connections, these equations are inapplicable “as is”. We are unaware of analyses of such connections in literature.

1.2 VACUUM LOAD

As noted above, we single out vacuum gaps because their discharge characteristics are most sensitive to the feeding scheme. The authors are well familiar with X-ray tubes and their HVPS; this why we focus further on these devices.

Although the theory of discharge in vacuum is far from being complete [3]-[8], from the angle of electromagnetic interference (EMI) we will distinguish between a) microdischarges and b) spark discharges. (Here, we follow mostly the terminology of [3], [8].) The first are characterized by minor voltage drops, whereas spark fully discharges the capacitances connected to the load. We will term the sum of these capacitances as “output capacitance”, C_{out} . Spark may transit to arc if HVPS does

TECHNICAL ARTICLES ABOUT HVPS and HV ELECTRONICS

Research Papers

not limit the current below a certain level or does not shut down.

Microdischarges may be weak (milliamperes) and as such do not create serious disturbance. However, more intense microdischarges are also common [3] (see also [8] p. 24). The load voltage does not collapse fully, but the spurious discharge currents are much stronger, exceeding ampere levels, and may lead to malfunctioning of sensitive electronics [9]. Microdischarges in X-ray tubes are often related to presence of residual gas.

Sparks are associated with short μs current pulses that may be many kA in amplitude. The time of the current rise depends on the velocity of the plasma front bridging the gap. There is a consensus now based on a large body of experimental work that this velocity is typically 2 cm/ μs for cm-long gaps. Thus, the “closure” time of a vacuum gap can be estimated from the above considerations with high confidence; the current risetime is, obviously, shorter, depending also on capacitance C_{out} directly connected to the electrodes. The current amplitude I_m increases with C_{out} and, by one of the popular theories, is approximately proportional to C_{out}^2 starting from a certain value of C_{out} : $I_m \sim C_{out}^2$ [10].

We note that in liquid and solid dielectrics breakdown develops much faster than in vacuum. This is also true for gases at relatively high pressure. For instance, in air at atmospheric pressure and higher, moderate-length gaps are bridged much faster because of high speed of streamer propagation (of the order of 10^7 - 10^8 cm/s at atmospheric pressure, depending on gap and voltage parameters; see, for example, [11], [12] and their bibliography) and faster spark development.

Yet another important feature of spark breakdown in vacuum is the decrease of the breakdown voltage, V_{br} , with the increase of C_{out} . In X-ray apparatus, V_{br} drops dramatically when a long HV cable is used. We observed, for instance, that with a 15-m cable with rubber insulation V_{br} dropped from 70 kV to below 55 kV for a tube rated at 70 kV. With other tubes, V_{br} was 25-35 kV and 45-50 kV with 9-m and 3-m cable, respectively [9].

A convincing proof of the influence of the external circuitry on the breakdown voltage of a vacuum gap was given in [3] (see also [13]). It was found that even a small resistance separating C_{out} from the gap increases V_{br} by tens of percent. Likewise, reduction of stored energy also acted favorably on the dielectric withstand of *conditioned* gaps. Our experimental work is in line with these findings (see Section 4).

1.3 INFLUENCE OF HV CABLE LENGTH ON ELECTROMAGNETIC PROCESSES

When accounting for the HV cable influence on electromagnetic processes, a simplest approximation would be representing the cable by a lump capacitance. This simplification works quite well for almost all scenarios except short transient phenomena, the reason for the latter being that the cable electrical length may be commensurable with the time of the gap flashover. In this

case, it is more correct to represent the cable as a transmission line with characteristic impedance Z and speed of propagation v (losses can be neglected unless the cable is very long). Speed of propagation is $v = c/\sqrt{\epsilon}$, where ϵ is relative permittivity of the cable insulation, on condition that the cable does not contain ferromagnetic materials; c is speed of light. In this section, we adopt the values $Z=59 \Omega$, and $\epsilon=3.15$. The first is taken from the specifications of a 2042 Dielectric Sciences cable [14], and the second is a value calculated from the cable capacitance and geometry, again for the same cable. Thus, the time it takes for the wave to travel 1m in a 2042 cable is $\tau=5.3$ ns.

With a short cable, all transients may decay before the gap has been bridged by plasma, and the discharge may not transit to a spark. With longer cables, there is more time for the plasma propagation at conditions of sustainment by the cable energy. Let us analyze an example. For a 2-cm gap, typical for some X-ray tubes rated at 150 kV, the time that takes to plasma to fully bridge the gap is $\sim 1 \mu\text{s}$, and it is considerably smaller for gas gaps at atmospheric and higher pressure. The current risetime is considerably shorter [3], [6]-[8]. A 3-m cable is able to sustain the discharge for only about $3\tau \approx 16$ ns, whereas a 15-m long cable makes it 79 ns. We note that a 3-m cable can be “short” for a vacuum load, but be quite “long” for a high-pressure gas-discharge load. These arguments, even though oversimplified, indicate to a critical importance of the cable length.

We note that the cable limits the discharge current to a value of $I_m = V/Z$, where V is the charge voltage.

The mere presence of long HV cables has tremendous influence on dielectric behavior of HV loads, especially, vacuum gaps, and OV in HVPS resulting from load breakdown. The nature and magnitude of OV depend on the method of the cable connection. These factors, mostly overlooked in literature, are addressed in the following sections (see also [15]).

2 BASIC ANALYSIS OF TRANSIENT PHENOMENA WITH SHIELD GROUNDED ON BOTH ENDS (REGULAR CONNECTION)

In many HV systems the cable shield is grounded on both ends. Then, if the load is short-circuited, the cable discharges in such a way that both the voltage and current are reflected from both ends with polarity reversal. The process repeats itself until all the energy dissipates, mainly as heat. This case has an analytical solution that can be found elsewhere [16], [17]. We use PSpice simulations. Multiple reflections are illustrated by the waveforms of Figure 1. Here we assume that the charging power supply V_1 is isolated from the cable, which is typical of HVPS having arc-limiting means. Notably, the voltage at the cable start contains a high-frequency component detrimental for insulation.

TECHNICAL ARTICLES ABOUT HVPS and HV ELECTRONICS

Research Papers

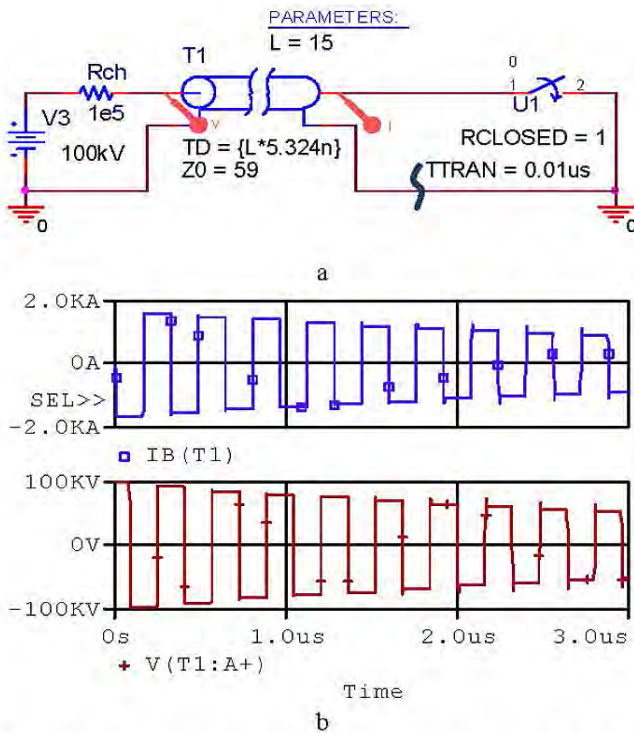

Figure 1. a - PSpice model of 15-m 2042 cable discharge on short circuit. Switch closing/transition time, TTRAN, is a PSpice parameter; it is much shorter than cable electrical length. **b** - timing diagrams. Current amplitude is V/Z.

If the line is shorter, and/or the transition time is larger, the reflections are less intense. They disappear below some critical length, in this case below 3m. Figure 2 shows the dependence of the peak reversal voltage and peak discharge current on the cable length (referenced to charge voltage of 100 kV). It is seen that both the peak reversal voltage and peak discharge current tend to their theoretical limits at larger lengths.

3 TRANSIENT PHENOMENA AT UNTERMINATED SHIELD CONNECTION

3.1 THEORETICAL

The cable shield is not grounded at the load side in many applications, e.g., electrostatic precipitation and ion implantation, and in HV testing and general laboratory practice. It appears that notwithstanding the practical importance of this case, no analyses are available in open literature.

A basic assumption in deriving telegraphic equations for a two-conductor transmission line is that both conductors carry only differential currents that are equal to each other in every point [1], [2], [16]. Incidentally, the PSpice TL models presuppose that this is the case, hence trying to insert an impedance between the shield and ground on one end yields absurd results. However, unterminated shield connection presents exactly such a situation! If the shield is lifted off ground as shown by the curved line in Figure 1, shield current

is not. Actually, in unterminated shield connection we deal with a three-conductor transmission line, the third conductor being ground. On the next level of complexity, we note that such a line may not support TEM modes if the cable is far from ground, which means that the cross-sectional distances are commensurable with wavelength. In this case, the shield may act as an antenna. However, neglecting displacement currents flowing from the shield to ground and between adjacent parts of the shield itself (in the instance of a coiled cable), we can stay within a convenient simplicity of a two-wire line approximation. It will be seen that such a simplification still allows analyzing salient phenomena of the load breakdown in unterminated shield connection.

We will use lumped circuit modeling, one of the reasons being that it allows PSpice modeling. First, we take a look at traditional equivalent circuit used for deriving telegraph equations Figure 3. Such circuits (PFNs) are also used for generation of rectangular pulses. Note that the return conductor is just a wire; all impedances are lumped into the forward conductor, and thus, the currents in both are equal. We cannot use such a model to have zero current through the isolated shield at distal end at short circuit. Rather, we halve the inductance between the forward and return conductors, so that the total cell inductance remains the same. Figure 4a shows such a model for a 10-m RG-58/U cable (neglecting losses), whereas Figure 4b is the same in conventional representation.

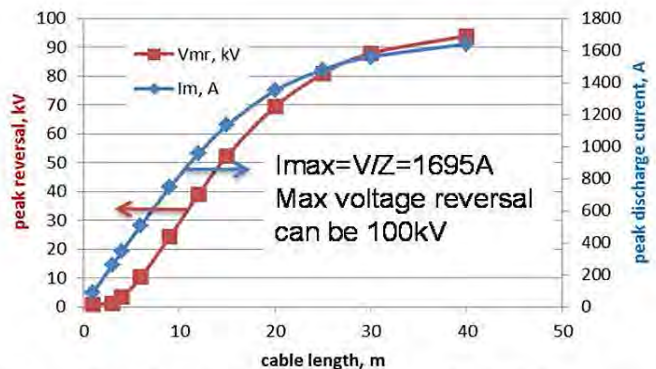

Figure 2. Dependence of peak reversal voltage (V(T1:A+)) and peak discharge current (IB(T1)), respectively, per notation of Figure 1) on cable length (referenced to charge voltage of 100 kV). In these simulations, TTRAN=1 μs (actual transition from 90% to 10% is 200ns).

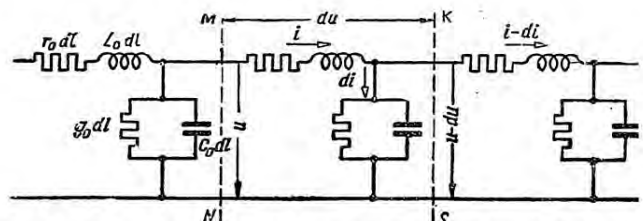

Figure 3. Lumped representation of two-wire TL (copied from [16]). L_0 , C_0 , r_0 and G_0 are TL inductance, capacitance, resistance and conductance, respectively, per unit length.

TECHNICAL ARTICLES ABOUT HVPS and HV ELECTRONICS

Research Papers

Figure 5 shows simulation results for the circuits Figure 4a, b for $R_6=10^9 \Omega$, i.e., shield grounded at distal end. Circuit Figure 4b generates usual quasi-rectangular waveforms (compare to their experimental counterparts below) as any PFN would. However, circuit Figure 4a, differing only in that the cell inductance is just split in two, defying common sense, generates triangular rather than rectangular waveforms.

Figure 6 is a simulation of circuit Figure 4a for $R_6=10^9 \Omega$ (unterminated shield connection). It is seen that the shield voltage at distal end jumps to the supply voltage upon the switch closure and then starts oscillating. Thus, in an unterminated shield connection, the insulation on both sides of the cable is subjected to full voltage reversals. This puts large stress on the cable terminations [18].

3.2 EXPERIMENTAL

A low-voltage test rig schematic diagram is shown in Figure 7. Two sections of ~ 5.5 -m-long RG-58 cables (total length ~ 11 m, electrical length ~ 58 ns) joined with a BNC Tee were charged up to 60 V through a high-value limiting resistor. The cable was coiled and put on an aluminum plate that was connected to system ground. The TL was discharged in a repetitive mode to ground using a fast MOSFET IRFD110 (actual switching time with hard gating - no gate resistor - was < 5 ns—see Figure 8). TL voltages were monitored by a DPO7054 scope with 400 MHz P6139A probes in three points: at TL start $V(0)$, at half-length $V(d/2)$, and distal end $V(d)$.

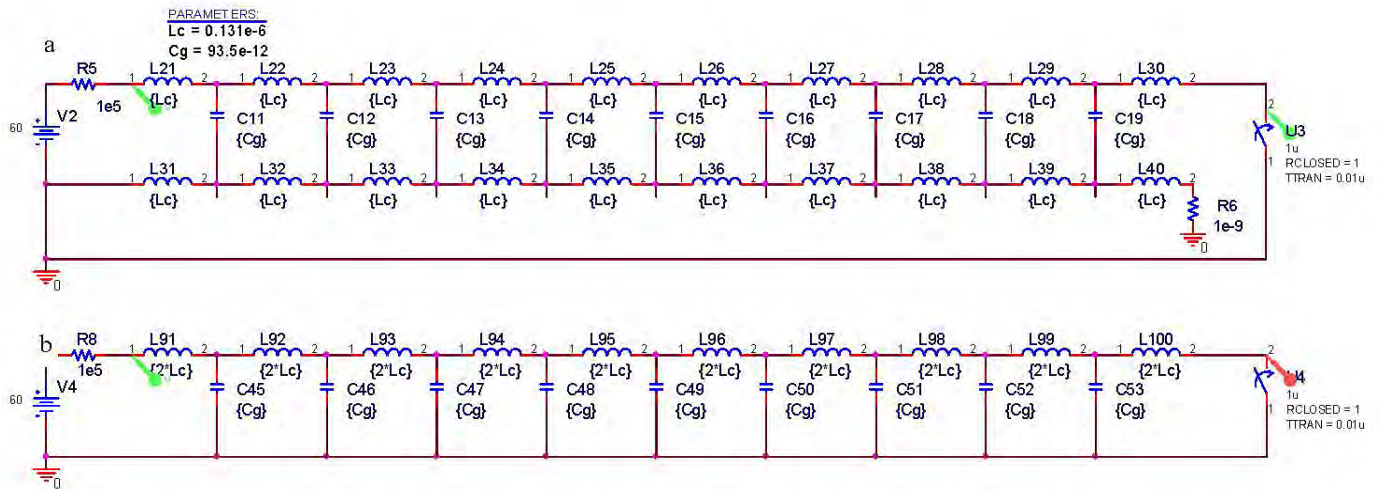

Figure 4. Lumped PSpice model of a 10-m RG-58/U cable. a – shield isolated at distal end. Cell inductance is split in two; b – conventional model lossless transmission line model. RG-58/U parameters taken from Belden catalog [19]: $L=262 \mu\text{H/m}$, $C=93.5 \text{ pF/m}$.

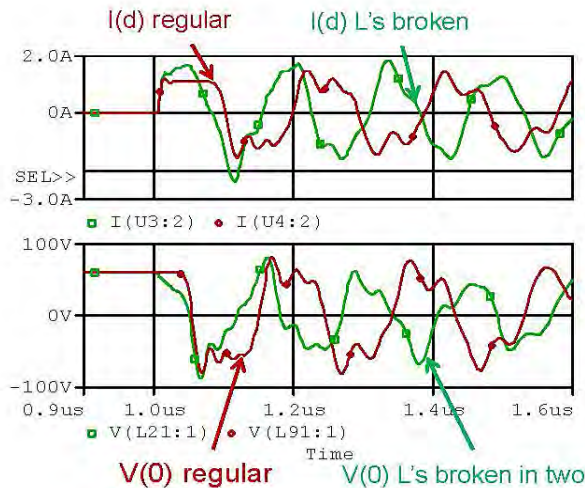

Figure 5. Simulation of circuit Figure 4. $R_6=10^9 \Omega$ (shield at distal end grounded).

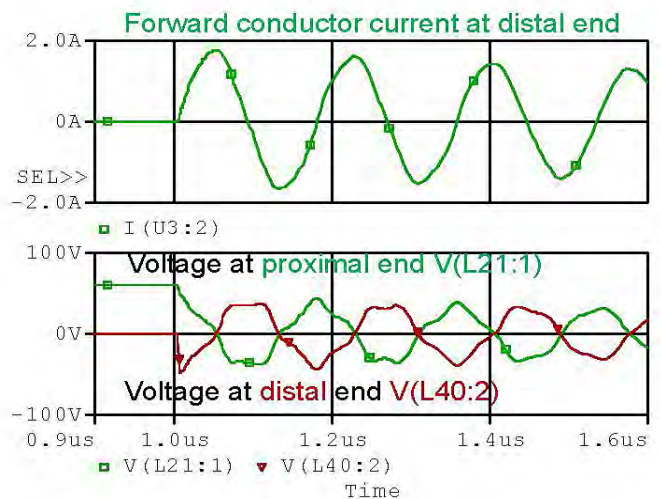

Figure 6. Simulation of circuit Figure 4a. $R_6=10^9 \Omega$ (shield at distal end isolated).

TECHNICAL ARTICLES ABOUT
 HVPS and HV ELECTRONICS

Research Papers

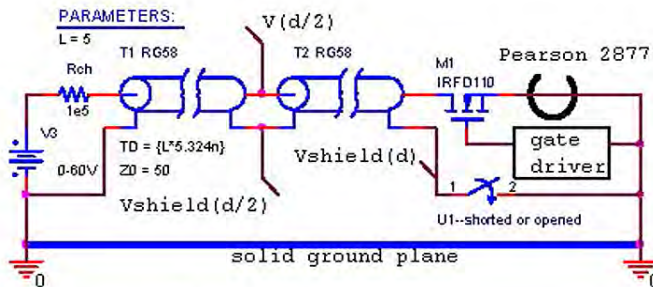

Figure 7. Experimentation scheme.

The shield potential at these points is denoted as $V_{shield}(0)$, $V_{shield}(d/2)$ and $V_{shield}(d)$, respectively. In addition, the current at the distal and/or proximal end was monitored with Pearson 2877 and 2878 current transformers (risetime 2 ns and 4 ns, respectively). Note that coiling the cable and placing it on a grounded plane introduces considerable capacitance of the cable shield to both ground and between the adjacent parts of the shield itself.

A reference experiment was shorting the line with shield connected to ground at distal end. Figure 9 exhibits the waveforms, with expected quasi-rectangular pulses and almost full reversal of voltage and current at proximal and distal ends, respectively.

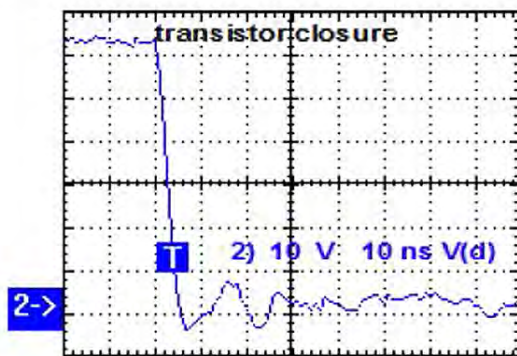

Figure 8. Transistor closure. Waveform annotation here and further gives scales' information (vertical - 10 V/div, horizontal - 10 ns/div) and legend.

With shield isolated from ground at the distal end, the picture is entirely different. Since the shield electric charge cannot disappear instantly, full line voltage is generated between shield and ground at distal end. Traveling waves with full voltage reversal decay slowly at this end. Thus, the cable insulation in unterminated shield connections is subjected to a detrimental stress if load sparks. As shown in [18], the insulation at the shield termination is highly vulnerable, and certainly suffers from high-frequency voltage components. The shield can also spark to ground inducing intense EMI aggravated by the fact that the current discharge loop tends to be large. The radiated field may have detrimental results at the system level. Detailed analysis of such effects is beyond the scope of this paper.

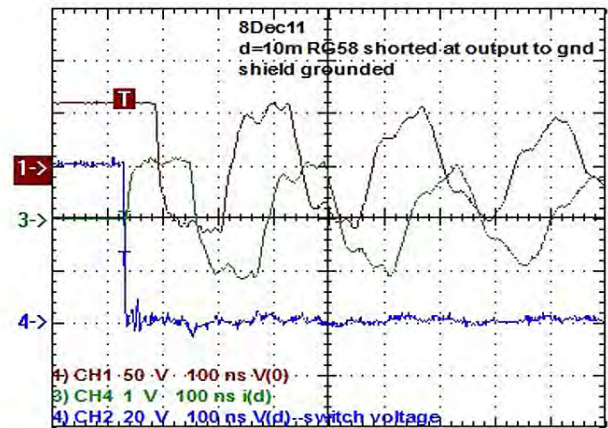

Figure 9. Short to ground, shield shorted at both proximal and distal ends. Trace 1 (Ch1) - voltage at proximal end; Trace 3 (Ch4) - current at distal end 1 A/div; Trace 4 (Ch2) - voltage at distal end (switch voltage). Horizontal - 100 ns/div.

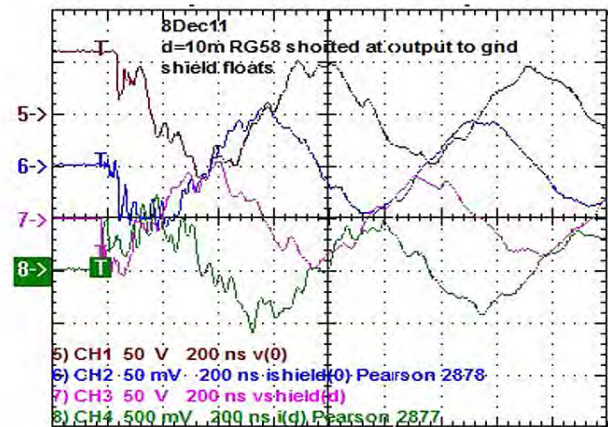

Figure 10. Short to ground, shield floats at distal end. Trace 5 (Ch1) - voltage at proximal end; Trace 6 (Ch2) - current at distal end 0.5 A/div; Trace 7 (Ch3) - shield voltage at distal end; Trace 8 (Ch4) - current at distal end 0.5 A/div; Horizontal - 200 ns/div.

4 MEANS OF INCREASING THE BREAKDOWN VOLTAGE

Usually, HVPS have arc limiters installed at the output *before* the HV cable. They limit the current generated by discharge of the energy stored in the output stages of the HVPS to a level safe both to the load and HVPS itself. In the simplest case, arc limiter is an HV surge resistor. More sophisticated limiters comprised of inductors, resistors, etc., are also used, especially, in high-current HVPS. However, conventional limiters do not prevent energy flow from the cable, which decreases V_b as noted in previous sections. An obvious solution to this problem would be installation of a current-limiting device between the cable and the load. Technical difficulties here are of two kinds. First, space is extremely limited. Second, in X-Ray apparatus, the filament is usually fed by high-frequency current, and the limiter must pass the filament current without generating prohibitively high voltage drop and power losses.

TECHNICAL ARTICLES ABOUT HVPS and HV ELECTRONICS

Research Papers

A means of increasing the breakdown voltage of an X-ray tube fed by an HVPS via a long cable is shown in Figure 11. The limiter electrical and mechanical design, implementation and testing were described in [9], [20]; see also [21] for yet another circuit design. In one of the X-Ray generators, a 35-mm-diameter, 40-mm-long two-winding choke had an inductance of $L_{ch}=200\mu\text{H}$ (measured on one winding). It presented a very low impedance to the filament current but high impedance to discharge current. Assuming that the characteristic frequency of the latter is $f=1\text{ MHz}$, which corresponds to risetime of fractions of a microsecond, we calculate $Z=2\pi fL_{ch}=1.256\text{ k}\Omega$. (Similar and even lower value resistances were very effective in suppressing breakdown in vacuum [3].) The choke was installed in the tube shield between the cable bushing and the tube. It virtually abolished the tube *microdischarges* that otherwise severely destabilized operation. Indirectly, the effectiveness of current limitation was judged by measuring electromagnetic pickup with a $\sim 500\text{ cm}^2$ loop antenna placed in the vicinity of the HV cable. Without the choke, typical pickup signal was 10 V, and with the choke the amplitude dropped by two orders of magnitude, and the frequency of the events was also orders of magnitude lower.

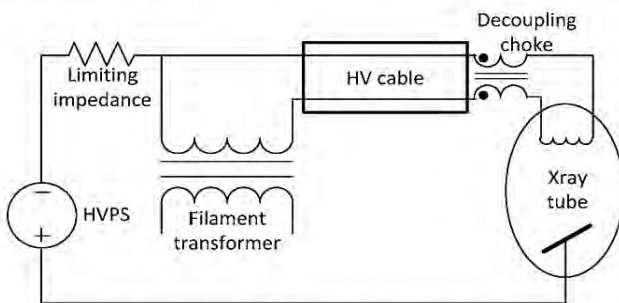

Figure 11. Common-mode choke as an arc-limiter in X-Ray HVPS.

5 CONCLUSIONS

1. The designer should be aware of problems caused by long HV cables. These problems are low breakdown voltage, high insulation stresses and high EMI. Whereas the latter is more evident (more energy is stored, the higher are the discharge currents), the first two factors are commonly disregarded.
2. In regular connection making use of long HV cables, insulation is overstressed by rapid voltage reversals at the HVPS side.
3. In unterminated shield connection, phenomena at short-circuit are not readily described by telegraph equations; cable insulation is overstressed by rapid voltage reversals at the load side. In this case, if long cable is used, its termination should be designed more carefully compared to regular connection.
4. The load breakdown voltage can be considerably increased by inserting a low-value impedance between the cable and the load. For high-current loads, small-value inductors (tens - hundreds μH) are quite effective.

REFERENCES

- [1] G. Miano and A. Maffucci, *Transmission Lines and Lumped Circuits*, Academic Press, NY, 2001.
- [2] C. R. Paul, *Analysis of Multiconductor Transmission Lines*, Wiley, NY, USA, 2008.
- [3] I.N. Slivkov, *Electrical Breakdown of Vacuum*, Energoatomizdat, Moscow, Russia, 1972 (In Russian).
- [4] J.M. Lafferty, Ed., *Vacuum Arcs*, Wiley, 1980.
- [5] R.L. Boxman, D. M. Sanders and P. J. Martin, Editors, *Handbook of Vacuum Arc Science and Technology*, Noyes Publications, NJ, USA, 1995.
- [6] G.A. Mesyats, "Ectons". In three parts, Nauka, Ekaterinburg, 1993 (in Russian).
- [7] G.A. Mesyats and D.I. Proskurovski, *Pulsed Electrical Discharge in Vacuum*, Springer-Verlag, 1989.
- [8] R. Latham, *High Voltage Vacuum Insulation*, Academic Press, San Diego, USA, 1995.
- [9] A. Pokryvailo, K.K. Vlasov, Yu. A. Magdin and A.N. Starchikov, "On the Electromagnetic Compatibility of High Voltage Power Supplies for X-Ray Analytical Apparatus Operating under Conditions of High Voltage Discharges", *Instrumentation and Methods of X-Ray Analysis*, Vol. 40, pp. 151-158, 1990.
- [10] P.T.G. Flynn, "The Discharge Mechanism in a Cold Cathode Pulsed X-Ray Tube", *Proc. Phys. Soc. B (UK)*, Vol. 69, pp. 748-762, 1956.
- [11] E.M. Bazelyan and Yu.P. Raizer, *Spark Discharge*, CRC Press, NY, USA, 294 pp, 1998.
- [12] Yu. Raizer, *Gas Discharge Physics*, Springer, Berlin, Germany, 1991.
- [13] R. Hackam, "Effects of voltage polarity, electric current, external resistance, number of sparkings, supply frequency, and addition of hydrogen and air on electrical breakdown in vacuum", *J. Appl. Phys.*, Vol. 46, pp. 3789-3799, 1975.
- [14] <http://dielectricssciencesthomasnet.com/Asset/2042.pdf>
- [15] A. Pokryvailo, and C. Scapellati, "Behavior of HV Cable at Short Circuit and Related Phenomena", *IEEE Int'l. Power Modulator and High Voltage Conf. (IPMHVC)*, San Diego, USA, Paper 307, 2012.
- [16] K. A. Krug, *Foundations of Electrotechnics*, 6th ed., Vols. 1 and 2, Gosenergoizdat, Moscow, Russia, 1946.
- [17] G. A. Mesyats "Pulsed Power and Electronics", Moscow, Nauka, 2004 (in Russian). Translation to English: *Pulsed Power*, Kluwer, NY, 2005.
- [18] A. Pokryvailo, C. Carp and C. Scapellati, "Comparative Testing of Simple Terminations of High Voltage Cables", *IEEE Electr. Insul. Mag.*, Vol. 26, No. 1, pp. 7-17, 2010.
- [19] RG 58/U cable <https://edeskv2.belden.com/Products/index.cfm?event=showproductdetail&partid=1979>
- [20] A. Pokryvailo, and V. Resnik, "X-Ray Generator", Soviet Patent A.C.1628235, 1990.
- [21] A. Pokryvailo, and A. Starchikov, "X-Ray Generator", Soviet Patent A.C.1220141, 1985.



Alex Pokryvailo (M'05-SM'07) was born in Vyborg, Russia. He received the M.Sc. and Ph.D. degrees in electrical engineering from the Leningrad Polytechnic Institute in 1975 and 1987, respectively. Formerly with Soreq NRC, Israel, now he is with Spellman High Voltage Electronics Corp., serving as Director of Research. His current and recent experience relates to design of HV high-power switch-mode power supplies, Pulsed Power, with emphasis on high-current opening and closing switches and magnetic design, fast diagnostics, and corona discharges. Previously, he studied switching arcs, designed SF6-insulated switchgear, made research in the area of interaction of flames with electromagnetic fields, etc. He published over 120 papers, two textbooks (in Hebrew), and more than 20 patents pertaining to HV technology.

Cliff Scapellati (M'92), photograph and biography not available at the time of publication.

Analysing Electric Field Distribution in Non-Ideal Insulation at Direct Current

Alex Pokryvailo

Spellman High Voltage Electronics Corporation

Abstract –It is not uncommon for young electrical engineers to overlook the influence of the insulation leakage on the electric field distribution at DC or slow-varying voltage. A classic problem is revisited: distribution of the electric field between two infinite parallel plates separated by two layers of isotropic insulation. Systematic mistakes ensuing from incorrect application of the boundary condition that is valid only for electrostatics are analyzed. Instead, a more general boundary condition should be used. It is obtained from the current continuity equation in its integral form and is expressed in terms of the normal components of the density of full current. The equivalent circuit approach is useful as a complementary method to analyzing the problem, especially when the conduction and displacement currents are commensurable. Numerical field solutions are given for two practical insulation systems.

I. INTRODUCTION

Electrical insulation in high-voltage apparatus is stressed by various voltage waveforms. They range from many MHz to 50/60Hz AC voltages and from fast transients to DC voltage. For many devices, slow transients are common. For example, a soft start in a precision power supply may continue several tens of seconds. In the same power supply very fast transients may occur during a load breakdown, e.g., a sparking in an X-ray tube. In long-pulse applications, a DC voltage is established in anywhere from microseconds to many milliseconds, the latter being the case for computer tomography.

Good insulation design calls for the calculation of electric field that depends not only on geometry, property of materials, the voltage amplitude, etc., but on the voltage waveshape as well. For an experienced practicing high voltage engineer, no questions arise in differentiating between electric field distribution at AC, fast and slow transient and steady-state (DC) conditions in identical insulation systems. Of course, in DC systems, the conduction currents govern the field distribution, while during fast transient processes and at AC, presumably at a line frequency of 50Hz and higher, the displacement currents are of the major importance. Put alternatively, the material conductivity is dominant at DC, and the material permittivity is dominant at AC. This is a well-known code of practice [1-3].

Surprisingly, very few of electrical engineering students that had taken regular undergraduate courses on electromagnetic fields identify or associate the electric field problem with insulation conductivity. The same is true with young high voltage engineers and electrical engineers *en masse*. Even more surprisingly, quite a few mature physicists, holding Ph.D. degrees, were perplexed when trying to calculate the distribution of the electric field in a capacitor with layered insulation at DC conditions (see below). This picture observed by the author during many years of professional communication and teaching clearly indicates that there is a gap between the courses on electromagnetic fields and the courses on high voltage engineering, at least on the undergraduate level. On the other side, it is uncommon to offer in these courses a crisp, lucid formulation of the distinction between the electric field distribution in real insulation at steady-state and at AC or time-varying conditions. Accordingly, the purport of this tutorial paper is offering such a formulation; it might save young electrical engineers some pain and embarrassment.

II. CASE STUDY--FLAT CAPACITOR WITH LAYERED INSULATION

Let us revisit a classic problem having basic importance in high voltage engineering--distribution of the electric field between two infinite parallel plates separated by two layers of isotropic insulation (Fig. 1).

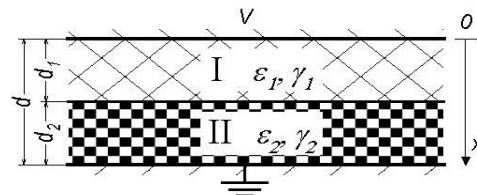

Fig. 1. Flat capacitor with two layers of non-ideal isotropic insulation.

The dielectrics are not ideal, which is reflected by the final values of their conductivities γ_1 , γ_2 . Voltage V that is

¹ This is a revised version of a paper presented at Electrimacs 2008, Quebec, 8-11 June 2008

TECHNICAL ARTICLES ABOUT HVPS and HV ELECTRONICS

Research Papers

applied to the plates, is either a constant V_0 (DC case), ramp, or a sinusoidal function of time $V = V_m \sin \omega t$. The examination will be further simplified by adopting $\omega = 2\pi \cdot 50$, and ascribing to the material properties concrete values: $\varepsilon_1 = 2.3\varepsilon_0$, $\varepsilon_2 = 5\varepsilon_0$, where ε_1 , ε_2 are dielectric I, II permittivities, respectively, and ε_0 is the permittivity of free space, $\gamma_1 = 10^{-15} \Omega^{-1}m^{-1}$, $\gamma_2 = 10^{-12} \Omega^{-1}m^{-1}$. (Dielectric I may be a polyethylene and dielectric II may be an epoxy compound.) Formation of space charge, temperature, frequency and field dependence of the dielectric properties, etc., are neglected at this stage. Thus, the problem is defined physically. How it is usually approached?

A. Field Analysis

Unfailingly, one recognizes that the problem is described by the Laplace equation in its simplest form:

$$\frac{d^2 \varphi}{dx^2} = 0, \quad (1)$$

where φ is the potential and x the coordinate, as shown in Fig. 1. Integrating (1) in the layers, one readily obtains the following relations:

$$E_1 = \text{const}, E_2 = \text{const}, \quad (2)$$

$$V = E_1 d_1 + E_2 d_2, \quad (3)$$

where E_1 , E_2 are yet unknown electric field components in layers I, II, respectively. A boundary condition is necessary to find the relation between E_1 , E_2 . Here comes a common fallacy. Almost invariably, the boundary condition is written in its simplest, and best-known, form [1, 4, 5, 7, 8]

$$D_{n1} = D_{n2}, \text{ or } \varepsilon_1 E_{n1} = \varepsilon_2 E_{n2}, \quad (4)$$

where D_{n1} , D_{n2} and E_{n1} , E_{n2} are the normal components of the displacement vector and the electric field, respectively. The tangential components are zero in this case in view of symmetry. Equation (3), (4) yield the solution [4, par. 4.3.1]:

$$E_1 = \frac{V}{d_1 + \frac{\varepsilon_1}{\varepsilon_2} d_2}, E_2 = \frac{V}{d_1 \frac{\varepsilon_2}{\varepsilon_1} + d_2}, \quad (5)$$

which is quite acceptable for the adopted values at 50Hz, since the conduction current is negligible compared to the displacement current. Note that this idea usually eludes the students, since they are guided by the boundary condition (4), which utterly discards the conductivity.

However, (4) and (5) are not valid for a DC case (and, in a rigorous approach, never, if the conductivities are not zero), because the surface charge exists on the boundary between the dielectrics. The normal components of the electric field strength are related as follows:

$$\varepsilon_1 E_{n1} = \varepsilon_2 E_{n2} + \sigma, \quad (6)$$

where σ is the surface charge density. Note that (6) is a proper boundary condition for the electrostatic problem only, when σ is prescribed. Otherwise, (6) serves solely for the calculation of σ after the field distribution has been found [6]. *This point is almost invariably missed.*

A more general boundary condition that is obtained from the current continuity equation in its integral form

$$\oint_A \delta dA = 0 \quad (7)$$

is expressed in terms of the normal components of the current density δ :

$$\delta_{n1} = \delta_{n2}, \quad (8)$$

or

$$\gamma_1 E_{n1} + \varepsilon_1 \frac{\partial E_{n1}}{\partial t} = \gamma_2 E_{n2} + \varepsilon_2 \frac{\partial E_{n2}}{\partial t}. \quad (9)$$

For sine waveforms, (9) transforms to

$$(\gamma_1 + j\varepsilon_1 \omega) E_{n1} = (\gamma_2 + j\varepsilon_2 \omega) E_{n2}. \quad (9a)$$

Note that δ accounts for both the conduction (first member in (9)) and the displacement mechanism (second member in (9)). For most engineering applications, either the conduction current γE is negligible compared to the displacement current $\varepsilon \frac{\partial E}{\partial t}$:

$$\gamma_i E_{ni} \ll \varepsilon_i \frac{\partial E_{ni}}{\partial t}, i=1,2, \quad (10)$$

or the other way around:

$$\gamma_i E_{ni} \gg \varepsilon_i \frac{\partial E_{ni}}{\partial t}, i=1,2, \quad (10a)$$

If the relation (10) holds, (9) transforms to its simplified form (4), and as such is commonly applied to high voltage field problems at 50/60Hz and higher frequencies. For this case study (50Hz), the ratio of the displacement current amplitude to that of the conduction current for layers I, II is $6.39 \cdot 10^6$ and $1.39 \cdot 10^4$, respectively.

In a DC field, the time derivatives are zero; therefore, boundary condition (9) contains only the media conductivities:

TECHNICAL ARTICLES ABOUT
HVPS and HV ELECTRONICS

Research Papers

$$\gamma_1 E_{n1} = \gamma_2 E_{n2} \quad (11)$$

Since for the examined problem $\gamma_1 \ll \gamma_2$, the stress in the first layer is much greater than in the second: $E_{n1} \gg E_{n2}$, and if d_1 and d_2 are commensurable, the solution is obtained immediately from (3):

$$E_1 \approx \frac{V}{d_1}, \quad E_2 \approx \frac{\gamma_1}{\gamma_2} E_1 = 0.001 E_1.$$

The exact solution is identical to (5), where the permittivities are substituted by the conductivities:

$$E_1 = \frac{V}{d_1 + \frac{\gamma_1}{\gamma_2} d_2}, \quad E_2 = \frac{V}{d_1 \frac{\gamma_2}{\gamma_1} + d_2} \quad (12)$$

Equation (11) is a well-known boundary condition that is applied to static field problems in *conducting* media. However, as mentioned already, given the problem Fig. 1, where seemingly insulating materials are shown, students fail to associate it with the proper boundary condition (11). Majority of them were not introduced to a more general boundary condition (9) in preceding courses.

B. Equivalent Circuits

A simpler approach, not involving field quantities, is using equivalent circuits; by obvious reasons, this approach has larger appeal to electrical engineers than to physicists. A quick glance at Fig. 1 readily yields an equivalent circuit Fig. 2, where

$$R_1 = \frac{d_1}{\gamma_1}, \quad R_2 = \frac{d_2}{\gamma_2}, \quad C_1 = \frac{\epsilon_1}{d_1}, \quad C_2 = \frac{\epsilon_2}{d_2} \quad (13)$$

are resistances and capacitances of the layers per unit area.

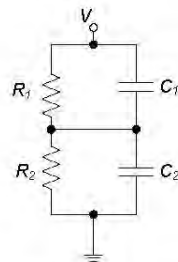

Fig. 2. Equivalent circuit for flat capacitor with two layers of non-ideal insulation.

Solving the corresponding differential equations provides a solution for arbitrary voltage V waveforms allowing to find the voltages across the circuit components, and thus across the insulation layers. Fig. 3a illustrates the voltage distribution across 1-cm-thick layers at the application of a

“long” pulse with a “slow” 30-s ramp, with the materials properties as defined for Fig. 1 (the graphics were conveniently obtained using a PSpice solver); Fig. 3b gives the same except the conductivities are swapped: $\gamma_1=10^{-12} \Omega^{-1}m^{-1}$, $\gamma_2=10^{-15} \Omega^{-1}m^{-1}$. The voltage distributions in Fig. 3a can be assessed, at least at the leading edge, using the frequency sweep of Fig. 3c.

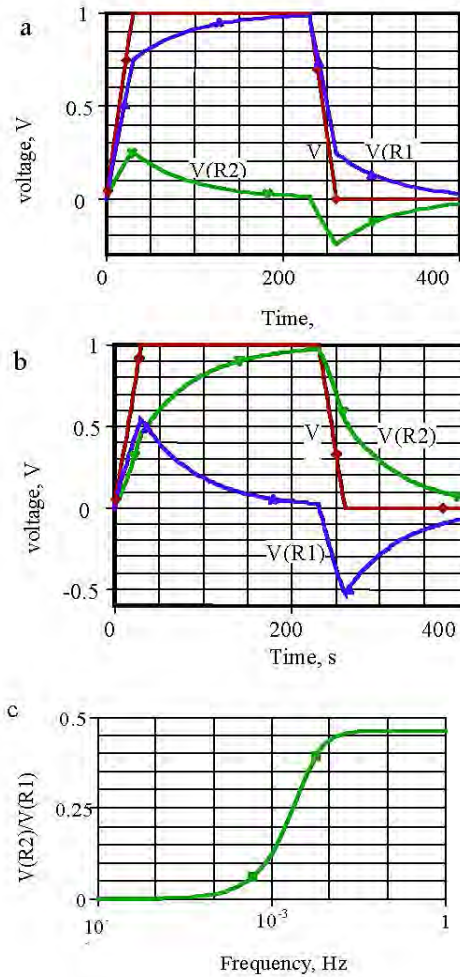

Fig. 3. Solution for equivalent circuit Fig. 2 for parameters as defined for Fig. 1. Layers’ thickness $d_1=d_2=0.01$ m, $\epsilon_1=2.3\epsilon_0$, $\epsilon_2=5\epsilon_0$; a - $\gamma_1=10^{-15} \Omega^{-1}m^{-1}$, $\gamma_2=10^{-12} \Omega^{-1}m^{-1}$, b - $\gamma_1=10^{-12} \Omega^{-1}m^{-1}$, $\gamma_2=10^{-15} \Omega^{-1}m^{-1}$, c - $\gamma_1=10^{-15} \Omega^{-1}m^{-1}$, $\gamma_2=10^{-12} \Omega^{-1}m^{-1}$.

As simple as that, the equivalent circuit approach lacks physical insight and should be used as a complementary method in treating field problems in leaky media. In particular, the surface charge formation that is critical to the insulation functioning (it is responsible for the voltage reversal in Fig. 3) is totally hidden behind the circuit equations. Moreover, in more complex geometries calling for a numerical analysis, the circuit approach is quite impotent; it does not suggest a clue to defining the problem. A couple of

TECHNICAL ARTICLES ABOUT HVPS and HV ELECTRONICS

Research Papers

such examples are given in the following section.

III. NUMERICAL EXAMPLES

The first example makes use of a coil wound on a high-quality plastic bobbin, e.g., polyethylene ($\epsilon_1=2.3\epsilon_0$), that is further potted in an epoxy ($\epsilon_1=5\epsilon_0$). In the below example, their conductivities are related as 1:100, respectively.

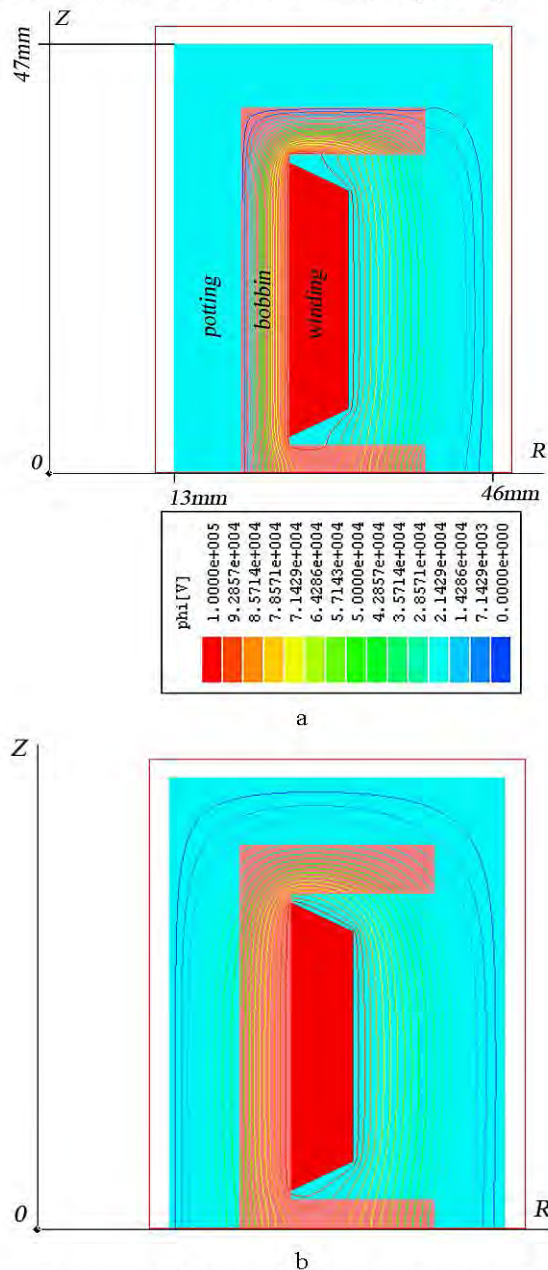

Fig. 4. Distribution of electric field in potted coil. a – DC field (conduction problem); b – AC (electrostatic problem).

Fig. 4 shows the field patterns in the form of equipotential lines for DC (a) and AC (transient) cases (b),

respectively. The solution was obtained using Maxwell 2D SV software [9] in an axisymmetric approximation with the mesh size of about 20,000 triangles. Only half of the coil was modeled owing to mirror image symmetry in the R- θ -plane. The outer boundary is maintained at zero potential (except the R- θ -plane, where the normal component of the E -vector is zero), and a voltage of 100kV is applied to the coil. A similar problem was addressed in [10].

For the DC case Fig. 4a, a large difference in the conductivities forces the field to concentrate in the bobbin leaving the potting largely unstressed at the yokes and the inner leg (to the left) of the core. The rationale of this design is relieving the potting material that is more prone to contain defects than its plastic counterpart [10]. On the opposite, the voltage is shared approximately equally by the plastic and potting at AC conditions (Fig. 4b).

The second example depicts the field distribution in an X-ray tube-shield insulation system. Earlier, a similar problem was solved in [11]. With considerable simplification, the problem again was modeled in an axisymmetric approximation with the mesh size of about 20,000 triangles. There are four distinctly different dielectric regions: vacuum inside the tube, the glass envelope, oil, and a plastic barrier.

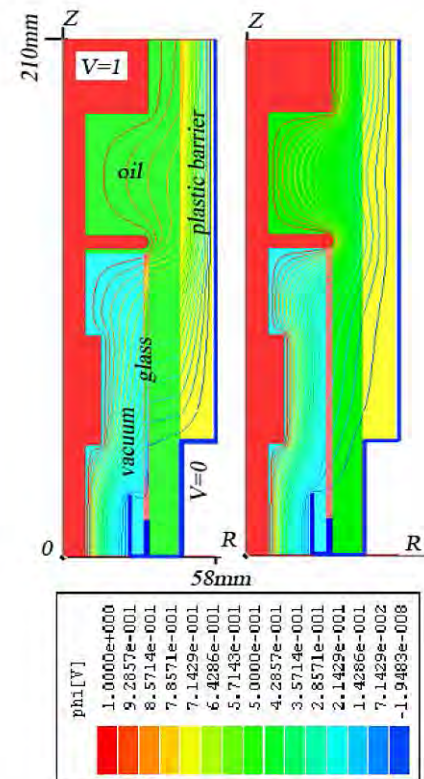

Fig. 3. Distribution of electric field (DC case to the left, AC to the right) in a shielded X-ray tube.

Two cases have been simulated. For the steady-state analysis, the conductivities of materials control the field. In

TECHNICAL ARTICLES ABOUT
HVPS and HV ELECTRONICS

Research Papers

the following simulations, the conductivities of vacuum, glass, oil and plastic, arguably, were taken in the following ratio: 10^{-13} : 10^{-14} : 10^{-13} : 10^{-12} : 10^{-13} . Their relative permittivities were set as 1, 5.75, 2.25, 3.5, respectively. Note that the vacuum “conductivity” is very strongly field- and polarity dependent [12]. In some actual X-ray tubes, the dark currents increase typically by an order of magnitude for the field increase of 5% [13].

Again, this example illustrates a striking difference between the DC and AC (transient) field distributions. The oil is largely unstressed in the first case, with tendency for even lower stress in the process of the oil aging. The plastic barrier is instrumental for the insulation functioning bearing the brunt of the applied voltage. At AC, the oil is stressed much stronger; contrary to the DC case, the field distribution would remain practically unaffected by time.

Although in the above examples both the geometry and physical properties are treated with great simplification, the field analysis is useful in that it allows a) identifying the basic difference in operation under DC and AC, or transient conditions, and b) finding overstressed regions. An experienced designer may well manage the first part without investing time in detailed simulations using proper boundary conditions and equivalent circuits.

IV. NONLINEAR ASPECTS

After accepting the *existence* of a leakage current-governed field distribution, one starts enquiring about more subtle non-linear aspects. The latter are of the utmost importance at DC or quasi-DC operation. A classic example is a DC power cable under current load. With the central conductor having high temperature, the field becomes stronger at the shield—the situation unthought-of at a line frequency (see, e.g., [3], [14]).

In highly non-uniform fields, space charge effects caused by local ionization in the insulation body, field emission, etc., modify the field distribution considerably. These phenomena are not necessarily limited to the case of partial discharges occurring in the insulation cavities. In fact, a “steady-state” distribution is a misnomer at high stresses under the application of a DC voltage: the space and surface charges form and disappear rendering a dynamic field distribution. Similar phenomena are observed in moving media, e.g., in dielectric liquids under the application of a non-uniform electric field. Even in the *absence* of ionization, polar matter circulates because of the electro-convection. The driving forces that are proportional to the field gradient and the liquid (or gas) dipole moment are quite sufficient to provide effective mixing and cooling in various DC apparatuses, e.g., in oil-insulated power supplies. An example of a “gas pump” resulting in flame extinction is given in [15]. Owing to the movement, hot and cold regions having different conductivities (high and low, respectively) migrate, continuously modifying the electric field distribution. Such behaviour is extremely difficult to quantify, especially in ionized media. We note that although even commercial packages have non-linear solvers allowing modelling

materials properties as a function of field and temperature, calculations of the DC electric field in complex structures seldom carry valuable *quantitative* information. An exception to this statement are the cases when dielectric properties are well-known [16]. However, we believe that even *qualitative* understanding is a valuable tool for successful design.

V. CONCLUSION

The above study shows that the boundary condition (9) provides clear physical basis to typical high voltage problems, where one must account for the insulation non-ideality. On the contrary, the boundary condition (4) is misleading in that it does not contain the insulation conductivity; it should be introduced as a reduction of (9). Equation (6) does account for the conduction current but has no use for the electric field calculation in real-life insulation.

More complicated cases, when the conduction and displacement currents are commensurable (for the examined problem of section II, it is a subherz range), should be treated more rigorously. Likewise, attention should be paid to non-linear issues. Note that for simple insulation systems, such as multilayer flat, cylindrical or spherical capacitor, the problem is handled conveniently by using equivalent R-C circuits. This approach works well with electrical engineering students.

VI. ACKNOWLEDGMENT

The author acknowledges the support given by Spellman High Voltage Electronics Corporation in making this work published.

VII. REFERENCES

- [1] P. Gallagher, "High Voltage: Measurement, Testing and Design". Wiley, 1983, p. 197.
- [2] A.I. Dolginov, "High Voltage Engineering". Energia, Moscow, 1968.
- [3] M.S. Khalil, "International Research and Development Trends and Problems of HVDC Cables with Polymeric Insulation". IEEE Electrical Insulation Magazine, Vol. 13, No. 6, 1997, pp. 35-47.
- [4] E., Kuffel, W.S. Zaengl and J. Kuffel, "High Voltage Engineering", 2nd Ed., Newnes, Oxford, 2000, par. 4.3.1 (see also editions 1970, 1984).
- [5] M.S. Naidu and V. Kamaraju, "High Voltage Engineering", 2nd Ed. McGraw Hill, NY, 1995.
- [6] G.A. Grinberg, "Selected Aspects of Mathematical Theory of Electrical and Magnetic Phenomena", Academy of Sciences of USSR, Moscow-Leningrad, 1948, Ch. 1.
- [7] M. Beuer et al., "Hochspannungstechnik", Springer-Verlag, 1986 (Ch. 3, 4), 1992.
- [8] K.J., Binns, P.J. Lawrenson and C.W. Trowbridge, "The Analytical and Numerical Solution of Electric and Magnetic Field", Wiley, NY, 1992.

TECHNICAL ARTICLES ABOUT HVPS and HV ELECTRONICS

Research Papers

- [9] Maxwell® 2D Student Version, Ansoft Corp., Pittsburgh, 2002.
- [10] V. Okun, A. Pokryvailo, and V. Reznik, "Cascade Generator", Certificate of Invention 1198581, 1985, filing date 18 Apr 1984.
- [11] A. Pokryvailo, "Study of Electric Field in Shielded X-Ray Tubes", *Instrumentation and Methods of X-Ray Analysis*, Vol. 31, pp. 151-157, 1983.
- [12] "Handbook of Vacuum Arc Science and Technology". Ed. by Boxman R.L. et al. Noyes Publications, NJ, 1995.
- [13] A. Pokryvailo and V.L. Okun, "An Investigation of Stray Currents of X-Ray Tubes Having Tubular Hollow Anodes", *Instrumentation and Methods of X-Ray Analysis*, v. 32, pp. 120-126, 1984.
- [14] R.N. Hampton, "Some of the Considerations for Materials Operating Under High-Voltage, Direct-Current Stresses", *IEEE Electrical Insulation Magazine*, Vol. 24, No. 1, 2008, pp. 5-13.
- [15] E. Sher, A. Pokryvailo, E. Yacobson, and M. Mond, "Extinction of Flames in a Nonuniform Electric Field", *Combust. Sci. and Tech.*, 1992, Vol. 87, pp. 59-67.
- [16] S. Qin and S. Boggs, "Design Considerations for High Voltage DC Components", *IEEE Electrical Insulation Magazine*, vol. 28, No. 6, 2012, pp. 36-44.

A**ANALYTICAL X-RAY**

is the use of X-Ray Diffraction (XRD), X-Ray Fluorescence (XRF) and various other X-Ray techniques to explore the properties and composition of materials.

ARC LAMPS

are a type of lamp that creates light via the use of an electric arc. Two electrodes are separated by a gas (mercury, argon, krypton, etc) which is ionized by a high voltage source creating a continuous electric arc that emits visible light.

AUTOMATED TEST EQUIPMENT (ATE)

are specialized automated validation devices that are used to test integrated circuits, printed circuit boards or other types of electronic devices or assemblies.

B**BAGGAGE SCREENING**

is the inspection of commercial and personal baggage to locate contraband substances using X-Ray analysis and other inspection techniques.

BONE DENSITOMETRY

is a medical X-Ray technique used to measure the amount of matter per square centimeter of human bone for the prediction and treatment of Osteoporosis.

BOMB DETECTION SYSTEMS

are automated Explosive Detection Systems (EDS) that use a variety of analytical technologies to inspect baggage for possible bomb or explosive threats.

C**CABLE TESTING**

is an inspection technique using voltage and current from a power source to verify the electrical connections in a cable or wired electrical assembly.

CAPACITOR CHARGING

uses a high voltage power supply to charge a capacitor for pulsed power applications.

CAPILLARY ELECTROPHORESIS (CE)

is an analytic technique used to separate and identify ions by their charge, frictional forces and mass in a conductive liquid medium.

CARGO SCREENING

is the inspection of bulk freight to locate contraband substances using X-Ray analysis and other inspection techniques.

CT SCANNER POWER SUPPLIES

are specialized high voltage power supplies custom designed and fabricated to power high powered medical X-Ray tubes used in Computerized Axial Tomography applications.

CATHODE RAY TUBES (CRT)

are cone shaped vacuum tubes containing an electron gun and used to display graphical information and moving images on a fluorescent screen.

CHANNEL ELECTRON MULTIPLIERS

are vacuum tube structures that multiply incident charge, allowing a single electron to produce a cascading effect of many, many more electrons using a process called secondary emission.

CHANNELTRONS

is a trade name of a specific type of channel electron multiplier, see Channel Electron Multipliers for more details.

COLD CATHODE LAMPS

are a type of lamp that creates amplified secondary electron emission without the use of heated filament (thermionic emission).

CO2 LASERS

are continuous wave gas lasers using carbon dioxide gas as their principal pumping media which have a fundamental output wavelength of 9.4 to 10.6 micrometers.

CORONA GENERATORS

are devices containing a high voltage power supply specifically designed to ionize air to create corona. Typically this process is used to generate ozone which is used for various industrial cleaning and purification applications.

CT GENERATORS

see CT Scanner Power Supplies.

D

DIELECTRIC BREAKDOWN TESTING

is a process of applying a high level test voltage to a cable or assembly to see at what voltage level the insulation will fail.

DIGITAL X-RAY DETECTOR PANEL

uses an X-Ray imaging technology that can create digital X-Ray images without the use of traditional X-Ray film and developing requirements.

E

E-BEAM LITHOGRAPHY

is a technique of scanning a beam of electrons in a patterned method used as part of the elaborate process to fabricate integrated circuits in semiconductor fabrication facilities.

E-BEAM WELDING

is a fusing process where an energetic beam of electrons transfer their kinetic energy as heat upon impacting two metal surfaces, melting the materials together.

E-BEAM EVAPORATION

is a coating process where an electron beam melts materials (insulators or conductors) in a vacuum, causing the material to transfer to a gaseous phase, coating everything in the vacuum chamber with a very fine and controllable mist.

ELECTRO-OPTICS

is a branch of science where materials optical properties can be influenced by the application of an electric field.

ELECTRON MICROSCOPES

use a fine beam of electrons to electronically magnify images of a specimen. Without the inherent limitations of the wavelength of light, electron microscopes can magnify up to one million times.

ELECTRON SPECTROSCOPY FOR CHEMICAL ANALYSIS (ESCA)

is a quantitative spectroscopic technique that measures the elemental composition, empirical formula, chemical and electronic state of the elements that exist within a material.

ELECTROPHORESIS

is the motion of dispersed particles relative to a fluid under the influence of a uniform electric field.

ELECTROPORATION

is a process that causes a significant increase in the electrical conductivity and permeability of the cell plasma membrane caused by an externally applied electrical field.

ELECTROSPINNING

is the creation of nano-scaled fibers from an electrically charged liquid. Complex molecules can be accommodated making this well suited for biological fabrication techniques.

ELECTROSTATIC CHUCKS

are clamping work stage devices used in semiconductor fabrication facilities that utilize electrostatic forces to hold a silicon wafer in place during processing.

ELECTROSTATIC DISCHARGE TESTING (ESD)

is the use of high voltage power supplies along with other equipment to simulate the effects of electrostatic charge build up and discharge on electronic equipment and components.

ELECTROSTATIC FLOCKING

is the electrostatically driven application of fine particles to an adhesive coated surface. Typical flock consists of finely cut natural or synthetic fibers of varying size and color.

ELECTROSTATIC LENSES

is a focusing device that uses the principles of electrostatics to influence the movement of charged particles.

ELECTROSTATIC OILERS

are industrial oil spraying apparatus that uses electrostatics to accurately apply oil to desired surfaces.

ELECTROSTATIC PRECIPITATORS

are particulate collection systems that remove particles from a flowing gas using the principles of electrostatic attraction.

ELECTROSTATIC PRINTING

is a printing or copying process where electrostatic forces are used to form the graphical image in powder or ink directly on the surface to be printed.

ELECTROSTATIC SEPARATORS

are sorting devices used in mining or waste recovery applications that use electrostatic forces to separate a mixed composition material stream into its individual components.

ELEMENTAL ANALYZERS

are devices utilizing X-Ray Fluorescence (XRF) technology to determine the composition of raw materials as a quality check in various industrial manufacturing processes.

ENERGY DISPERSIVE X-RAY FLUORESCENCE (EDXRF)

is an analytical spectroscopy technique used for elemental analysis via interactions between electromagnetic radiation and matter, where X-Rays emitted by the matter are analyzed in response to being hit with charged particles.

EXPLOSIVE DETECTION SYSTEMS (EDS)

see Bomb Detection Systems.

F

FLASH LAMPS

are electric glow discharge lamps which produce extremely intense, full-spectrum white light for very short durations.

FLIGHT SIMULATORS

are complex electro-mechanical systems that replicate the experience of flying an aircraft for training purposes. Specialized CRT projectors are frequently used to provide overlapping wide screen displays for realistic visual imagery.

FOCUSED ION BEAM MASK REPAIR (FIB)

Optical Projection Lithography Masks are used in semiconductor processing, as they are the base patterning device of the IC chip. Defects in masks can be fixed via the use of specialized repair equipment utilizing a very fine focused ion beam.

FILL LEVEL INSPECTION

is the process of using automated X-Ray based inspection systems for the verification of properly filled containers typically used in the industrial processing of food.

FOOD INSPECTION

consists of X-Ray inspection techniques that check industrial processed food for bone fragments and foreign contaminants.

G

GAMMA CAMERAS

are devices used to image gamma radiation emitting radioisotopes, a technique known as Scintigraphy.

GAMMA DETECTORS

work by the interaction of a gamma ray with the scintillator material. This interaction produces low-energy light which is then collected and amplified by a photomultiplier tube.

GEL ELECTROPHORESIS

is a separation technique used for deoxyribonucleic acid (DNA), ribonucleic acid (RNA), or protein molecules using an electric field applied to a gel matrix.

H

HIGH VOLTAGE DIVIDERS

are precision strings of high voltage resistors terminated with a low end scaling resistor that provides a proportional low voltage signal that is easily measurable.

HIGH VOLTAGE MEASUREMENT

is the safe technique of making accurate measurements of high voltage signals using high voltage dividers, high impedance meters and applicable corona suppression equipment.

HIGH VOLTAGE PACKAGING

is the technique of high voltage design for industrial fabrication taking into account all variables like corona suppression, insulation prerequisites, breakdown and tracking requirements and material compatibility concerns.

HI POT TESTING

is a process of applying a test voltage to a cable or assembly to confirm it can withstand a particular voltage standoff level.

HOLLOW CATHODE LAMPS (HCL)

are specialized optical lamps used as a spectral line source frequency tuner for light sources such as lasers.

I

INDUCTIVELY COUPLED PLASMA MASS SPECTROMETRY (ICP)

is a type of mass spectrometry capable of determining of a range of metals and non-metals at very low concentrations. This technique is based on inductively coupled plasma used as a method of producing ions with a mass spectrometer detector.

APPLICATIONS GLOSSARY

ION BEAM

is a particle beam comprised of ions

ION BEAM IMPLANTATION

is a process used in semiconductor manufacturing in which ions of a desired material can be implanted into another solid via a high energy ion beam, thereby changing the physical properties of the target material.

ION MILLING

utilizes a high voltage source to ionize low pressure gasses, accelerating and neutralizing them creating a neutral beam of atoms which bombard samples and removes material via a kinetic or chemical process.

ION SOURCES

are electro-magnetic devices used to create charged particles.

IONIZATION CHAMBERS

are the simplest of all gas-filled radiation detectors which are used for the detection and measurement of ionizing radiation.

IMAGE INTENSIFIERS

are vacuum tube devices that increase the intensity of available light in optical systems; fluoresce materials sensitive to X-Ray/Gamma rays radiation; or convert non-visible light to visible spectrum light.

IMPULSE GENERATORS

are electrical devices which produce very short pulse of high voltage or high current by discharging capacitors in series, parallel or series/ parallel configurations for impulse testing.

INDUSTRIAL COLOR PRINTING

see Electrostatic Printing.

INDUSTRIAL CT

is an inspection process for industrial applications utilizing the principles of Computerized Axial Tomography.

INDUSTRIAL MAGNETRONS

are used in large scale microwave heating equipment in applications such as industrial cooking, powder drying and the vulcanization of rubber.

L

LAND BASED POWER FEED EQUIPMENT (PFE) FOR TELECOMMUNICATIONS

consist of sophisticated, redundant, highly reliable high voltage power supplies specifically designed and fabricated to power undersea fiber optic Telecommunications cables.

LASERS

are devices that create and amplify a narrow, intense beam of coherent light.

LEAK DETECTORS

are mass spectrometer based devices that can sense specific gases down to very low concentration levels.

LITHOTRIPSY

is a medical procedure that uses shock waves to break up calcifications in the kidney, bladder, or urethra.

M

MAGNETRONS

are high power vacuum tubes that utilize a stream of electrons within a magnetic field reinforced by resonant cavity amplification to produce high frequency radiation.

MAMMOGRAPHY

is a medical testing procedure using X-Rays to image human breast tissue for the purpose of screening and diagnosing breast cancer.

MARX GENERATORS

are a type of impulse generator, see Impulse Generators.

MATRIX ASSISTED LASER DESORPTION IONIZATION MASS SPECTROMETRY (MALDI)

is a specific mass spectrometry technique used for the analysis of bimolecular and large organic molecules which would be destroyed if ionized by conventional ionization methods.

MATRIX ASSISTED LASER DESORPTION IONIZATION TIME OF FLIGHT MASS SPECTROMETRY (MALDI-TOF)

see Matrix Assisted Laser Desorption Ionization Mass Spectrometry (MALDI).

MEDICAL ONCOLOGY

is the use of radiotherapy (ionizing radiation) for the treatment of malignant cancer.

APPLICATIONS GLOSSARY

MEDICAL IRRADIATION

see Medical Oncology

MEDICAL STERILIZATION

is the use of Gamma radiation to disinfect packaged medical devices and products such as implants, diagnostic kits, catheters and infusion sets.

MICROCHANNEL PLATE DETECTORS

are devices used for detection of electrons, ions, ultraviolet radiation and X-Rays. Similar to an electron multiplier, they operate via the principle of secondary emission.

MICROWAVE GENERATORS

see Magnetrons

MONOBLOCKS[®]

Spellman High Voltage Electronics registered trademarked name for a series of turnkey X-Ray Sources comprised of a high voltage power supply, filament power supply, control electronics and integrated X-Ray tube packaged in a simple, cost effective assembly used in various security, medical and industrial X-Ray analysis applications.

N

NEUTRON GENERATORS

are devices which contain compact linear accelerators and can produce neutrons by fusing isotopes of Hydrogen together.

NON DESTRUCTIVE TESTING (NDT)

are methods used to examine an object, material or system without impairing its future usefulness, typically applied to nonmedical investigations of material integrity.

NON THERMAL PLASMA REACTORS

are devices that generates a low temperature, atmospheric pressure partially ionized gas used for plasma enhanced chemical vapor deposition, plasma etching, and plasma cleaning.

NUCLEAR MEDICINE

is a branch of medicine and medical imaging that uses radioactive isotopes and the process of radioactive decay for the diagnosis and treatment of disease.

NUCLEAR INSTRUMENTATION MODULES (NIM)

is a standard defining mechanical and electrical specifications for electronic modules used in experimental particle and nuclear physics experimentation.

O

OZONE GENERATORS

see Corona Generators.

P

PHOTOLITHOGRAPHY

is the process of transferring geometric shapes on a mask to the surface of a silicon wafer, typically used in semiconductor fabrication facilities to fabricate integrated circuits.

PHOTO MULTIPLIER TUBE DETECTORS (PMT)

are photo vacuum tubes which are extremely sensitive detectors of light in the ultraviolet, visible, and near-infrared ranges of the electromagnetic spectrum.

PIEZOELECTRIC TRANSFORMERS

are non-magnetic transformers that exchange electric potential with mechanical force. Voltage gain is a function of the material coefficient, the number of primary layers and the thickness and overall length of the material.

PLASMA IGNITERS

operate by sending a pressurized gas through a small channel with a charged electrode. When high voltage is applied a powerful spark is generated heating the gas until a plasma torch discharge is created.

PLASMA TORCHES

see Plasma Igniters.

POCKELS CELL

are voltage controlled optical devices that alter the polarization of light which travels through them.

POSITRON EMISSION TOMOGRAPHY (PET)

is a nuclear medicine imaging technique that produces a 3D image of functional processes in the body. The system detects gamma rays emitted by a positron-emitting radionuclide tracer which is introduced into the body on a biologically active molecule.

POWER FEED EQUIPMENT (PFE)

is land or ship board based high voltage power supplies that power fiber optic telecommunication cables. See Land Based Power Feed Equipment (PFE) for Telecommunications for more details.

PRODUCT INSPECTION

utilizes X-Ray based inspection systems that evaluate products for contaminants such as metal, glass, stone and bone. See Food Inspection for more details.

PROPORTIONAL COUNTERS

are radiation detectors used to measure alpha, beta, and X-Ray radiation consisting of a proportional counter tube and associated circuits. Fundamentally similar to a Geiger-Müller counter, but with a different gas and lower tube voltage.

PULSE FORMING NETWORKS (PFN)

accumulate electrical energy over a long time frame then release the stored energy in the form of short duration pulse for various pulsed power applications. A PFN is typically charged via a high voltage power supply, and then rapidly discharged into a load via a high voltage switch.

PULSE GENERATORS

are circuits or a pieces of electronic test equipment used to generate signal pulses of varying amplitude, duty cycle and frequency.

PULSED POWER SUPPLIES

are power supplies with the inherent capability of generating pulsed outputs.

Q

QUADRUPOLE MASS ANALYZERS

are fundamentally comprised of four charged rods, which run parallel to the flight paths of the ions it measures. Ions are filtered and sorted by their mass-to-charge ratio (m/z) by altering the voltages in the rods.

S

SCANNING ELECTRON MICROSCOPES (SEM)

see Electron Microscopes.

SHIPBOARD POWER FEED EQUIPMENT (PFE) FOR TELECOMMUNICATIONS

consist of sophisticated, redundant, highly reliable high voltage power supplies specifically designed to power undersea fiber optic Telecommunications cables while they are being deployed or repaired on board a cable laying ship.

SILICONE ENCAPSULATION

is a solid insulation media frequently used in high voltage power supplies that allow for smaller physical size, high power density and isolation from the physical environment.

SINGLE PHOTO EMISSION COMPUTED TOMOGRAPHY (SPECT)

is a medical imaging technique similar to Positron Emission Tomography (PET), in which a positron-emitting radionuclide tracer is injected into the body. SPECT can be used to diagnose and evaluate a wide range of conditions, including diseases of the heart, cancer, and injuries to the brain.

SPECTROMETERS

are instruments used to measure the properties of light over a specific portion of the electromagnetic spectrum, typically used in spectroscopic analysis to identify materials.

SPECTROPHOTOMETERS

consist of a photometer that can measure intensity as a function of the color (or more specifically the wavelength) of light.

SPUTTERING

is a Physical Vapor Deposition process used to deposit thin films onto a substrate for a variety of industrial and scientific applications. Sputtering occurs when an ionized gas molecule is used to displace atoms of the target material. These atoms bond at the atomic level to the substrate, creating a thin film.

SUBSTANCE IDENTIFICATION SYSTEMS

are specialized apparatus that can identify unknown substances (drugs, explosives, etc.) via the use of various analytical techniques, including but not limited to X-Ray and mass spectrometry.

T

THICKNESS GAUGING

is the use of X-ray Fluorescence (XRF) analytical techniques to determine the thickness of plating, paint or other types of coatings over a base metal.

TIME OF FLIGHT MASS SPECTROMETRY (TOF)

is where ions are accelerated by an electric field down an evacuated flight tube of a specific distance, giving these unknown ions the same kinetic energy. The velocity (hence, time of flight) of the ions depend on their mass-to-charge ratio. Comparing the flight time to known standards, the identity of unknown materials can be determined.

TRACE DETECTION SYSTEMS

are systems using various analytic techniques (X-Ray, Mass Spectrometry, etc.) used to determine if specific contraband substances like drugs or explosive are present.

TRANSMISSION ELECTRON MICROSCOPES (TEM)

are specific types of electron beam microscopes where the transmitted electrons are used to create an image of the specimen. See Electron Microscopes for more details.

U**UV FLASH LAMPS**

consists of four major elements, a high voltage power supply, a pulse forming network, a xenon flash lamp and a trigger circuit. The UV light generated can be used for curing inks, adhesives, coatings and other various industrial applications.

UV WATER PURIFICATION SYSTEMS

are UV light sources used in water sterilizers to kill harmful microorganisms such as bacteria and viruses in untreated water supplies.

V**VACUUM DEPOSITION SYSTEMS**

deposit layers atom by atom, or molecule by molecule, under vacuum conditions on solid surfaces via process like thermal evaporation, sputtering, cathodic arc vaporization, laser ablation or chemical vapor deposition.

VACUUM ION PUMPS

operate by ionizing gases and using a strong electric field to accelerate the generated ions into a solid electrode effectively removing them from the vacuum chamber.

W**WAVELENGTH DISPERSIVE X-RAY FLUORESCENCE (WDXRF)**

is a method used to count the number of X-Rays of a specific wavelength diffracted by a crystal. Typically this technique is used for chemical analysis in X-Ray fluorescence spectrometers.

WIRE LINE LOGGING

is the continuous measurement of oil and gas borehole formation properties with specialized electrically powered instruments to make decisions about drilling and production operations.

X**X-RAY ANALYSIS**

uses various X-Ray analytical techniques to determine properties of known or unknown materials

X-RAY CRYSTALLOGRAPHY

is the study of crystal structures via X-Ray diffraction techniques. When an X-Ray beam strikes a crystalline lattice, the beam is scattered in a specific pattern characterized by the atomic structure of the lattice.

X-RAY DIFFRACTION (XRD)

is used to obtain structural information about crystalline solids, making it useful in biochemistry to solve the three dimensional structures of complex biomolecules.

X-Ray Fluorescence (XRF)

is a process where an unknown sample is bombarded with X-rays causing a disturbance of the electron orbitals which emits secondary fluorescent X-rays of wavelengths. These secondary emissions are detected and analyzed, identifying the material.

X-RAY GENERATORS

are technically any device that has the ability to generate X-Rays. In the power supply industry the term X-Ray generator is frequently used to identify a specialized high voltage power supply that powers an X-Ray tube.

X-RAY INSPECTION

is the industrial use of X-Rays to inspect and analyze material and or products for quality control purposes.

X-RAY PHOTOELECTRON SPECTROSCOPY (XPS)

involves irradiating a sample with X-Rays and measuring the flux of electrons leaving the surface, thus identifying the unknown material.

X-RAY POWDER DIFFRACTION (XRD)

is an analytic technique using X-Rays on powder or microcrystalline samples for structural characterization of the unknown material.

X-RAY SOURCES

are electronic assemblies containing all the required components (high voltage power supply, filament power supply, X-Ray tubes, control electronics, etc) required to generate X-Rays. Spellman "Monoblock[®]" series of products are X-Ray Sources.

A

ABSOLUTE ACCURACY

The correctness of the indicated value in terms of its deviation from the true or absolute value.

AC

In text, use lower case: ac. Abbreviation for Alternating Current.

AC BROWNOUT

The condition that exists when the ac line voltage drops below some specified value.

AC LINE

The set of conductors that route ac voltage from one point to another.

AC LINE FILTER

A circuit filter placed in the ac line to condition or smooth out variations that are higher in frequency than the line frequency.

ALTERNATING CURRENT

(ac) A periodic current the average value of which over a period is zero. Unless distinctly specified otherwise, the term refers to a current which reverses at regularly recurring intervals of time and which has alternately positive and negative values.

AMBIENT TEMPERATURE

The average temperature of the environment immediately surrounding the power supply. For forced air-cooled units, the ambient temperature is measured at the air intake. See also Operating Temperature, Storage Temperature, Temperature Coefficient.

AMPERE

(A) Electron or current flow representing the flow of one coulomb per second past a given point in a circuit.

AMPLIFIER

A circuit or element that provides gain.

AMPLIFIER, DC

A direct coupled amplifier that can provide gain for zero-frequency signals.

AMPLIFIER, DIFFERENTIAL

An amplifier which has available both an inverting and a noninverting input, and which amplifies the difference between the two inputs.

AMPLIFIER, INVERTING

An amplifier whose output is 180° out of phase with its input. Such an amplifier can be used with degenerative feedback for stabilization purposes

AMPLIFIER, NONINVERTING

An amplifier whose output is in phase with its input.

AMPLIFIER, OPERATIONAL

A dc amplifier whose gain is sufficiently large that its characteristics and behavior are substantially determined by its input and feedback elements. Operational amplifiers are widely used for signal processing and computational work.

ANODE

1) (electron tube or valve) An electrode through which a principal stream of electrons leaves the interelectrode space. 2) (semiconductor rectifier diode) The electrode from which the forward current flows within the cell. (IEEE Std 100-1988)

ANSI

Abbreviation for American National Standards Institute

APPARENT POWER

Power value obtained in an ac circuit as the product of current times voltage.

ARC

A discharge of electricity through a gas, normally characterized by a voltage drop in the immediate vicinity of the cathode approximately equal to the ionization potential of the gas. (IEE Std 100-1988)

ASYMMETRICAL WAVEFORM

A current or voltage waveform that has unequal excursions above and below the horizontal axis.

ATTENUATION

Decrease in amplitude or intensity of a signal.

AUTHORIZED PERSON

A qualified person who, by nature of his duties or occupation, is obliged to approach or handle electrical equipment or, a person who, having been warned of the hazards involved, has been instructed or authorized to do so by someone in authority.

TECHNICAL GLOSSARY

AUTO TRANSFORMER

A single winding transformer with one or more taps.

AUTOMATIC CROSSOVER

The characteristic of a power supply having the capability of switching its operating mode automatically as a function of load or setting from the stabilization of voltage to the stabilization of current. The term automatic crossover power supply is reserved for those units having substantially equal stabilization for both voltage and current. Not used for voltage-limited current stabilizers or current-limited voltage stabilizers. See also CROSSOVER POINT.

AUTOMATIC GAIN CONTROL (AGC)

A process or means by which gain is automatically adjusted in a specified manner as a function of input or other specified parameters. (IEEE Std 100-1988)

AUXILIARY SUPPLY

A power source supplying power other than load power as required for the proper functioning of a device.

AWG

Abbreviation for American Wire Gauge.

B**BANDWIDTH**

Based on the assumption that a power supply can be modeled as an amplifier, the bandwidth is that frequency at which the voltage gain has fallen off by 3 dB. Bandwidth is an important determinant of transient response and output impedance.

BASEPLATE TEMPERATURE

The temperature at the hottest spot on the mounting platform of the supply.

BEAD

A small ferrite normally used as a high frequency inductor core.

BEAM SUPPLY

Power supply which provides the accelerating energy for the electrons or ions.

BENCH POWER SUPPLY

Power source fitted with output controls, meters, terminals and displays for experimental bench top use in a laboratory.

BIAS SUPPLY

Power source fitted with output controls, meters, terminals and displays for experimental bench top use in a laboratory.

BIFILAR WINDING

Two conductors wound in parallel.

BIPOLAR

Having two poles, polarities or directions.

BIPOLAR PLATE

An electrode construction where positive and negative active materials are on opposite sides of an electronically conductive plate.

BIPOLAR POWER SUPPLY

A special power supply which responds to the sense as well as the magnitude of a control instruction and is able to linearly pass through zero to produce outputs of either positive or negative polarity.

BIT

A binary unit of digital information having a value of "0" or "1". See also Byte.

BLACK BOX

Element in a system specified by its function, or operating characteristics.

BLEED

A low current drain from a power source.

BLEED RESISTOR

A resistor that allows a small current drain on a power source to discharge filter capacitors or to stabilize an output.

BOBBIN

1) A non-conductive material used to support windings.
2) A cylindrical electrode (usually the positive) pressed from a mixture of the active material, a conductive material, such as carbon black, the electrolyte and/or binder with a centrally located conductive rod or other means for a current collector.

BODE PLOT

A plot of gain versus frequency for a control loop. It usually has a second plot of phase versus frequency.

BOOST REGULATOR

One of several basic families of switching power supply topologies. Energy is stored in an inductor during the pulse then released after the pulse.

C

BREAKDOWN VOLTAGE

- 1) The voltage level which causes insulation failure.
- 2) The reverse voltage at which a semiconductor device changes its conductance characteristics.

BRIDGE CIRCUIT

Circuit with series parallel groups of components.

BRIDGE CONVERTER

A power conversion circuit with the active elements connected in a bridge configuration.

BRIDGE RECTIFIER

Full-wave rectifier circuit employing two or more rectifiers in a bridge configuration.

BROWNOUT

The condition created during peak usage periods when electric utility companies intentionally reduce their line voltage by approximately 10 to 15 percent to counter excessive demand.

BUCK REGULATOR

The condition created during peak usage periods when electric utility companies intentionally reduce their line voltage by approximately 10 to 15 percent to counter excessive demand.

BUFFER

An isolating circuit used to prevent a driven circuit from influencing a driving circuit. (IEEE Std 100-1988)

BUFFER

The energy storage capacitor at the front end of a regulator.

BULK VOLTAGE

The energy storage capacitor at the front end of a regulator.

BURN IN

The operation of a newly fabricated device or system prior to application with the intent to stabilize the device, detect defects, and expose infant mortality.

BUS

The common primary conductor of power from a power source to two or more separate circuits.

BYTE

A sequence of binary digits, frequently comprised of eight (8) bits, addressed as a unit. Also see BIT.

CAPACITANCE

Inherent property of an electric circuit or device that opposes change in voltage. Property of circuit whereby energy may be stored in an electrostatic field.

CAPACITANCE-DISTRIBUTED

The capacitance in a circuit resulting from adjacent turns on coils, parallel leads and connections.

CAPACITIVE COUPLING

Coupling resulting from the capacitive effect between circuit elements.

CAPACITANCE, DISTRIBUTED

The current flow between segregated conductive metal parts; voltage and frequency dependent.

CAPACITOR

A device that stores a charge. A simple capacitor consists of two conductors separated by a dielectric. A device that stores a charge. A simple capacitor consists of two conductors separated by a dielectric.

CAPACITOR INPUT FILTER

Filter employing capacitor as its input.

CATHODE

1) (electron tube or valve) An electrode through which a primary stream of electrons enters the interelectrode space. 2) (semiconductor rectifier diode) The electrode to which the forward current flows within the cell. (IEEE Std 100-1988).

CATHODE RAY TUBE (CRT)

A display device in which controlled electron beams are used to present alphanumeric or graphical data on an electroluminescent screen. (IEEE Std 100-1988).

CATHODE RAY TUBE

An electron-beam tube in which the beam can be focused to a small cross section on a luminescent screen and varied in position and intensity to produce a visible pattern. (IEEE Std 100-1988).

CENTER TAP

Connection made to center of an electronic device.

CGS UNIT

Abbreviation for the Centimeter-Gram Second Unit of measurement.

TECHNICAL GLOSSARY

CHARGE

1) The conversion of electrical energy, provided in the form of a current from an external source, into chemical energy within a cell or battery. 2) The potential energy stored in a capacitive electrical device.

CHASSIS

The structure supporting or enclosing the power supply.

CHASSIS GROUND

The voltage potential of the chassis.

CHOKE COIL

An inductor.

CHOKE, RF

A choke coil with a high impedance at radio frequencies.

CIRCUIT INPUT FILTER

A filter employing an inductor (L) or an inductor/capacitor (L/C) as its input.

CIRCULAR MIL

Cross-sectional area of a conductor one mil in diameter.

CIRCULATING CURRENT

See GROUND LOOP.

CLAMP DIODE

A diode in either a clipper or clamp circuit.

CLIPPER CIRCUIT

A circuit that blocks or removes the portion of a voltage waveform above some threshold voltage.

CLOSED LOOP CONTROL

A type of automatic control in which control actions are based on signals fed back from the controlled equipment or system. (IEEE Std 100-1988)

CLOSED-LOOP CONTROL SYSTEM

(control system feedback) A control system in which the controlled quantity is measured and compared with a standard representing the desired performance.

Note: Any deviation from the standard is fed back into the control system in such a sense that it will reduce the deviation of the controlled quantity from the standard. (IEEE Std 100-1988)

COLLECTOR

1) Electronic connection between the electrochemical cell electrode and the external circuit. 2) In a transistor, the semiconductor section which collects the majority carriers.

COMMON CHOKE

See INTEGRATED MAGNETICS.

COMMON-MODE NOISE

The component of noise voltage that appears equally and in phase on conductors relative to a common reference.

COMMON-MODE OUTPUT

That electrical output supplied to an impedance connected between the terminals of the ungrounded floating output of a power supply, amplifier, or line-operated device, and the ground point to which the source power is returned.

COMMON POINT

With respect to operationally programmable power supplies one output/sense terminal is designated "common" to which load, reference and external programming signal all return.

COMMON RETURN

A return conductor common to two or more circuits.

COMPARISON AMPLIFIER

A dc amplifier which compares one signal to a stable reference, and amplifies the difference to regulate the power supply power-control elements.

COMPENSATION

The addition of circuit elements to assist in stabilization of a control loop.

COMPLIMENTARY TRACKING

A system of interconnection of two voltage stabilizers by which one voltage (the slave) tracks the other (the master).

COMPLIANCE

Agency certification that a product meets its standards. See also SAFETY COMPLIANCE.

COMPLIANCE VOLTAGE

The output dc voltage of a constant current supply.

COMPLIANCE RANGE

Range of voltage needed to sustain a given constant current throughout a range of load resistance.

CONDUCTANCE (G)

The ability to conduct current. It is equal to amperes per volt, or the reciprocal of resistance, and is measured in siemens (metric) or mhos (English). $G = 1/R$.

CONSTANT CURRENT LIMITING CIRCUIT

Current-limiting circuit that holds output current at some maximum value whenever an overload of any magnitude is experienced.

CONSTANT VOLTAGE CHARGE

A charge during which the voltage across the battery terminals is maintained at a steady state.

CONTINUOUS DUTY

A requirement of service that demands operation at a substantially constant load for an indefinitely long time. See also INTERMITTENT DUTY.

CONTROL GRID

A grid, ordinarily placed between the cathode and an anode, for use as a control electrode. (IEEE Std 100-1988)

CONTROL LOOP

A feedback circuit used to control an output signal. See also LOOP.

CONTROL RANGE

The parameter over which the controlled signal maybe adjusted and still meet the unit specifications.

CONTROL REMOTE

Control over the stabilized output signal by means located outside or away from the power supply. May or may not be calibrated.

CONTROL RESOLUTION

The smallest increment of the stabilized output signal that can be reliably repeated.

CONVECTION-COOLED POWER SUPPLY

A power supply cooled exclusively from the natural motion of a gas or a liquid over the surfaces of heat dissipating elements.

CONVERTER

A device that changes the value of a signal or quantity. Examples: DC-DC; a device that delivers dc power when energized from a dc source. Fly-Back; a type of switching power supply circuit. See also FLYBACK CONVERTER. Forward; a type of switching power supply circuit. See also FORWARD CONVERTER.

CORE

Magnetic material serving as a path for magnetic flux.

CORONA

1) (air) A luminous discharge due to ionization of the air surrounding a conductor caused by a voltage gradient exceeding a certain critical value. 2) (gas) A discharge with slight luminosity produced in the neighborhood of a conductor, without greatly heating it, and limited to the region surrounding the conductor in which the electric field exceeds a certain value. 3) (partial discharge) (corona measurement) A type of localized discharge resulting from transient gaseous ionization in an insulation system when the voltage stress exceeds a critical value. The ionization is usually localized over a portion of the distance between the electrodes of the system. (IEEE Std 100-1988)

CORONA EXTINCTION VOLTAGE

(CEV) (corona measurement) The highest voltage at which continuous corona of specified pulse amplitude no longer occurs as the applied voltage is gradually decreased from above the corona inception value. Where the applied voltage is sinusoidal, the CEV is expressed as 0.707 of the peak voltage. (IEEE Std 100-1988)

CORONA INCEPTION VOLTAGE

(CIV) (corona measurement) The lowest voltage at which continuous corona of specified pulse amplitude occurs as the applied voltage is gradually increased. Where the applied voltage is sinusoidal, the CIV is expressed as 0.707 of the peak voltage. (IEEE Std 100-1988)

CREEPAGE

The movement of electrolyte onto surfaces of electrodes or other components of a cell with which it is not normally in contact.

CREEPAGE DISTANCE

The shortest distance separating two conductors as measured along a surface touching both conductors.

CROSS-REGULATION

In a multiple output power supply, the percent voltage change at one output caused by the load change on another output.

CROSSOVER POINT

That point on the operating locus of a voltage/current automatic crossover power supply formed by the intersection of the voltage-stabilized and current-stabilized output lines. The resistance value (E/I) defined by this intersection is the matching impedance of the power supply, which will draw the maximum output power. See also AUTOMATIC CROSSOVER.

TECHNICAL GLOSSARY

CROSSOVER, VOLTAGE/CURRENT

Voltage/Current crossover is that characteristic of a power supply that automatically converts the mode of operation from voltage regulation to current regulation (or vice versa) as required by preset limits.

CROWBAR

An overvoltage protection circuit which rapidly places a low resistance shunt across the power supply output terminals if a predetermined voltage is exceeded.

CSA

Abbreviation for Canadian Standards Association.

CURRENT CONTROL

See CURRENT STABILIZATION

CURRENT FOLDBACK

See FOLDBACK CURRENT LIMITING.

CURRENT LIMIT KNEE

The point on the plot of current vs voltage of a supply at which current starts to foldback, or limit.

CURRENT LIMITING

An electronic overload protection circuit which limits the maximum output current to a preset value.

CURRENT MODE

The functioning of a power supply so as to produce a stabilized output current.

CURRENT SENSING RESISTOR

A resistor placed in series with the load to develop a voltage proportional to load current.

CURRENT SOURCE

A power source that tends to deliver constant current.

CURRENT STABILIZATION

The process of controlling an output current.

D**DC**

In text, use lower case: dc. Abbreviation for Direct Current.

DC COMPONENT

The dc value of an ac wave that has an axis other than zero.

DC-DC CONVERTER

A circuit or device that changes a dc input signal value to a different dc output signal value.

DECAY TIME

See FALL TIME

DERATING

(reliability) The intentional reduction of stress/strength ratio in the application of an item, usually for the purpose of reducing the occurrence of stress-related failures. (IEEE Std 100-1988)

DIELECTRIC

An insulating material between conductors.

DIELECTRIC CONSTANT (K)

For a given dielectric material, the ratio of the value of a capacitor using that material to the value of an equivalent capacitor using a standard dielectric such as dry air or a vacuum.

DIELECTRIC WITHSTAND VOLTAGE

Voltage an insulating material will withstand before flashover or puncture.

See also HI-POT TEST, ISOLATION.

DIFFERENTIAL VOLTAGE

The difference in voltages at two points as measured with respect to a common reference.

DRIFT

A change in output over a period of time independent of input, environment or load

DRIVER

A current amplifier used for control of another device or circuit.

DUTY CYCLE

1) The ratio of time on to time off in a recurring event. 2) The operating regime of a cell or battery including factors such as charge and discharge rates, depth of discharge, cycle length and length of time in the standby mode.

DYNAMIC FOCUS

A means of modulating the focus voltage as a function of the beam position. (Bertan High Voltage)

DYNAMIC LOAD

A load that rapidly changes from one level to another. To be properly specified, both the total change and the rate of change must be stated.

TECHNICAL GLOSSARY

E

EARTH

An electrical connection to the earth frequently using a grid or rod(s). See also GROUND.

E-BEAM

Electron Beam. (Bertan High Voltage)

EDDY CURRENTS

A circulating current induced in a conducting material by a varying magnetic field.

EFFECTIVE VALUE

The value of a waveform that has the equivalent heating effect of a direct current. For sine waves, the value is .707 X Peak Value; for non-sinusoidal waveforms, the Effective Value = RMS (Root Mean Square) Value.

EFFICIENCY

1) The ratio of total output power to total input power, expressed as a percentage, under specified conditions.
2) The ratio of the output of a secondary cell or battery on discharge to the input required to restore it to the initial state of charge under specified conditions.

ELECTRIC

Containing, producing, arising from, actuated by, or carrying electricity, or designed to carry electricity and capable of so doing. Examples: Electric eel, energy, motor, vehicle, wave. Note: Some dictionaries indicate electric and electrical as synonymous, but usage in the electrical engineering field has in general been restricted to the meaning given in the definitions above. It is recognized that there are borderline cases wherein the usage determines the selection. See ELECTRICAL. (IEEE Std 100-1988)

ELECTRICAL

(general) Related to, pertaining to, or associated with electricity but not having its properties or characteristics. Examples: Electrical engineer, handbook, insulator, rating, school, unit.

ELECTRON BEAM

A collection of electrons which may be parallel, convergent, or divergent. (Bertan High Voltage)

ELECTRON (e-)

Negatively charged particle.

ELECTRON GUN

(electron tube) An electrode structure that produces and may control, focus, deflect, and converge one or more electron beams. (IEEE Std 100-1988)

ELECTRONIC

Of, or pertaining to, devices, circuits, or systems utilizing electron devices. Examples: Electronic control, electronic equipment, electronic instrument, and electronic circuit. (IEEE Std 100-1988)

ELECTRONIC LOAD

A test instrument designed to draw various and specified amounts of current or power from a power source.

ELECTRON VOLT

A measure of energy. The energy acquired by an electron passing through a potential of one volt.

ELECTROPHORESIS

A movement of colloidal ions as a result of the application of an electric potential. (IEEE Std 100-1988)

EMF

Abbreviation for Electromotive Force.

EMI

Abbreviation for Electromagnetic Interference.

EMI FILTER

A circuit composed of reactive and resistive components for the attenuation of radio frequency components being emitted from a power supply. See also EMI.

EMI FILTERING

Process or network of circuit elements to reduce electromagnetic interference emitted from or received by an electronic device. See also EMI.

EMISSION

1) (laser-maser) The transfer energy from matter to a radiation field. 2) (radio-noise emission) An act of throwing out or giving off, generally used here in reference to electromagnetic energy. (IEEE Std 100-1988)

EMISSION CURRENT

The current resulting from electron emission. (IEEE Std 100-1988)

EQUIVALENT CIRCUIT

An electrical circuit that models the fundamental properties of a device or circuit.

EQUIVALENT LOAD

An electrical circuit that models the fundamental properties of a load.

EQUIVALENT SERIES INDUCTANCE (ESI)

The amount of inductance in series with an ideal capacitor which exactly duplicates the performance of a real capacitor.

EQUIVALENT SERIES RESISTANCE (ESR)

The amount of resistance in series with an ideal capacitor which exactly duplicates the performance of a real capacitor.

ERROR AMPLIFIER

An operational amplifier, or differential amplifier, in a control loop that produces an error signal whenever a sensed output differs from a reference voltage.

ERROR SIGNAL

The output voltage of an error amplifier produced by the difference between the reference and the input signal times the gain of the amplifier.

ERROR VOLTAGE

The output voltage of the error amplifier in a control loop.

ESD

Abbreviation for Electrostatic Discharge.

ESL

Abbreviation for Equivalent Series Inductance.

ESR

Abbreviation for Equivalent Series Resistance.

F**FAILURE MODE**

The way in which a device has ceased to meet specified minimum requirements.

FALL TIME

The time required for a pulse to decrease from 90 percent to 10 percent of its maximum positive (negative) amplitude.

FAN COOLED

A method of forced-air cooling used to maintain design.

FARAD

Unit of measurement of capacitance. A capacitor has a capacitance of one farad when a charge of one coulomb raises its potential one volt: $C = Q/E$.

FEEDBACK

The process of returning part of the output signal of a system to its input.

FEED FORWARD

A control technique whereby the line regulation of a power supply is improved by directly sensing the input voltage.

FEED THROUGH

A plated-through hole in a printed circuit board which electrically connects a trace on top of the board with a trace on the bottom side.

FERRITE

A ceramic material that exhibits low loss at high frequencies, and which contains iron oxide mixed with oxides or carbonates of one or more metals such as manganese, zinc, nickel or magnesium.

FET

Abbreviation for Field Effect Transistor.

FIELD EFFECT TRANSISTOR (FET)

Transistor in which the resistance of the current path from source to drain is modulated by applying a transverse electric field between two electrodes. See also JUNCTION FIELD EFFECT TRANSISTOR, METAL OXIDE, SEMICONDUCTOR FIELD EFFECT TRANSISTOR.

FIELD EMISSION

Electron emission from a surface due directly to high voltage gradients at the emitting surface. (IEEE Std 100-1988)

FIELD EMISSION GUN

An electron gun with an extractor electrode which pulls or extracts electrons off the filament.

FILAMENT

(electron tube) A hot cathode, usually in the form of a wire or ribbon, to which heat may be supplied by passing current through it. Note: This is also known as a filamentary cathode. (IEEE Std 100-1988)

FILAMENT CURRENT

The current supplied to a filament to heat it. (IEEE Std 100-1984)

FILAMENT OUTPUT

Power supply which heats the filament of an electron column, CRT or x-ray tube. In some applications, the filament output "floats" on the accelerating voltage. (Bertan High Voltage)

FILAMENT VOLTAGE

Power supply which heats the filament of an electron column, CRT or x-ray tube. In some applications, the filament output "floats" on the accelerating voltage. (Bertan High Voltage)

FILTER

One or more discrete components positioned in a circuit to attenuate signal energy in a specified band of frequencies.

FLASHOVER

1) (general) A disruptive discharge through air around or over the surface of solid or liquid insulation, between parts of different potential or polarity, produced by the application of voltage wherein the breakdown path becomes sufficiently ionized to maintain an electric arc. 2) (high voltage ac cable termination) A disruptive discharge around or over the surface of an insulating member, between parts of different potential or polarity, produced by the application of voltage wherein the breakdown path becomes sufficiently ionized to maintain an electric arc. 3) (high voltage testing) Term used when a disruptive discharge occurs over the surface of a solid dielectric in a gaseous or liquid medium. (IEEE Std 100-1988)

FLOATING NETWORK OR COMPONENTS

A network or component having no terminal at ground potential. (IEEE Std 100-1988)

FLOATING OUTPUT

Ungrounded output of a power supply where either output terminal may be referenced to another specified voltage.

FLYBACK CONVERTER

A power supply switching circuit which normally uses a single transistor. During the first half of the switching cycle the transistor is on and energy is stored in a transformer primary; during the second half of the switching cycle this energy is transferred to the transformer secondary and the load.

FOCUS

(oscillograph) Maximum convergence of the electron beam manifested by minimum spot size on the phosphor screen. (IEEE Std 100-1988)

FOCUSING ELECTRODE

(beam tube) An electrode the potential of which is adjusted to focus an electron beam. (IEEE Std 100-1988)

FOLDBACK CURRENT LIMITING

A power supply output protection circuit whereby the output current decreases with increasing overload, reaching a minimum at short circuit. This minimizes the internal power dissipation under overload conditions. Foldback current limiting is normally used with linear regulators

FORWARD CONVERTER

A power supply switching circuit that transfers energy to the transformer secondary when the switching transistor is on.

FREE WHEEL DIODE

A diode in a pulse-width modulated switching power supply that provides a conduction path for the counter electromotive force of an output choke.

FREQUENCY

Number of cycles per second (measured in Hertz).

FULL BRIDGE CONVERTER

A power switching circuit in which four power switching devices are connected in a bridge configuration to drive a transformer primary.

FULL BRIDGE RECTIFIER

A rectifier circuit that employs four diodes per phase.

FULL WAVE RECTIFIER

Rectifier circuit that produces a dc output for each half cycle of applied alternating current.

FUSE

Safety protective device that permanently opens an electric circuit when overloaded. See also OVERCURRENT DEVICE, OVERCURRENT PROTECTIVE DEVICE.

G**GAIN**

Ratio of an output signal to an input signal. See also CLOSED LOOP GAIN, GAIN MARGIN, OPEN LOOP GAIN.

GAUSS

Measure of flux density in Maxwells per square centimeter of cross-sectional area. One Gauss is 10⁻⁴ Tesla

GLITCH

1) An undesired transient voltage spike occurring on a signal. 2) A minor technical problem arising in electrical equipment.

TECHNICAL GLOSSARY

GPIB

General purpose interface bus, also known as IEEE-488. (Bertan High Voltage)

GRID

1) In batteries, a framework for a plate or electrode which supports or retains the active materials and acts as a current collector. 2) In vacuum tubes, an element used to control the flow of electrons. 3) A network of equally spaced parallel lines, one set spaced perpendicular to the other.

GROUND

A conducting connection, whether intentional or accidental, by which an electric circuit or equipment is connected to earth, or to some conducting body that serves in place of earth. (National Electric Code)

GROUND BUS

A bus to which individual grounds in a system are attached and that in turn is grounded at one or more points.

GROUNDED

Connected to or in contact with earth or connected to some extended conductive body which serves instead of the earth.

GROUND LOOP

A condition that causes undesirable voltage levels when two or more circuits share a common electrical return or ground lines.

H

HALF-BRIDGE CONVERTER

A switching power supply design in which two power switching devices are used to drive the transformer primary. See also BRIDGE RECTIFIER.

HALF-WAVE RECTIFIER

A circuit element, such as a diode, that rectifies only one-half the input ac wave to produce a pulsating dc output.

HEADROOM

The difference between the bulk voltage and the output voltage in a linear series pass regulator. See also DIFFERENTIAL VOLTAGE.

HEAT SINK

The medium through which thermal energy is dissipated.

HENRY (H)

Unit of measurement of inductance. A coil has one henry of inductance if an EMF of one volt is induced when current through an inductor is changing at rate of one ampere per second

HERTZ (Hz)

The SI unit of measurement for frequency, named in honor of Heinrich Hertz who discovered radio waves. One hertz equals one cycle per second.

HICCUP

A transient condition that momentarily confuses a control loop.

HIGH LINE

Highest specified input operating voltage.

HIGH VOLTAGE ASSEMBLY

The portion of a high voltage power supply which contains the high voltage circuits which are critical to the performance and reliability of a high voltage power supply. (Bertan High Voltage)

HI-POT TEST (HIGH POTENTIAL TEST)

A test performed by applying a high voltage for a specified time to two isolated points in a device to determine adequacy of insulating materials.

HOLDING TIME

See HOLDUP TIME

HOLDUP TIME

The time under worst case conditions during which a power supply's output voltage remains within specified limits following the loss or removal of input power. Sometimes called Holding Time or Ride-Through.

HYBRID SUPPLIES

A power supply that combines two or more different regulation techniques, such as ferroresonant and linear or switching and linear, or one that takes advantage of hybrid technology.

I

I-BEAM

Ion Beam. (Bertan High Voltage)

IC

Abbreviation for Integrated Circuit.

TECHNICAL GLOSSARY

IEC

Abbreviation for International Electrotechnical Commission.

IEEE

Abbreviation for Institute of Electrical and Electronics Engineers.

IMPEDANCE (Z)

Total resistance to flow of an alternating current as a result of resistance and reactance.

INDUCED CURRENT

Current that flows as a result of an Induced EMF (Electromotive Force).

INDUCED EMF

Voltage induced in a conductor in a varying magnetic field.

INPUT

The ability to turn off the output of a power supply from a remote location

INDUCED IMPEDANCE

The impedance of the input terminals of a circuit or device, with the input disconnected.

INDUCED FILTER

A low-pass or band-reject filter at the input of a power supply which reduces line noise fed to the supply. This filter may be external to the power supply.

INDUCED SURGE

See INRUSH CURRENT

INPUT VOLTAGE RANGE

The range of input voltage values for which a power supply or device operates within specified limits.

INRUSH CURRENT

The range of input voltage values for which a power supply or device operates within specified limits.

INSTANTANEOUS VALUE

The measured value of a signal at a given moment in time.

INSULATION

Non-conductive materials used to separate electric circuits.

INSULATION RESISTANCE

The resistance offered, usually measured in megohms, by an insulating material to the flow of current resulting from an impressed dc voltage

INVERTER

1) A device that changes dc power to ac power. 2) A circuit, circuit element or device that inverts the input signal.

ION BEAM

A collection of ions which may be parallel, convergent, or divergent. (Bertan High Voltage)

ION GUN

A device similar to an electron gun but in which the charged particles are ions. Example: proton gun. (IEEE Std 100-1988)

ISOLATION

The electrical separation between two circuits, or circuit elements.

ISOLATION TRANSFORMER

A transformer with a one-to-one turns ratio. See also STEP-DOWN TRANSFORMER STEP-UP TRANSFORMER, TRANSFORMER

ISOLATION VOLTAGE

The maximum ac or dc specified voltage that may be continuously applied between isolated circuits.

J

JOULE (J)

Unit of energy equal to one watt-second.

K

KELVIN (K)

1) Unit of temperature in the International System of Units (SI) equal to the fraction 1/273.16 of the thermodynamic temperature of the triple point of water. The kelvin temperature scale uses Celsius degrees with the scale shifted by 273.16. Therefore, 0 K is at absolute zero. Add 273.16 to any Celsius value to obtain the corresponding value in kelvins. 2) A technique using 4 terminals to isolate current carrying leads from voltage measuring leads.

KIRCHOFF'S CURRENT LAW

At any junction of conductors in a circuit, the algebraic sum of the current is zero

KIRCHOFF'S VOLTAGE LAW

In a circuit, the algebraic sum of voltages around the circuit is equal to zero.

L

LATCH-UP

A part of the control circuit for a power supply that goes into a latched condition.

L-C FILTER

A low pass filter that consists of an inductance (L) and a capacitance (C). Also known as an averaging filter.

LEAKAGE CURRENT

- 1) The ac or dc current flowing from input to output and/or chassis of an isolated device at a specified voltage.
- 2) The reverse current in semiconductor junctions.

LED

Symbol for Light-Emitting Diode.

LINE

- 1) Medium for transmission of electricity between circuits or devices.
- 2) The voltage across a power transmission line. See also HIGH LINE, LOW LINE.

LINEAR

- 1) In a straight line.
- 2) A mathematical relationship in which quantities vary in direct proportion to one another, the result of which, when plotted, forms a straight line.

LINEARITY

- 1) The ideal property wherein the change in the value of one quantity is directly proportional to the change in the value of another quantity, the result of which, when plotted on graph, forms a straight line.
- 2) Commonly used in reference to Linearity Error.

LINEAR SUPPLY REGULATION

The deviation of the output quantity from a specified reference line.

LINEAR PASS

See SERIES PASS

LINEAR REGULATION

A regulation technique wherein the control device, such as transistor, is placed in series or parallel with the load. Output is regulated by varying the effective resistance of the control device to dissipate unused power. See also LINEAR SUPPLY, REGULATION.

LINEAR REGULATOR

A power transformer or a device connected in series with the load of a constant voltage power supply in such a way that the feedback to the series regulator changes its voltage drop as required to maintain a constant dc output.

LINEAR SUPPLY REGULATION

An electronic power supply employing linear regulation techniques. See also LINEAR REGULATION.

LINE CONDITIONER

A circuit or device designed to improve the quality of an ac line.

LINE EFFECT

See LINE REGULATION.

LINE REGULATION

A regulation technique wherein the control device, such as transistor, is placed in series or parallel with the load. Output is regulated by varying the effective resistance of the control device to dissipate unused power. See also LINEAR SUPPLY, REGULATION.

LINE REGULATOR

Power conversion equipment that regulates and/or changes the voltage of incoming power.

LINE TRANSIENT

A perturbation outside the specified operating range of an input or supply voltage.

LOAD

Capacitance, resistance, inductance or any combination thereof, which, when connected across a circuit determines current flow and power used.

LOAD DECOUPLING

The practice of placing filter components at the load to attenuate noise.

LOAD EFFECTS

See LOAD REGULATION

LOAD IMPEDANCE

The complex resistance to the flow of current posed by a load that exhibits both the reactive and resistive characteristics.

LOAD REGULATION

- 1) Static: The change in output voltage as the load is changed from specified minimum to maximum and maximum to minimum, with all other factors held constant.
- 2) Dynamic: The change in output voltage expressed as a percent for a given step change in load current. Initial and final current values and the rates of change must be specified. The rate of change shall be expressed as current/unit of time, e.g., 20 amperes A/μ second. The dynamic regulation is expressed as a \pm percent for a worst case peak-to-peak deviation for dc supplies, and worst case rms deviation for ac supplies.

TECHNICAL GLOSSARY

LOCAL CONTROL

Control over the stabilized output signal by means located within or on the power supply. May or may not be calibrated.

LOCAL SENSING

Using the power supply output voltage terminals as the error-sensing points to provide feedback to the voltage regulator.

LOGIC HIGH

A voltage representing a logic value of one (1) in positive logic.

LOGIC INHIBIT/ENABLE

A referenced or isolated logic signal that turns a power supply output off or on.

LOGIC LOW

A voltage representing a logic value of zero (0) in positive logic.

LONG-TERM STABILITY

The output voltage change of a power supply, in percent, due to time only, with all other factors held constant. Long-term stability is a function of component aging.

LOOP

The path used to circulate a signal. See also CLOSED LOOP, CONTROL LOOP, OPEN LOOP.

LOOP GAIN

The ratio of the values of a given signal from one point to another in a loop. See also GAIN.

LOOP RESPONSE

The speed with which a loop corrects for specified changes in line or load.

LOOP STABILITY

A term referencing the stability of a loop as measured against some criteria, e.g., phase margin and gain margin.

LOW LINE

Lowest specified input operating voltage.

M

MAINS

The utility AC power source.

MASTER-SLAVE OPERATION

A method of interconnecting two or more supplies such that one of them (the master) serves to control the others (the slaves). The outputs of the slave supplies always remain equal to or proportional to the output of the master

MAXIMUM LOAD

1) The highest allowable output rating specified for any or all outputs of a power supply under specified conditions including duty cycle, period and amplitude. 2) The highest specified output power rating of a supply specified under worst case conditions.

MINIMUM LOAD

1) The lowest specified current to be drawn on a constant voltage power supply for the voltage to be in a specified range. 2) For a constant current supply, the maximum value of load resistance.

MODULAR

1) A physically descriptive term used to describe a power supply made up of a number of separate subsections, such as an input module, power module, or filter module. 2) An individual power unit patterned on standard dimensions and capable of being integrated with other parts or units into a more complex and higher power system.

MODULATOR

The control element of a switching power supply.

MOSFET

Abbreviation for Metal Oxide Semiconductor Field Effect Transistor.

MTBF

Abbreviation for Mean Time Between Failure.

N

NEGATIVE FEEDBACK

1) (circuits and systems) The process by which part of the signal in the output circuit of an amplifying device reacts upon the input circuit in such a manner as to counteract the initial power, thereby decreasing the amplification. 2) (control) (industrial control) A feedback signal in a direction to reduce the variable that the feedback represents.

3) (degeneration) (stabilized feedback) (data transmission)
The process by which a part of the power in the output circuit of an amplifying device reacts upon the input circuit in such a manner as to reduce the initial power, thereby reducing the amplification. (IEEE Std 100-1988)

NEGATIVE RAIL

The more negative of the two conductors at the output of a power supply.

NEGATIVE REGULATOR

A voltage regulator whose output voltage is negative compared to the voltage at the return.

NEGATIVE TEMPERATURE COEFFICIENT

A decreasing function with increasing temperature. The function may be resistance, capacitance, voltage, etc.

NODE

The junction of two or more branches in a circuit.

NOISE

The aperiodic random component on the power source output which is unrelated to source and switching frequency. Unless specified otherwise, noise is expressed in peak-to-peak units over a specified bandwidth.

NO LOAD VOLTAGE

Terminal voltage of battery or supply when no current is flowing in external circuit. See OPEN CIRCUIT VOLTAGE

NOMINAL VALUE

The stated or objective value of a quantity or component, which may not be the actual value measured.

NOMINAL VOLTAGE

The stated or objective value of a given voltage, which may not be the actual value measured.

O**OFF LINE POWER SUPPLY**

1) A power supply in which the ac line is rectified and filtered without using a line frequency isolation transformer.
2) A power supply switched into service upon line loss to provide power to the load without significant interruption. See also UNINTERRUPTIBLE POWER SUPPLY.

OFFSET CURRENT

The direct current that appears as an error at either terminal of a dc amplifier when the input current source is disconnected.

OFFSET VOLTAGE

The dc voltage that remains between the input terminals of a dc amplifier when the output current voltage is zero

OHM

Unit of measure of resistance

OP-AMP

Abbreviation for Operational Amplifier

OHM

The difference in potential between the terminals of a cell or voltage when the circuit is open (no-load condition). See NO LOAD VOLTAGE.

OPEN-FRAME CONSTRUCTION

A construction technique where the supply is not provided with an enclosure.

OPEN LOOP

A signal path without feedback.

OPEN LOOP GAIN

Ratio of output signal to input signal without feedback.

OPERATING TEMPERATURE RANGE

The range of ambient, baseplate or case temperatures through which a power supply is specified to operate safely and to perform within specified limits. See also AMBIENT TEMPERATURE, STORAGE TEMPERATURE.

OPERATIONAL AMPLIFIER (OP-AMP)

A high gain differential input device that increases the magnitude of the applied signal to produce an error voltage.

OPERATIONAL POWER SUPPLY

A power supply with a high open loop gain regulator which acts like an operational amplifier and can be programmed with passive components.

OPTO-COUPLER

A package that contains a light emitter and a photoreceptor used to transmit signals between electrically isolated circuits.

OPTO-ISOLATOR

See OPTO-COUPLER.

OSCILLATOR

A nonrotating device for producing alternating current, the output frequency of which is determined by the characteristics of the device. (IEEE Std 100-1988)

OUTPUT

The energy or information delivered from or through a circuit or device.

OUTPUT CURRENT LIMITING

A protective feature that keeps the output current of a power supply within predetermined limits during overload to prevent damage to the supply or the load.

OUTPUT FILTER

One or more discrete components used to attenuate output ripple and noise.

OUTPUT IMPEDANCE

The impedance that a power supply appears to present to its output terminals.

OUTPUT IMPEDANCE

The specified range over which the value of a stabilized output quantity (voltage or current) can be adjusted.

OUTPUT RIPPLE AND NOISE

See PERIODIC and RANDOM DEVIATION.

OUTPUT VOLTAGE

The voltage measured at the output terminals of a power supply.

OUTPUT VOLTAGE ACCURACY

The tolerance in percent of the output voltage

OVERCURRENT DEVICE

A device capable of automatically opening an electric circuit, both under predetermined overload and short-circuit conditions, either by fusing of metal or by electromechanical means.

OVERCURRENT PROTECTION

See OUTPUT CURRENT LIMITING.

OVERLOAD PROTECTION

A feature that senses and responds to current of power overload conditions. See also OUTPUT CURRENT LIMITING.

OVERSHOOT

A transient change in output voltage in excess of specified output regulation limits, which can occur when a power supply is turned on or off, or when there is a step change in line or load.

OVERVOLTAGE

1) The potential difference between the equilibrium of an electrode and that of the electrode under an imposed polarization current. 2) A voltage that exceeds specified limits.

OVERVOLTAGE PROTECTION (OVP)

A feature that senses and responds to a high voltage condition. See also OVERVOLTAGE, CROWBAR.

OVP

Abbreviation for Overvoltage Protection.

P

PAD

A conductive area on a printed circuit board used for connection to a component lead or terminal area, or as a test point.

PARALLEL

1) Term used to describe the interconnection of power sources in which like terminals are connected such that the combined currents are delivered to a single load. 2) The connection of components or circuits in a shunt configuration.

PARALLEL

The connection of two or more power sources of the same output voltage to obtain a higher output current. Special design considerations may be required for parallel operation of power sources.

PARD (periodic and random deviation):

Replaces the former term ripple of noise. PARD is the periodic and random deviation referring to the sum of all the ripple and noise components on the dc output of a power supply regardless of nature or source

PASS ELEMENT

A controlled variable resistance device, either a vacuum tube or semiconductor, in series with the dc power source used to provide regulation.

PEAK

Maximum value of a waveform reached during a particular cycle or operating time.

PEAK INVERSE VOLTAGE (PIV)

Maximum value of voltage applied in a reverse direction.

PEAK OUTPUT CURRENT

The maximum current value delivered to a load under specified pulsed conditions.

PEAK-TO-PEAK

The measured value of a waveform from peak in a positive direction to peak in a negative direction.

PERIODIC AND RANDOM DEVIATION (PARD)

The sum of all ripple and noise components measured over a specified band width and stated, unless otherwise specified, in peak-to-peak values.

PHASE ANGLE

The angle that a voltage waveform leads or lags the current waveform.

PIV

Abbreviation for Peak Inverse Voltage.

POLARITY

Property of device or circuit to have poles such as north and south or positive and negative.

POSITIVE RAIL

The most positive of the two output conductors of a power supply.

POST REGULATION

Refers to the use of a secondary regulator on a power supply output to improve line/load regulation and to attenuate ripple and noise.

POT

Abbreviation for potentiometer.

POTTING

An insulating material for encapsulating one or more circuit elements

POWER FACTOR

The ratio of true to apparent power expressed as a decimal, frequently specified as lead or lag of the current relative to voltage.

POWER FACTOR CORRECTION

1) Technique of forcing current draw to approach being in-phase with the voltage in an ac circuit. 2) Addition of capacitors to an inductive circuit to offset reactance.

POWER RATING

Power available at the output terminals of a power source based on the manufacturers specifications.

POWER SOURCE

Any device that furnishes electrical power, including a generator, cell, battery, power pack, power supply, solar cell, etc.

POWER SUPPLY

A device for the conversion of available power of one set of characteristics to another set of characteristics to meet specified requirements. Typical application of power supplies include to convert raw input power to a controlled or stabilized voltage and/or current for the operation of electronic equipment.

POWER SUPPLY CORD

An assembly of a suitable length of flexible cord provided with an attachment plug at one end.

PPM

Abbreviation for parts per million.

PREREGULATION

The initial regulation circuit in a system containing at least two cascade regulation loops.

PRIMARY-SIDE-CONTROL

A name for an off-line switching power supply with the pulse-width modulator in the primary.

PREREGULATION

A circuit electrically connected to the input or source of power to the device.

PROGRAMMABLE COEFFICIENT

The required range in control resistance to produce a one volt change in output voltage. Expressed in ohms per volt. The ratio of change in a control parameter to induce a unit change in an output, e.g., 100 ohms/volt, or 100 ohms/ampere.

PROGRAMMABLE POWER SUPPLY

A power supply with an output controlled by an applied voltage, current, resistance or digital code.

PROGRAMMING

The control of a power supply parameter, such as output voltage, by means of a control element or signal.

PULSE-WIDTH MODULATION (PWM)

A method of regulating the output voltage of a switching power supply by varying the duration, but not the frequency, of a train of pulses that drives a power switch.

PULSE-WIDTH MODULATOR (PWM)

An integrated discrete circuit used in switching-type power supplies, to control the conduction time of pulses produced by the clock.

PUSH-PULL CIRCUIT

A circuit containing two like elements that operate in 180-degree phase relationship to produce additive output components of the desired wave, with cancellation of certain unwanted products. Note: Push-pull amplifiers and push-pull oscillators are examples. (IEEE Std 100-1988)

PUSH-PULL CONVERTER

A power switching circuit that uses two or more power switches driven alternately on and off.

PWM

Variously, the abbreviation for Pulse-Width Modulation, Pulse-Width Modulator

R

RATED OUTPUT CURRENT

The maximum continuous load current a power supply is designed to provide under specified operating conditions.

RECOVERY TIME

The time required for the measured characteristic to return to within specified limits following an abnormal event.

RECTIFICATION

The process of changing an alternating current to a unidirectional current. See FULL-WAVE RECTIFIER, HALF-WAVE RECTIFIER.

RECTIFIER

A component that passes current only in one direction, e.g., a diode.

REFERENCE GROUND

Defined point in a circuit or system from which potential measurements shall be made.

REFERENCE VOLTAGE

The defined or specified voltage to which other voltages are compared.

REGULATED POWER SUPPLY

A device that maintains within specified limits a constant output voltage or current for specified changes in line, load temperature or time.

REGULATION

The process of holding constant selected parameters, the extent of which is expressed as a percent.

REGULATOR

The power supply circuit that controls or stabilizes the output parameter at a specified value.

REMOTE CONTROL

1) (general) Control of an operation from a distance: this involves a link, usually electrical, between the control device and the apparatus to be operated. Note: Remote control may be over (A) direct wire, (B) other types of interconnecting channels such as carrier-current or microwave, (C) supervisory control, or (D) mechanical means. 2) (programmable instrumentation) A method whereby a device is programmable via its electrical interface connection in order to enable the device to perform different tasks. (IEEE Std 100-1988)

REMOTE PROGRAMMING

See PROGRAMMING.

REMOTE SENSING

A technique for regulating the output voltage of a power supply at the load by connecting the regulator error-sensing leads directly to the load. Remote sensing compensates for specified maximum voltage drops in the load leads. Care should be exercised to avoid opening load handling leads to avoid damaging the power supply. Polarity must be observed when connecting sense leads to avoid damaging the system.

REPEATABILITY

The ability to duplicate results under identical operating conditions.

RESET SIGNAL

A signal used to return a circuit to a desired state.

RESISTANCE (R)

Property of a material that opposes the flow of current.

RESOLUTION

The smallest increment of change in output that can be obtained by an adjustment.

RESONANCE

1) The state in which the natural response frequency of a circuit coincides with the frequency of an applied signal, or vice versa, yielding intensified response. 2) The state in which the natural vibration frequency of a body coincides with an applied vibration force, or vice versa, yielding reinforced vibration of the body.

TECHNICAL GLOSSARY

RESONANT CIRCUIT

A circuit in which inductive and capacitive elements are in resonance at an operating frequency.

RESONANT CONVERTER

A class of converters that uses a resonant circuit as part of the regulation loop.

RESONANT FREQUENCY

The natural frequency at which a circuit oscillates or a device vibrates. In an L-C circuit, inductive and capacitive reactances are equal at the resonant frequency.

RESPONSE TIME

The time required for the output of a power supply or circuit to reach a specified fraction of its new value after step change or disturbance.

RETURN

The name for the common terminal of the output of a power supply; it carries the return current for the outputs.

REVERSE VOLTAGE PROTECTION

A circuit or circuit element that protects a power supply from damage caused by a voltage of reverse polarity applied at the input or output terminals.

RFI

Abbreviation for Radio Frequency Interference.

RIDE-THROUGH

See HOLDUP TIME

RIPPLE

The periodic ac component at the power source output harmonically related to source or switching frequencies. Unless specified otherwise, it is expressed in peak-to-peak units over a specified band width.

RIPPLE AND NOISE

See PERIODIC and RANDOM DEVIATION (PARD). See PERIODIC and RANDOM DEVIATION (PARD).

RIPPLE VOLTAGE

The periodic ac component of the dc output of a power supply.

RISE TIME

The time required for a pulse to rise from 10 percent to 90 percent of its maximum amplitude.

RMS VALUE

In text, use lower case: rms. Abbreviation for Root Mean Square Value.

ROOT MEAN SQUARE (RMS) VALUE

- 1) (periodic function) The square root of the average of the square of the value of the function taken throughout one period (IEEE Std 100-1988).
- 2) For a sine wave, $0.707 \times$ Peak Value.

S

SAFE OPERATING AREA (SOA)

A manufacturer specified power/time relationship that must be observed to prevent damage to power bipolar semiconductors.

SAFETY COMPLIANCE

Certification, recognition or approval by safety agencies such as Underwriters Laboratories Inc. (UL/U.S.A.), Canadian Standards Association (CSA), etc. See also COMPLIANCE.

SAFETY GROUND

A conductive path from a chassis, panel or case to earth to help prevent injury or damage to personnel and equipment.

SCR

Abbreviation for Silicon-Controlled Rectifier.

SECONDARY CIRCUIT

A circuit electrically isolated from the input or source of power to the device.

SECONDARY OUTPUT

An output of a switching power supply that is not sensed by the control loop.

SENSE AMPLIFIER

An amplifier which is connected to the output voltage divider to determine, or sense, the output voltage. (Bertan High Voltage)

SENSE LINE

The conductor which routes output voltage to the control loop. See also REMOTE SENSING.

SENSE LINE RETURN

The conductor which routes the voltage on the output return to the control loop. See also REMOTE SENSING.

SEQUENCING

The process that forces the order of turn on and turn off of individual outputs of a multiple output power supply.

SERIES

1) The interconnection of two or more power sources such that alternate polarity terminals are connected so their voltages sum at a load. 2) The connection of circuit components end to end to form a single current path.

SERIES PASS

A controlled active element in series with a load that is used to regulate voltage.

SERIES REGULATOR

A regulator in which the active control element is in series with the dc source and the load.

SERIES REGULATION

See LINEAR REGULATION

SETTING RANGE

The range over which the value of the stabilized output quantity may be adjusted.

SETTING TIME

The time for a power supply to stabilize within specifications after an excursion outside the input/output design parameters.

SHIELD

Partition or enclosure around components in a circuit to minimize the effects of stray magnetic and radio frequency fields. See also ENCLOSURE, ELECTROSTATIC SHIELD, FARADAY SHIELD.

SHOCK HAZARD

A potentially dangerous electrical condition that may be further defined by various industry or agency specifications.

SHORT CIRCUIT

A direct connection that provides a virtually zero resistance path for current.

SHORT CIRCUIT

The initial value of the current obtained from a power source in a circuit of negligible resistance

SHORT CIRCUIT PROTECTION

A protective feature that limits the output current of a power supply to prevent damage.

SHORT CIRCUIT TEST

A test in which the output is shorted to ensure that the short circuit current is within its specified limits.

SHUNT

1) A parallel conducting path in a circuit. 2) A low value precision resistor used to monitor current.

SHUNT REGULATOR

A linear regulator in which the control element is in parallel with the load, and in series with an impedance, to achieve constant voltage across the load.

SI

Abbreviation for System International d'Unites.

SIGNAL GROUND

The common return or reference point for analog signals.

SINE WAVE

A wave form of a single frequency alternating current whose displacement is the sine of an angle proportional to time or distance.

SLAVE

A power supply which uses the reference in another power supply, the master, as its reference

SLEW RATE

The maximum rate of change a power supply output can produce when subjected to a large step response or specified step change. The power supply is turned on.

SLOW START

A feature that ensures the smooth, controlled rise of the output voltage, and protects the switching transistors from transients when the power supply is turned on.

SNUBBER

An RC network used to reduce the rate of rise of voltage in switching applications

SOA

Abbreviation for Safe Operating Area.

SOFT STARTS

Controlled turn on to reduce inrush currents.

SOURCE

Origin of the input power, e.g., generator, utility lines, mains, batteries, etc.

TECHNICAL GLOSSARY

T

SOURCE VOLTAGE EFFECT

The change in stabilized output produced by a specified primary source voltage change.

STABILITY

1) The percent change in output parameter as a function of time, with all other factors constant, following a specified warm-up period. 2) The ability to stay on a given frequency or in a given state without undesired variation.

STANDOFF

A mechanical support, which may be an insulator, used to connect and support a wire or device away from the mounting surface.

STEP-DOWN TRANSFORMER

(power and distribution transformer) A transformer in which the power transfer is from a higher voltage source circuit to a lower voltage circuit. (IEEE Std 100-1988)

STEP-UP TRANSFORMER

(power and distribution transformer) A transformer in which the power transfer is from a lower voltage source circuit to a higher voltage circuit. (IEEE Std 100-1988)

STORAGE TEMPERATURE

The range of ambient temperatures through which an inoperative power supply can remain in storage without degrading its subsequent operation. See also AMBIENT TEMPERATURE, OPERATING TEMPERATURE.

SUMMING POINT

The point at which two or more inputs of an operational amplifier are algebraically added.

SWITCHING FREQUENCY

The rate at which the dc voltage is switched in a converter or power supply.

SWITCHING FREQUENCY

A switching circuit that operates in a closed loop system to regulate the power supply output.

SYNCHRONOUS RECTIFICATION

A rectification scheme in a switching power supply in which a FET or bipolar transistor is substituted for the rectifier diode to improve efficiency.

SYSTEME INTERNATIONAL d'UNITES (SI)

The International System of Units comprised of Base Units, Supplementary Units and Derived Units.

TRANSIENT RESPONSE TIME

The room temperature or temperature of the still air surrounding the power supply, with the supply operating.

TEMPERATURE COEFFICIENT

The average percent change in output voltage per degree centigrade change in ambient temperature over a specified temperature range. See also AMBIENT TEMPERATURE.

TEMPERATURE DERATING

The amount by which power source or component ratings are decreased to permit operation at elevated temperatures.

TEMPERATURE EFFECT

See TEMPERATURE COEFFICIENT.

TEMPERATURE RANGE, OPERATING

See OPERATING TEMPERATURE RANGE

THERMAL PROTECTION

A protective feature that shuts down a power supply if its internal temperature exceeds a predetermined limit.

THREE TERMINAL REGULATOR

A power integrated circuit in a 3-terminal standard transistor package. It can be either a series or shunt regulator IC.

TIME CONSTANT

Time period required for the voltage of a capacitor in an RC circuit to increase to 63.2 percent of maximum value or decrease to 36.7 percent of maximum value.

TOLERANCE

Measured or specified percentage variation from nominal.

TOTAL EFFECT

The change in a stabilized output produced by concurrent worst case changes in all influence quantities within their rated range.

TRACE

A conducting path on a printed circuit board.

TRACKING

A characteristic of a multiple-output power supply that describes the changes in the voltage of one output with respect to changes in the voltage or load of another.

TRACKING REGULATOR

A plus or minus two-output supply in which one output tracks the other.

TRANSIENT

An excursion in a given parameter, typically associated with input voltage or output loading.

TRANSIENT EFFECT

The result of a step change in an influence quantity on the steady state values of a circuit.

TRANSIENT RECOVERY TIME

The time required for the output voltage of a power supply to settle within specified output accuracy limits following a transient.

TRANSIENT RESPONSE

Response of a circuit to a sudden change in an input or output quantity.

TRANSIENT RESPONSE TIME

The interval between the time a transient is introduced and the time it returns and remains within a specified amplitude range.

TTL

Abbreviation for transistor-transistor logic

U**UL**

Abbreviation for Underwriters Laboratories Incorporated.

UNDERSHOOT

A transient change in output voltage in excess of specified output regulation limits. See **OVERSHOOT**.

UNDERVOLTAGE PROTECTION

A circuit that inhibits the power supply when output voltage falls below a specified minimum.

UNDERWRITERS LABORATORIES INCORPORATED (UL)

American association chartered to test and evaluate products, including power sources. The group has four locations so an applicant can interact with the office closest in the country to his/her own location.

UNINTERRUPTIBLE POWER SUPPLY (UPS)

A type of power supply designed to support the load for specified periods when the line varies outside specified limits. See also **OFF LINE POWER SUPPLY**, **ON LINE POWER SUPPLY**.

UPS

Abbreviation for Uninterruptible Power Supply.

V**VARISTOR**

A two electrode semiconductor device having a voltage-dependent nonlinear resistance.

VDE

Abbreviation for Verband Deutscher Elektrotechniker.

VOLTAGE DIVIDER

Tapped or series resistance or impedance across a source voltage to produce multiple voltages.

VOLTAGE DOUBLER

See **VOLTAGE MULTIPLIER**.

VOLTAGE DROP

Difference in potential between two points in a passive component or circuit.

VOLTAGE LIMIT

Maximum or minimum value in a voltage range.

VOLTAGE LIMITING

Bounding circuit used to set specified maximum or minimum voltage levels.

VOLTAGE MODE

The functioning of a power supply so as to produce a stabilized output voltage.

VOLTAGE MONITOR

A circuit or device that determines whether or not an output voltage is within some specified limits.

VOLTAGE MULTIPLIER

Rectifier circuits that produce an output voltage at a given multiple greater than input voltage, usually doubling, tripling, or quadrupling.

VOLTAGE REGULATION

The process of holding voltage constant between selected parameters, the extent of which is expressed as a percent. See also REGULATION.

VOLTAGE SOURCE

A power source that tends to deliver constant voltage.

VOLTAGE STABILIZATION

The use of a circuit or device to hold constant an output voltage within given limits

VOLT (V)

Unit of measurement of electromotive force or potential difference. Symbol E, in electricity; symbol V in semiconductor circuits.

W**WARMUP**

Process of approaching thermal equilibrium after turn on.

WARMUP DRIFT

The change in output voltage of a power source from turn on until it reaches thermal equilibrium at specified operating conditions.

WARMUP EFFECT

Magnitude of change of stabilized output quantities during warmup time.

WARMUP TIME

The time required after a power supply is initially turned on before it operates according to specified performance limits.

WATT (W)

Unit of measure of power equal to 1 joule/sec. ($W=EI$)

WEBER (Wb)

The SI unit of magnetic flux equal to 10⁸ maxwells. The amount of flux that will induce 1 volt/turn of wire as the flux is reduced at a constant rate to zero over a period of one second.

WITHSTAND VOLTAGE

The specified operating voltage, or range of voltages, of a component, device or cell.

WORKING VOLTAGE

The specified operating voltage, or range of voltages, of a component, device or cell.

WORST CASE CONDITION

A set of conditions where the combined influences on a system or device are most detrimental.

X**X-RAY TUBE**

A vacuum tube designed for producing X-rays by accelerating electrons to a high velocity by means of an electrostatic field and then suddenly stopping them by collision with a target. (IEEE Std 100-1988)

Z**ZENER DIODE**

1) A diode that makes use of the breakdown properties of a PN junction. If a reverse voltage across the diode is progressively increased, a point will be reached when the current will greatly increase beyond its normal cut-off value to maintain a relatively constant voltage. Either voltage point is called the Zener voltage. 2) The breakdown may be either the lower voltage Zener effect or the higher voltage avalanche effect.

ZENER VOLTAGE

The reverse voltage at which breakdown occurs in a zener diode.

A

ABSORBED DOSE

Energy transferred/deposited from ionizing radiation per unit mass of irradiated material; expressed in rad or gray.

ACTUAL FOCAL SPOT SIZE

Area on the anode target that is exposed to electrons from the tube current.

AIR KERMA

A measure of the amount of radiation energy, in the unit of joules (J), actually deposited in or absorbed in a unit mass (kg) of air. Therefore, the quantity, kerma, is expressed in the units of J/kg which is also the radiation unit, the gray (G).

ANATOMIC PROGRAMMING RADIOGRAPHY (APR)

Technique by which graphics representing images of normal skeletal anatomy (human/animal) on the console guide the technologist in selection of a desired kVp and mAs by just selecting the particular body part (human/animal) to be examined.

ANGIOGRAPHY

Fluoroscopic process by which the X-Ray examination is guided toward visualization of blood vessels.

APERTURE

Fixed collimation of a diagnostic X-Ray tube, as in an aperture diaphragm.

AUTOMATIC BRIGHTNESS CONTROL (ABC)

Feature on a fluoroscopy system that allows the radiologist to select an image-brightness level that is subsequently maintained automatically by varying the kVp, mAs, or both.

AUTOMATIC EXPOSURE CONTROL (AEC)

Feature that determines radiation exposure during radiography in most X-Ray imaging systems.

B

BACKSCATTER RADIATION

X-Rays that have interacted with an object and are deflected backward.

BEAM LIMITING DEVICE

Device that provides a means of restricting the size of an X-Ray field.

BUCKY

A Bucky is a device that moves the grid while the X-Ray is being taken. The motion keeps the lead strips from being seen on the X-Ray picture reducing noise giving clearer image for diagnosis.

C

COLLIMATOR

Device used to restrict X-Ray beam size and shape.

COMPUTED RADIOGRAPHY (CR)

Radiographic technique that uses a photostimulable phosphor (storage phosphor) as the image receptor. The resultant image can be digitized, stored and shared on computers.

COMPUTED TOMOGRAPHY (CT)

Creation of a cross sectional tomographic section of the body by rotating an X-Ray fan beam and detector array around the patient, and using computed reconstruction to process the image.

CONTRAST

Degree of difference between the light and dark areas of a radiograph.

CONTRAST MEDIUM

Agent that enhances differences between anatomic structures.

D

DATA ACQUISITION SYSTEM (DAS)

Computer-controlled electronic amplifier and switching device to which the signal from each radiation detector of a multi-slice spiral computed tomographic scanning system is connected.

DETECTIVE QUANTUM EFFICIENCY (DQE)

Describes how effectively an X-Ray imaging system can produce an image with a high signal-to-noise ratio (SNR) relative to an ideal detector.

DETECTOR ARRAY

Group of detectors and the interspace material to separate them; the image receptor in computed tomography.

DIGITAL-IMAGING-AND-COMMUNICATION-IN-MEDICINE-DICOM

Standard that enables imaging systems from different manufacturers to communicate.

DIGITAL-FLUOROSCOPY-DF

Digital X-Ray imaging system that produces a series of dynamic images with the use of an area X-Ray beam and an image intensifier or flat panel detector.

DIGITAL RADIOGRAPHY (DR)

Digital X-Ray imaging where digital X-ray sensors including flat panel detectors are used instead of traditional photographic film for static radiographs.

DOSE AREA PRODUCT (DAP)

Is a multiplication of the dose and the area exposed, often expressed in Gy.cm². Modern X-Ray systems are fitted with a DAP meter, able to record accumulated DAP during an examination.

DOSIMETER

Instrument that detects and measures exposure to ionizing radiation.

E

EFFECTIVE FOCAL SPOT SIZE

Area projected onto the patient and image receptor.

ELECTRON VOLTS (EV)

Is the amount of energy gained by the charge of a single electron moved across an electric potential difference of one volt.

ENERGY SUBTRACTION

Technique that uses the two X-Ray beam energies alternately to provide a subtraction image that results from differences in photo electric interaction.

EXPOSURE

Measure of the ionization produced in air by X-Rays or gamma rays. Quantity of radiation intensity expressed in Roentgen, Coulombs per kilogram or air kerma.

F

FALLING LOAD GENERATOR

Design in which exposure factors are adjusted automatically to the highest mA at the shortest exposure time allowed by the high voltage generator.

FAN BEAM

X-Ray beam pattern used in computed tomography projected as a slit.

FILTRATION

Removal of low-energy X-Rays from the useful beam with aluminum or another metal. It results in increased beam quality and reduce patient dose.

FLUOROSCOPY

Imaging modality that provides a continuous image of the motion of internal structures while the X-Ray tube is energized. Real time imaging.

FOCAL SPOT

Region of the anode target in which electrons interact to produce X-Rays.

G

GRID (ANTISCATTER GRID)

Device used to reduce the intensity of scatter radiation in the remnant X-Ray beam.

H

HALF VALUE LAYER (HVL)

Thickness of the X-Ray absorber necessary to reduce the an X-Ray beam to half of its original intensity.

HARD X-RAY

X-Ray that has high penetrability and therefore is of high quality.

I

IMAGE INTENSIFIER

An electronic device used to produce a fluoroscopic image with a low-radiation exposure. A beam of X-Rays passing through the patient is converted into a pattern of electrons in a vacuum tube.

INHERENT FILTRATION

Filtration of useful X-Ray beams provided by the permanently installed components of an X-Ray tube housing assembly and the glass window of an X-Ray tube insert.

INVERSE SQUARE LAW

Law that states that the intensity of radiation at a location is inversely proportional to the square of its distance from the source of radiation.

IONIZATION CHAMBER

The Ionization chamber is the simplest of all gas-filled radiation detectors, and is used for the detection or measurement of ionizing radiation.

K

KILOVOLT PEAK (KVP)

Measurement of maximum electrical potential across an X-Ray tube; expressed in kilovolts.

L

LEAKAGE RADIATION

Secondary radiation emitted through the tube housing.

M

MAMMOGRAPHY

Radiographic examination of the breast using low kilovoltage.

MILLIAMPERE (MA)

Measurement of X-Ray tube current.

MILLIAMPERE SECOND (MAS)

Product of exposure time and X-Ray tube current.

MOVING GRID

Grid that moves during the X-Ray exposure. Commonly found in a bucky.

MULTI SLICE COMPUTED TOMOGRAPHY

Imaging modality that used two detector arrays to produce two spiral slices at the same time.

O

OFF FOCUS RADIATION

X-Rays produced in the X-Ray tube anode but not at the focal spot.

OBJECT TO IMAGE RECEPTOR DISTANCE (OID)

Distance from the image receptor to the object that is to be imaged.

P

PHOTOELECTRIC EFFECT

The emission of electrons from a material, such as a metal, as a result of being struck by photons.

PHOTOMULTIPLIER TUBE (PMT)

An electron tube that converts visible light into an electrical signal.

PHOTON

Electromagnetic radiation that has neither mass nor electric charge but interacts with matter as though it is a particle; X-Rays and gamma rays.

Q

QUANTUM

An X-Ray photon.

R

RADIATION ABSORBED DOSE (RAD)

Special unit for absorbed dose and air kerma.
1 rad = 100 erg/g = 0.01 Gy.

RADIATION QUALITY

Relative penetrability of an X-Ray beam determined by its average energy; usually measured by half-value layer or kilovolt peak.

RADIOGRAPHIC TECHNIQUE

Combination of setting selected on the control panel of the X-Ray imaging system to produce a quality image on the radiograph.

RADIOGRAPHY

Imaging modality that uses X-Ray film and/or detector and usually an X-Ray tube to provide fixed (static) images.

S

SCATTER RADIATION

X-Rays scattered back in the direction of the incident X-Ray beam.

SOFT X-RAY

X-Rays that has low penetrability and therefore low quality.

SOURCE TO IMAGE RECEPTOR DISTANCE (SID)

Distance from the X-Ray tube to the image receptor.

SPATIAL RESOLUTION

Ability to image small objects that have high subject contrast.

STARTER (TUBE STARTER)

Rotating anode X-Ray tubes utilize an induction motor to rotate the anode assembly. A starter or motor controller is used to apply power to the X-Ray tube motor for rotation.

T

TOMOGRAPHY

A sectional image is made through a body by moving an X-Ray source and the film in opposite directions during the exposure. Structures in the focal plane appear sharper, while structures in other planes appear blurred.

TOTAL FILTRATION

Inherent filtration of the X-Ray tube plus added filtration.

X

X-RAY

Penetrating, ionizing electromagnetic radiation that has a wavelength much shorter than that of visible light.

Spellman USA and Corporate HQ

475 Wireless Blvd.
Hauppauge, NY 11788
United States
tel: +1 631-630-3000
fax: +1 631-435-1620
email: sales@spellmanhv.com

Spellman Valhalla NY USA

One Commerce Park
Valhalla, NY 10595
United States
tel: +1 914-686-3600
fax: +1 914-686-5424

Spellman UK

Broomers Hill Park #14, Broomers Hill
Pulborough, West Sussex,
United Kingdom RH20 2RY
tel: +44 (0) 1798 877000
fax: +44 (0) 1798 872479

Spellman Japan

Kano Bldg. 5F, 1-26-7 Nishigotanda,
Shinagawa-ku, Tokyo 141-0031 Japan
tel: +81 (0) 3-5436-9810
fax: +81 (0) 3-5436-9811

Spellman China

Spellman High Voltage Electronics (SIP) Co Ltd.
No. 86 Jinjiang Road,
Suzhou Industrial Park 215217 China
tel: +86-512-67630010
fax: +86-512-67630030

Spellman High Voltage Korea Co.,Ltd.

#B-720, BRC Smart Valley,
Song Do Mirae-ro 30,
Yeonsu-Gu, Incheon, Korea 406-081
tel: +82 32-719-2300
fax: +82 32-720-4300

Spellman de Mexico – Plant 2

Avenida Pedregal # 2 Esquina
Avenida Chapultepec
Parque Industrial FINSA Oriente
Matamoros, Tamps., Mexico 87340
tel. +52 868 150-1200

Spellman de Mexico – Plant 3

Avenida Chapultepec # 101 Esquina
Avenida Horizonte
Parque Industrial FINSA Oriente
Matamoros, Tamps., Mexico 87340
tel. +52 868 150-1200

Spellman High Voltage GmbH

Josef-Baumann-Straße 23
44805 Bochum
Germany
tel: +49 (0) 234 87906-0



www.spellmanhv.com
e-mail: sales@spellmanhv.com